



# Afghanistan

## Ordnance Identification Guide

*This guide provides information to facilitate international unexploded ordnance (UXO) awareness and identification. This guide is not intended for use by Explosive Ordnance Disposal (EOD) technicians. Rather, it is designed for other personnel who, of necessity, are trying to identify ordnance in the absence of trained EOD military professionals.*



Prepared By:  
Naval Explosive Ordnance  
Disposal Technology Division

Indian Head, Maryland

**Volume 1 of 2**

18 August 2004

**DISTRIBUTION STATEMENT A:**

Approved for public release; distribution is unlimited.

# TABLE OF CONTENTS

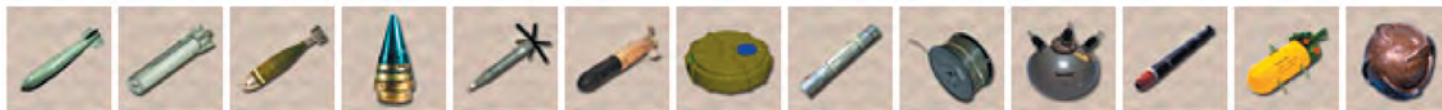

## Introduction

Miscellaneous Information .....	3
Disclaimer/Warning .....	3
Contact Information .....	3

## Language Identification Chart

.....	4
-------	---

## Soviet Ordnance Terms

Transliteration of Russian Alphabet .....	7
Ammunition Filler Codes .....	8
General Ordnance Markings .....	9
Projectile Suffixes .....	10
Soviet Projectile Weight Classifications .....	10
Caliber of using weapons identified by third- component numbers of the model code.....	11
Model Markings for Mines .....	11
Typical Mine Markings .....	12
Typical Bomb Markings .....	12

## Foreign Projectile Terms

Russian .....	13
Arabic .....	16
Chinese .....	22

## Markings

Alphanumeric markings .....	25
Graphic Symbols .....	29
Map of Afghanistan .....	30

## Safety and General Information

Bomb .....	31
Dispenser .....	33

Projectile .....	34
Grenade .....	36
Fuze .....	38
Rocket .....	39
Guided Missile .....	40
Landmine .....	42
Naval Mine .....	45
Depth Charge, Sound Signal & Marker .....	47
Scatterable .....	48

## Ordnance Information

## Pages

### Volume 1

Bombs .....	1 – 25
Dispensers, Clusters & Launchers .....	1 – 20
Projectiles .....	1 – 131

### Volume 2

Fuze/Firing Devices .....	1 – 93
Grenades .....	1 – 12
Rockets .....	1 – 39
Guided Missiles .....	1 – 25
Landmines .....	1 – 40
Pyrotechnics .....	1 – 5
Improvised Explosive Devices .....	1 – 2
Misc Explosive Devices .....	1 – 5
Depth Charge or Other Underwater .....	1 – 1
Scatterable .....	1 – 14

# INTRODUCTION

---

## MISCELLANEOUS INFORMATION

This guide provides ordnance identification information for over 800 ordnance items. The Afghanistan Ordnance Identification Guide provides information to facilitate international unexploded ordnance (UXO) awareness and identification. This guide is not intended for use by Explosive Ordnance Disposal (EOD) technicians. Rather, it is designed for other personnel who, of necessity, are trying to identify ordnance in the absence of trained EOD military professionals.

- Each weapon category is sorted by diameter (mm).
- Due to space restrictions, a maximum of seven (7) "ordnance used with" entries will be shown. On certain ordnance this list will be incomplete.
- If available, the N.E.W. (Net Explosive Weight) is listed underneath the "ordnance used with" section.

## DISCLAIMER/WARNING

Demining/unexploded ordnance (UXO) clearance operations are extremely hazardous and subject personnel involved to significant risk of serious injury or death. By its very nature, UXO is unpredictable and each incident presents unique problems that cannot be addressed in a general guide. While this product provides the best available information for identification of ordnance, the developers accept no legal responsibility for damage or injury to personnel or property resulting from its use.

The safe and effective use of the information in this guide assumes a certain level of technical competence in its target audience. At a minimum, users must be trained in general ordnance explosive safety and demolition procedures.

Use this information at your own risk!



## CONTACT INFORMATION

EOD Technical Support Center: **1-877-EOD-INFO (363-4636)**  
COMM: **301-744-4069/4070/4071/4072/4076** or **DSN 354-XXXX**  
Internet web page: **<https://naveodtechdiv.navsea.navy.mil>**  
SIPRNET: **<http://tsc.jeodnet.smil.mil>**

*Please send comments and suggestions to: [TSC@jeodnet.smil.mil](mailto:TSC@jeodnet.smil.mil)*

## LANGUAGE IDENTIFICATION CHART

املأ هذا المربع إذا كنت تقرأ أو تتحدث العربية. ....	Arabic
Խնդրում ենք նշում կատարել այս քառակուսում, եթե խոսում կամ կարդում եք հայերեն: .....	Armenian
যদি আপনি বাংলা পড়েন বা বলেন তা হলে এই বাক্সে দাগ দিন। .....	Bengali
សូមញាតក្នុងប្រអប់នេះ ចំអុកអាន ឬនិយាយភាសា ខ្មែរ ។ .....	Cambodian
Matka i kakhon komu un taitai pat un sang i Chamorro. ....	Chamorro
如果您具有中文閱讀和會話能力，請在本空格內標上X記號。 .....	Chinese
Make kazyé sa a si ou li oswa ou pale kreyòl ayisyen. ....	Creole
Označite ovaj kvadratić ako čitate ili govorite hrvatski jezik. . .	Croatian (Serbo-Croatian)
Zaškrtněte tuto kolonku, pokud čtete a hovoříte česky. ....	Czech
Kruis dit vakje aan als u Nederlands kunt lezen of spreken. ....	Dutch
Mark this box if you read or speak English. ....	English
اگر خواندن و نوشتن فارسی بدرهستین، این مربع را علامت بگذارید. ....	Farsi

## LANGUAGE IDENTIFICATION CHART

---

Cocher ici si vous lisez ou parlez le français. .... **French**

Kreuzen Sie dieses Kästchen an, wenn Sie Deutsch lesen oder sprechen. .... **German**

Σημειώστε αυτό το πλαίσιο αν διαβάζετε ή μιλάτε Ελληνικά. .... **Greek**

अगर आप हिन्दी बोलते या पढ़ सकते हैं तो इस गोले पर चिह्न लगाएँ। .... **Hindi**

Kos lub voj no yog koj paub twm thiab hais lus Hmoob. .... **Hmong**

Jelölje meg ezt a kockát, ha megérti vagy beszéli a magyar nyelvet. .... **Hungarian**

Markaam daytoy nga kahon no makabasa wenno makasaoka iti Ilocano. .... **Ilocano**

Marchi questa casella se legge o parla italiano. .... **Italian**

日本語を讀んだり、話せる場合はここに印を付けてください。 .... **Japanese**

한국어를 읽거나 말할 수 있으면 이 칸에 표시하십시오. .... **Korean**

ໃຫ້ໝາຍໃສ່ຊ່ອງນີ້ ຖ້າທ່ານອ່ານຫຼືປາກົນພາສາລາວ. .... **Laotian**

Zaznacz tę kratkę jeżeli czyta Pan/Pani lub mówi po polsku. .... **Polish**

Assinale este quadrado se voce lê ou fala Português. .... **Portuguese**

## LANGUAGE IDENTIFICATION CHART

Însemnați această căsuță dacă citiți sau vorbiți Românește. .... **Romanian**

Пометьте этот квадратик, если вы читаете или говорите по-русски. .... **Russian**

Ma'a pe fa'aiologa le pusa lea pe afai e te faitau pe tusitusi i le gagana Samoa. .... **Samoa**

Обележите овај квадратик уколико читате или говорите српски језик. .... **Serbian**

Označte tento štvorček, ak viete čítať alebo hovoriť po slovensky. .... **Slovak**

Marque esta casilla si lee o habla español. .... **Spanish**

Markahan ang kahon na ito kung ikaw ay nagsasalita o nagbabasa ng Tagalog. .... **Tagalog**

ให้กาเครื่องหมายลงในช่องถ้าท่านอ่านหรือพูดภาษาไทย. .... **Thai**

Faka'ilonga'i 'ae puha ko'eni kapau 'oku te lau pe lea 'ae lea fakatonga. .... **Tongan**

Відмітьте цю клітинку, якщо ви читаете або говорите українською мовою. .... **Ukrainian**

اگر آپ اردو پڑھتے یا بولتے ہیں تو اس خانہ میں نشان لگائیں. .... **Urdu**

Xin đánh dấu vào ô này nếu quý biết đọc và nói được Việt Ngữ. .... **Vietnamese**

צייכנט דעם קעסטל אויב איר שרייבט אדער ליינט אידיש. .... **Yiddish**

## SOVIET ORDNANCE TERMS

### Transliteration of Russian Alphabet

Russian		English		Russian		English		Russian		English	
А	а	A	a	Л	л	L	l	Ц	ц	Ts	ts
Б	б	B	b	М	м	M	m	Ч	ч	Ch	ch
В	в	V	v	Н	н	N	n	Ш	ш	Sc	sh
Г	г	G	g	О	о	O	o	Щ	щ	Shch	shch
Д	д	D	d	П	п	P	p	Ъ	ъ	(")	(")
Е	е	Ye, E	ye, e <sup>1</sup>	Р	р	R	r	Ы	ы	Y	y
Ж	ж	Zh	zh	С	с	S	s	Ь	ь	(')	(')
З	з	Z	z	Т	т	T	t	Э	э	E	e
И	и	I	i	У	у	U	u	Ю	ю	Yu	yu
Й	й	Y	y	Ф	ф	F	f	Я	я	Ya	ya
К	к	K	k	Х	х	Kh	kh				

<sup>1</sup>ye initially, after vowels, and after Ъ, ь; e elsewhere. When written as ë in Russian, translate as yë or ë. Use of diacritical marks is preferred, but such marks may be omitted when expediency dictates.

# SOVIET ORDNANCE TERMS

## Ammunition Filler Codes

Marking	Meaning
A	Amatol (100% Ammonium Nitrate)
A-40	Amatol (40% Ammonium Nitrate, 60% TNT)
AT-40	Amatol (40% Ammonium Nitrate, 60% TNT Pressed)
A-80	Amatol (80% Ammonium Nitrate, 20% TNT)
AT-90	Amatol (90% Ammonium Nitrate, 10% TNT)
ATФ 40	TNT (40% Ammonium Nitrate, 60% TNT Pressed)
A-IX-1	RDX 94%, Wax 6%
A-IX-2	RDX 73%, Aluminum 23%, Wax 4%
A-IX-20	RDX 78%, Aluminum 19%, Wax 3%
A-IX-II	RDX with unknown suffix "I=P"
ДБ	Dinitrobenzol
ДБТ	Dinitrobenzene and TNT
Г	Hexogen (cyclonite, RDX)
ГАИ-30	RDX 30%
З	Incendiary
М	Picric Acid
МС	TNT, Aluminum, RDX
К-1	TNT 70%, Dinitrobenzene 30%
К-2	TNT 80%, Dinitrobenzene 20%
ОКТОГЕН	HMX
ОКФОЛ	HMX 95%, wax 5% (normal composition)
ОКТОЛ	HMX and TNT
ОЛ	HMX 95%, wax 5% (normal composition)
ПВВ-5А	Plastic Explosive

Marking	Meaning
T	Trotyl (TNT)
T-80	TNT 70%, RDX 30%
ТТ	TNT and RDX
ТТ-30	TNT 30%, Hexogen (RDX) 70%
ТТ-50	TNT 50%, Hexogen (RDX) 50%
ТТАФ-5	TNT 40%, RDX 40%, Aluminum 20%
ТТАГ-5	TNT 60%, RDX 20%, Aluminum 15%, Wax 5%
ТД-42	TNT 42%, Dinitronaphthalene 58%
ТД-50	TNT 50%, Dinitronaphthalene 50%
ТДУ	TNT with spotting charge
ТС	TNT sulfite
III	Schneiderite (Ammonium Nitrate 88%, Napthalene)
IIIТ	Schneiderite and TNT
P-4	White and Yellow Phosphorus
P-5	Mustard gas (H)
PC	Lewisite gas (L)
PIO	Phosgene gas (CG)
P-15	Adamsite gas (DM)
P-2	Hydrogen Cyanide gas (AC)
P-35	Sarin gas (GB)
P-43	Lewisite gas (L)
P-55	Soman gas (GD)
P-74	Mustard gas (H)
PK-7	Mustard/Lewisite mixture (H+L)



# SOVIET ORDNANCE TERMS

## General Ordnance Markings

Cyrillic	English	Meaning
А	A	Propaganda or fragmentation
Б	B	Armor-Piercing
З	Z	Incendiary
Р	R	Tracer
БР	BR	Armor-Piercing, Tracer
БЗ	BZ	Armor-Piercing, Incendiary
БЗА	BZA	Armor-Piercing, Incendiary (improved)
БЗР	BZR	Armor-Piercing, Incendiary Tracer
БМ	BM	Armor-Piercing Discarding Sabot (fin or Spin Stabilized)
БП	BP	HEAT Spin Stabilized
БК	BK	HEAT Fin Stabilized
Д	D	Smoke
ДЦ	DTs	Target Marker Smoke
О	O	Fragmentation (Oskolochno)
Ф	F	High Explosive (Fugaasynmi)
ОФ	OF	Fragmentation, High Explosive
Г	G	Concrete-Piercing
ОГ	OG	Fragmentation (launched grenades)
ОФР	OFR	Fragmentation, High Explosive, Tracer
ОФЗТ	OFZT	Fragmentation, High Explosive, Incendiary, Tracer
ОР	OR	Fragmentation, Tracer
ОЗ	OZ	Fragmentation, Incendiary
ОХ	OKh	Fragmentation, Gas

Cyrillic	English	Meaning
ПБР	PBR	Armor-Piercing, Target Practice
ПГ	PG	HEAT (launched grenades)
ПУ	PU	Target Practice
РПО	RPO	Infantry Flame Weapon
С	S	Illumination
СП	SP	Solid Shot, Armor-Piercing
Ш	Sh	Shrapnel
Щ	Shch	Canister
Х	Kh	Gas
ИНЕРТ	INERT	Inert
МАКЕТ	MAKET	Model
ОСКОЛ	OSKOL	Fragmentation
ПРАКТ	PRACT	Practice

## SOVIET ORDNANCE TERMS

### Projectile Suffixes

Cyrillic	English	Meaning
А	A	Cast Iron
Б	B	Improved Projectile (Mostly AP Types)
Д	D	Improved Projectile (Mostly AP Types)
ДУ	DU	Improved Projectile (Mostly Frag Types)
Ж	Zh	Sintered Iron Rotating Band
К	K	Improved Projectile (Mostly AP Types)
М	M	Usually HEAT Projectile (Copper Liner)
Н	N	Improved Projectile (Mostly Frag)
П	P	Usually Improved HVAP Projectile
ПК	PK	Usually Improved HVAP Projectile
С	S	Improved HEAT Projectile
СП	SP	Improved AP Projectile
У	U	Usually Improved AP Projectile
УМ	UM	Improved HEAT Projectile

### Soviet Projectile Weight Classifications

Symbol	Meaning
ПГ	Greater than 3% below standard
----	2.33% to 3% below standard
---	1.66% to 2.33% below standard
--	1% to 1.66% below standard
-	0.33% to 1% below standard
Н	0.33% below to 0.33% above standard
+	0.33% to 1% above standard
++	1% to 1.66% above standard
+++	1.66% to 2.33% above standard
++++	2.33% to 3% above standard
ТЖ	Greater than 3% above standard

## SOVIET ORDNANCE TERMS

Caliber of using weapons identified by third-component numbers of the model code.

Third-Component Number	Weapon Caliber	Third-Component Number	Weapon Caliber
132	25-mm	883	107-mm (recoilless gun)
167	37-mm	1*, 3*, 5*, 6*	115-mm
240, 243	45-mm	843	120-mm (mortar)
822	50-mm (mortar)	3*, 5*, 6*, 460, 462, 463, 471, 472	122-mm
271, 281	57-mm	482	130-mm
343, 344, 350, 352, 353, 354, 355, 356, 361, 363, 364	76-mm	501, 530, 533, 534, 536, 540, 542, 543, 544, 545, 551	152-mm
832	82-mm (mortar)	852, 853	160-mm (mortar)
881	82-mm (recoilless gun)	23*, 572	180-mm
1*, 365, 366, 367	85-mm	620, 621, 624, 625	203-mm
412, 415	100-mm	864	240-mm (mortar)
420, 422, 423, 425	107-mm	674, 675	280-mm
841	107-mm (mortar)	724	305-mm

Model Markings for Mines

Cyrillic	English	Meaning
Б	B	Large or Paper
В	V	Fuze
Д	D	Wooden
Э	E	Electrical
З	Z	Obstacle
К	K	Shaped Charge
М	M	Mine, Metal, or Improved
Н	N	Anti-Handling, Tread Operated, or Directional
О	O	Fragmentation or Obstacle
П	P	Anti-Personnel or Plastic
С	S	Self Destruct or Booby-Trap
Т	T	Anti-Tank
У	U	Training
Ф	F	Explosive, FAE, or Dropped
Х	Kh	Chemical
Ч	Ch	Clockwork or Timer
Ш	Sh	Tilt Rod
Я	Ya	Box (Old Designation) or Anchored
Р	R	Water

\* Denotes an observed deviation from established three-number system.

**EXAMPLE: OF-412=Fragmentation, High Explosive, 100mm**

## SOVIET ORDNANCE TERMS

### Typical Mine Markings

Cyrillic	English	Meaning
МВЗ	MVZ	Mine Fuze Pressure Operated
ЯМ	YaM	Anti-Tank Mine Wooden (Old Designation)
МПМ	MPM	Mine-Bullet-Improved
ЭХЗ	EkhZ	Electric Chemical Fuze
ЧЗ	ChZ	Clockwork/Timer Fuze
МВЧ	MVCh	Clockwork Mine Fuze
УВ	UV	Pull Fuze
МВШ	MVSh	Mine Fuze Tilt-Rod
ОЗМ	OZM	Fragmentation Obstacle Mine
ТМД-Б	TMD-B	Anti-Tank Wooden Cased
ЗТ	ZT	Time Fuze Igniter
МУВ	MUV	Mine Fuze Pull
ТМК	TMK	Anti-Tank Mine With Shaped Charge
ПМД	PMD	Anti-Personnel Mine Wooden Cased
ПОМЗ	POMZ	Anti-Personnel Mine Obstacle
ПМН	PMN	Anti-Personnel Mine Tread Operated
ВПФ	VPF	All Ways Acting Fuze
ТМБ	TMB	Anti-Tank Mine Paper Cased
ТМ	TM	Anti-Tank Mine
МВ	MV	Mine Fuze Pressure Operated
МВМ	MVM	Mine Fuze Improved
МВН	MVN	Mine Fuze Magnetic Influence
ТМН	TMN	Anti-Tank Mine With Anti-Handling Fuze
МОН	MON	Mine Fragmentation Directional

### Typical Bomb Markings

Cyrillic	English	Meaning
ФАБ	FAB	General Purpose, High Explosive
ОФАБ	OFAB	General Purpose, Frag-HE
БРАБ	BRAB	Semi-Armor Piercing
БЕТАБ	BETAB	Armor Piercing
ПТАБ	PTAB	Anti-Tank
МАБ	MAB	Light-Case Blast
АО	AO	Fragmentation
ЗАБ	ZAB	Incendiary
РРАБ	RRAB	Container (Cluster)
ХАБ	KhAB or ChAB	Chemical
КРАБ	KRAB	Toxic Smoke
ДАБ	DAB	Incendiary Smoke
ОДАБ	ODAB	Fuel Air Explosive
ФОТАБ	FOTAB	Photo Flash
АНАБ	ANAB	Marker Float
АБ	AB	Propoganda
ДС	DS	Rocket Assisted
АОХ	AOKh or AOCh	Frag-Chemical
САБ	SAB	Flare
АГИТАБ	AGITAB	Leaflet

## FOREIGN ORDNANCE TERMS

---

### Russian

Аматол	-----	<b>Amatol</b>
Боевой	-----	<b>Live</b>
Боевые припасы	-----	<b>Ammunition</b>
Бомба	-----	<b>Bomb</b>
Бронебойный	-----	<b>Armor-piercing</b>
Взведенный	-----	<b>Armed</b>
Взрыв	-----	<b>Explosion; burst</b>
Взрыватель	-----	<b>Fuze</b>
Радиовзрыватель	-----	<b>Proximity fuze</b>
Взрывчатое вещество (ВВ)	-----	<b>Explosive</b>
Головное зарядное отделение	-----	<b>Warhead</b>
Граната	-----	<b>Grenade; shell</b>
Детонатор	-----	<b>Detonator</b>
Дистанционная трубка	-----	<b>Time fuze</b>
Дымовой	-----	<b>Smoke (adj)</b>
Зажигательный	-----	<b>Incendiary</b>
Зажигательный пристрелочный	-----	<b>Incendiary ranging</b>
Замедление	-----	<b>Delay</b>

## FOREIGN ORDNANCE TERMS

Russian - continued

Предохранитель	-----	<b>Safety</b>
Противопехотный	-----	<b>Antipersonnel</b>
Противотанковый	-----	<b>Antitank</b>
Ракета	-----	<b>Rocket</b>
Ракетный снаряд	-----	<b>Rocket projectile</b>
Снаряд	-----	<b>Projectile; shell</b>
Тетрил	-----	<b>Tetryl</b>
Тетритол	-----	<b>Tetrytol</b>
Тринитротолуол	-----	<b>Trinitrotoluene</b>
Тритонал	-----	<b>Tritonal</b>
Тротил	-----	<b>Trinitrotoluene; trotyl</b>
Трубка	-----	<b>Fuze; tube; pipe</b>
Ударный	-----	<b>Impact (adj)</b>
Усилитель детонатора	-----	<b>Booster</b>
Фосфор	-----	<b>Phosphorus</b>
Фугасный	-----	<b>High explosive</b>
Химический	-----	<b>Chemical; gas</b>
Циклонит	-----	<b>Cyclonite</b>
Чувствительный	-----	<b>Sensitive</b>

## FOREIGN ORDNANCE TERMS

Russian - continued

Запальник	-----	<b>Igniter</b>
Кумулятивный бронепрожигающий	-----	<b>High-explosive antitank</b>
Кумулятивный заряд	-----	<b>Shaped charge</b>
Кумулятивный снаряд	-----	<b>Shaped-charge projectile</b>
Марка	-----	<b>Mark; stamp; model</b>
Мгновенный	-----	<b>Instantaneous</b>
Мина	-----	<b>Mortar projectile; mine</b>
Миномет	-----	<b>Mortar</b>
Наконечник	-----	<b>Cap</b>
Незаряженный	-----	<b>Inert; empty</b>
Неконтактный взрыватель	-----	<b>Proximity fuze</b>
Окончательно снаряженный (ок. сн., ок. снар.)	-----	<b>Fuzed</b>
Опасно ВВ	-----	<b>Danger! Explosives</b>
Осветительный	-----	<b>Illuminating</b>
Осветительный снаряд	-----	<b>Flare; illuminating shell; star shell</b>
Осколочный (оск., оско.)	-----	<b>Fragmentation; antipersonnel</b>
Подрывной	-----	<b>Demolition</b>

## FOREIGN ORDNANCE TERMS

---

### Arabic

0	-----	٠
1	-----	١
2	-----	٢ / ٢
3	-----	٣ / ٣
4	-----	٤
5	-----	٥
6	-----	٦
7	-----	٧
8	-----	٨
9	-----	٩
10	-----	١٠
11	-----	١١
20	-----	٢٠



## FOREIGN ORDNANCE TERMS

Arabic - continued

<b>antiaircraft</b> -----	مضاد للطائرات (م/مخ)
<b>antipersonnel</b> -----	مضاد للأشخاص (م/أ)
<b>antitank</b> -----	مضاد للدبابات (م/د)
<b>armor-piercing</b> -----	ثاقب المدرع (ث/م) • ثاقب (ث)
<b>bomb (aircraft)</b> -----	قنبلة (قن)
<b>bomb (mortar)</b> -----	بمبة
<b>delay</b> -----	تعويق
<b>electrical</b> -----	كهربائية • كهربائي
<b>explosive</b> -----	أنفجار

## FOREIGN ORDNANCE TERMS

Arabic - continued

<b>fuze</b> -----	. طاية . صمامة
<b>base fuze</b> -----	. صمامة القاعدة
<b>fuze cap</b> -----	. غطاء الصمامة
<b>delay fuze</b> -----	. صمامة تعويق
<b>electrical fuze</b> -----	. صمامة كهربائية
<b>base fuze</b> -----	. صمامة مصادمة
<b>instantaneous fuze</b> -----	. صمامة فورية . طاية لحظية
<b>mechanical-time fuze</b> -----	. صمامة آلية زمنية
<b>point fuze</b> -----	. صمامة الرأس
<b>quick fuze</b> -----	. صمامة سريعة
<b>safety fuze</b> -----	. طاية الامن
<b>time fuze</b> -----	. طاية زمنية

## FOREIGN ORDNANCE TERMS

Arabic - continued

grenade	قنبلة
handgrenade	قنبلة يدوية
high explosive	شديد الانفجار (ش/ف). متفجرة
illumination	مضية
impact	مصادمة
incendiary	حارق
inert	خامد
instantaneous	لحظية
mine	لغم
model	نموذج • طراز
mortar	هاون (ها)

## FOREIGN ORDNANCE TERMS

Arabic - continued

<b>projectile</b> -----	مقذوف ، قذيفة .
<b>illumination projectile</b> -----	مقذوف مضية .
<b>AP projectile</b> -----	مقذوف ثاقب المدرع .
<b>concrete-piercing</b> -----	مقذوف ثاقب خرسانة .
<b>HE projectile</b> -----	مقذوف شديد الانفجار .
<b>HEAT projectile</b> -----	مقذوف ذات حسونة جوفاء قذيفة هجومية
<b>incendiary projectile</b> -----	مقذوف حارق .
<b>practice projectile</b> -----	مقذوف تمرين .
<b>smoke projectile</b> -----	مقذوف دخان .
<b>tracer projectile</b> -----	مقذوف بكاشف .

## FOREIGN ORDNANCE TERMS

Arabic - continued

rocket	-----	. صاروخ
smoke	-----	. دخان
tracer	-----	. كاشق . خطاطة
type	-----	. طراز . نوع
year	-----	. عام . سنة

## FOREIGN ORDNANCE TERMS

### Chinese

一	-----	1
二	-----	2
三	-----	3
四	-----	4
五	-----	5
六	-----	6
七	-----	7
八	-----	8
九	-----	9
十	-----	10
十	-----	11
一百 or 百	-----	100
杀	-----	Antipersonnel

## FOREIGN ORDNANCE TERMS

Chinese - continued

杀爆变钢	-----	Antipersonnel HE fragmentation
彈底信管	-----	Base-detonating fuze
黑火药	-----	Black-powder
延	-----	Delayed Action (fire)
炸藥	-----	Explosive
輕放	-----	Fragile (no rough handling)
杀爆	-----	Fragmentation
信管	-----	Fuze
破壞藥	-----	High explosive
曳破	-----	High Explosive Antitank (HEAT)
碰炸信管	-----	Impact fuze
燒夷彈	-----	Incendiary shell
	-----	Black incendiary (thermite)

## FOREIGN ORDNANCE TERMS

Chinese - continued

瞬發信管	Instantaneous fuze
迫擊炮彈	Mortar shell
瞬	Nondelay
彈頭信管	Point-detonating fuze
彈頭 or 彈丸 or 炮彈	Projectile
火箭	Rocket
破	Shaped charge
短時延期信管	Short-delay fuze
煙藥彈	Smoke shell
定時信管	Time fuze
梯恩梯 / 茶褐火藥	TNT
式	Type



## MARKINGS

Below is a list of common alphanumeric markings that may be found on ordnance.

Alphanumeric Markings	Country
9M	USSR
AA	USSR
AK	NETHERLANDS
AMA	DENMARK
AMC	FRANCE
APX	FRANCE
ARF	ITALY
ARGES	AUSTRIA
ARS	FRANCE
AS	FRANCE
AS	USSR
ASS	FRANCE
AT	USSR
ATM	NORTH KOREA
AZDM	GERMANY (FEDERAL REPUBLIC POST WWII)
AZZ	GERMANY (FEDERAL REPUBLIC POST WWII)
BAE	UNITED KINGDOM
BCK	GERMANY (FEDERAL REPUBLIC POST WWII)
BCK	GERMANY (PRE WWII)
BK	USSR
BL	FRANCE
BMP	BELGIUM
BPD	ITALY
BR	SPAIN
BR	USSR
BRP	SPAIN
BT	FRANCE
C	CANADA

Alphanumeric Markings	Country
CAA	CHINA
CIS	SINGAPORE
CSA	CHINA
CSS	CHINA
CSSC	CHINA
DM	GERMANY (FEDERAL REPUBLIC POST WWII)
DM	GERMANY (FEDERAL REPUBLIC POST WWII)
DYNAMITE NOBEL	GERMANY (FEDERAL REPUBLIC POST WWII)
EAB	FRANCE
ECIA	SPAIN
ECN	FRANCE
ECP	FRANCE
EF	SINGAPORE
EHD	BELGIUM
EM	CHINA
ET	CHINA
ET	USSR
EURO	NETHERLANDS
EVR	CZECHOSLOVAKIA
F	CHILE
F	SWEDEN
F	USSR
FAB	USSR
FB	CHILE
FB	ITALY
FERRANTI	UNITED KINGDOM
FFR	SWEDEN
FFV	SWEDEN
FL	NETHERLANDS
FMK	ARGENTINA

## MARKINGS

Alphanumeric Markings	Country
<b>FN</b>	BELGIUM
<b>FROG</b>	USSR
<b>FrSv</b>	CZECHOSLOVAKIA
<b>FUI</b>	FRANCE
<b>GIAT</b>	FRANCE
<b>gts</b>	CZECHOSLOVAKIA
<b>H</b>	FRANCE
<b>HBS</b>	UNITED KINGDOM
<b>HGC</b>	IRAQ
<b>HGE</b>	IRAQ
<b>HE</b>	IRAQ
<b>HP</b>	AUSTRIA
<b>IMB</b>	UNITED KINGDOM
<b>IMI</b>	ISRAEL
<b>JNS</b>	NETHERLANDS
<b>KAAKAA</b>	EGYPT
<b>KB</b>	YUGOSLAVIA
<b>KV/YU</b>	YUGOSLAVIA
<b>KY/KU</b>	YUGOSLAVIA
<b>L</b>	UNITED KINGDOM
<b>LOS</b>	GERMANY (FEDERAL REPUBLIC POST WWII)
<b>LU</b>	FRANCE
<b>LUL</b>	FRANCE
<b>M</b>	BELGIUM
<b>M</b>	CHILE
<b>M</b>	ISRAEL
<b>M</b>	ITALY
<b>M</b>	SOUTH AFRICA
<b>M</b>	SPAIN
<b>M</b>	SWEDEN
<b>M</b>	SWEDEN

Alphanumeric Markings	Country
<b>M</b>	SWEDEN
<b>M</b>	SWEDEN
<b>M</b>	YUGOSLAVIA
<b>M.Md1</b>	FRANCE
<b>MA</b>	BELGIUM
<b>MA</b>	NETHERLANDS
<b>MAUSER</b>	GERMANY (FEDERAL REPUBLIC POST WWII)
<b>MCR</b>	BELGIUM
<b>MDH</b>	VIETNAM
<b>MK</b>	FRANCE
<b>MK</b>	ISRAEL
<b>MK</b>	ITALY
<b>MK</b>	PAKISTAN
<b>MK</b>	SWEDEN
<b>MK</b>	UNITED KINGDOM
<b>MKE</b>	TURKEY
<b>MKS</b>	ISRAEL
<b>MKS</b>	UNITED KINGDOM
<b>MLE</b>	FRANCE
<b>MN</b>	ITALY
<b>MOD</b>	TURKEY
<b>MODEL</b>	AUSTRIA
<b>MODEL</b>	BELGIUM
<b>MODEL</b>	EGYPT
<b>MODEL</b>	FRANCE
<b>MODEL</b>	FRANCE
<b>MODEL</b>	GERMANY (FEDERAL REPUBLIC POST WWII)
<b>MODEL</b>	ITALY
<b>MODEL</b>	SPAIN
<b>MODEL</b>	SWEDEN
<b>MODEL</b>	SWITZERLAND

## MARKINGS

Alphanumeric Markings	Country
MP	CHINA
MPA	BELGIUM
MR	FRANCE
MVA	SWEDEN
MZ	CZECHOSLOVAKIA
NASR	EGYPT
NICO	GERMANY (FEDERAL REPUBLIC POST WWII)
NICO	GERMANY (PRE WWII)
NO.	AUSTRIA
NO.	ISRAEL
NO.	UNITED KINGDOM
NR	BELGIUM
NR	NETHERLANDS
NWN	NETHERLANDS
NZ	CZECHOSLOVAKIA
O	USSR
OF	CZECHOSLOVAKIA
OF	USSR
OZM	USSR
OZT	CZECHOSLOVAKIA
P	ITALY
P	PAKISTAN
PBR	BELGIUM
PDB	SPAIN
PDM	BULGARIA
PDM	USSR
PI	GERMANY (FEDERAL REPUBLIC POST WWII)
PI	GERMANY (PRE WWII)
P-ISV	CZECHOSLOVAKIA
PL	CHINA
PMA	CZECHOSLOVAKIA

Alphanumeric Markings	Country
PMA	YUGOSLAVIA
PMP	GERMANY (PEOPLES REPUBLIC POST WWII)
PO	SPAIN
POM	YUGOSLAVIA
PP	CZECHOSLOVAKIA
PPD	NORWAY
PP-MI	CZECHOSLOVAKIA
PRB	BELGIUM
PRB	NETHERLANDS
PROM	YUGOSLAVIA
PS	SOUTH KOREA
PSM	BULGARIA
PSV	CZECHOSLOVAKIA
PT	CZECHOSLOVAKIA
PT-MI	CZECHOSLOVAKIA
R77	PHILIPPINES
RBK	USSR
RBS	SWEDEN
RHEIMENTALL	GERMANY (FEDERAL REPUBLIC POST WWII)
RKV	SWITZERLAND
RKVDIR	SWITZERLAND
RMS	FRANCE
RO	CZECHOSLOVAKIA
RTE	FRANCE
RYN	FRANCE
S	ITALY
S	SINGAPORE
S	USSR
SA	USSR
SAE	FRANCE
SC	FRANCE

## MARKINGS

Alphanumeric Markings	Country
<b>SET</b>	USSR
<b>SM</b>	FRANCE
<b>SNILA</b>	ITALY
<b>SOL</b>	ISRAEL
<b>SPRA</b>	UNITED KINGDOM
<b>SS</b>	FRANCE
<b>SS</b>	USSR
<b>TAAS</b>	ISRAEL
<b>TAM</b>	FINLAND
<b>TECTEL</b>	SOUTH AFRICA
<b>TMA</b>	CZECHOSLOVAKIA
<b>TMA</b>	YUGOSLAVIA
<b>TYPE</b>	CHINA
<b>TYPE</b>	DENMARK
<b>TYPE</b>	FRANCE
<b>TYPE</b>	GERMANY (FEDERAL REPUBLIC POST WWII)

Alphanumeric Markings	Country
<b>TYPE</b>	GERMANY (PRE WWII)
<b>TYPE</b>	JAPAN
<b>UMR</b>	YUGOSLAVIA
<b>UPM</b>	YUGOSLAVIA
<b>UT</b>	YUGOSLAVIA
<b>UTI</b>	YUGOSLAVIA
<b>UTM</b>	YUGOSLAVIA
<b>UTU</b>	YUGOSLAVIA
<b>V</b>	FRANCE
<b>V</b>	USSR
<b>VS</b>	ITALY
<b>W</b>	SPAIN
<b>WALLOP</b>	UNITED KINGDOM
<b>YAM</b>	USSR
<b>ZAB</b>	USSR

# MARKINGS

Below are common graphic symbols and markings found on ordnance.

Italy

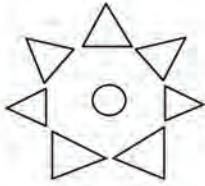

Denmark



Bulgaria



Belgium



China

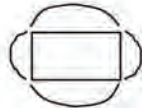

USSR



France





## SAFETY AND GENERAL INFORMATION

---

### BOMB

---

#### INTRODUCTION:

- Positively identify the bomb.
- HE-filled bombs may have rocket motors or fillers such as chemical agents, photoflash composition, or incendiary material.
- Observe safety precautions for the applicable fuze(s) during fin removal.
- Presuppose the most dangerous fuze(s) installed if visual recognition cannot be performed.
- Protective works should be considered before demolition.
- Tail sections may break away during impact altering appearance.
- Nose fuzes may be unidentifiable after impact.
- Tail sections may conceal a fuze, be badly damaged, or unremovable.

#### SAFETY:

- Do not move/jar except by remote means; fuzes may contain a hung cocked striker, antidisturbance device, etc.
- Do not move/jar a bomb until determination of fuzing type.
- Do not drop/jar a fuze; the fuze may start or resume functioning, or may release a hung cocked striker.
- Do not turn arming vanes, insert safety pins or pop-out pins, pull or cut arming lanyards, or attempt fuze removal.
- Tail sections may incorporate hazardous components such as ejection charges and powerful springs.
- Recognition of anti-disturbance, electronic multifunction, and long-delay fuzes is a priority.
- Do not use fuze-related accessories, such as lanyard lock, lanyard adjusters, closure ring/closure plug as positive identification features.

#### SAFETY CONSIDERATIONS

#### HIGH EXPLOSIVE/FRAGMENTATION:

- Observe magnetic, seismic, and acoustic precautions during the approach and continue to observe until it is ascertained that the precautions are not present.
- Do not remove fuzes by hand on picric acid filled bombs, fuze removal could detonate the bomb if salts are present.
- Do not pack a fuze well with plastic explosive if the well contains a detonator. Detonators are sensitive to heat, shock, and friction.
- Do not attempt to separate the detonator from the pistol, if attached, after pistol is removed from bomb. The firing pin may be embedded in the detonator, or explosive salts may have formed between the detonator and the pistol.
- Do not remove a United Kingdom tail pistol by hand if it has been in the bomb in excess of 14 days. Removal may function the detonator if explosive salts have formed between the detonator and the pistol.
- Thermal coating will attenuate the power of demolition charges.

## SAFETY AND GENERAL INFORMATION

---

### BOMB - continued

---

#### SAFETY CONSIDERATIONS - continued

##### CHEMICAL:

- Large carrier bombs may contain linear cutting charges/central bursters.
- Most are thin-walled and therefore liable to rupture leaking contents.
- Personnel Protective Clothing and breathing apparatus may be required.
- Identification of fill is vital before any action.
- Leak sealing and packaging may be necessary.
- Downwind hazard areas should be calculated.

##### PYROTECHNIC:

- Photoflash bombs must be handled with the same care as black powder, and with even greater care than conventional explosive-loaded bombs. When loose photoflash powder is observed, stop all work until the loose powder has been desensitized and the leaking bomb has been removed from the operating area.
- Do not manually remove a fuze from a photoflash bomb. The bomb burster charge or photoflash powder may be in the fuze threads, and may detonate the bomb if pinched in the threads.
- Non-stabilized incendiary bombs may use all-way acting fuzes.



## SAFETY AND GENERAL INFORMATION

---

### DISPENSER

---

#### INTRODUCTION:

- Observe all safety precautions applicable to the fuze.
- Observe all safety precautions applicable to the payload.
- Positively identify the dispenser and payload. It may contain random delay fuzing and a payload of HE, incendiary, chemical, or smoke munitions.

#### SAFETY CONSIDERATIONS

- Approach a dispenser from an upwind direction until certain that no chemical or other toxic agent is present.
- Approach and work from the side of a dispenser only. Should an actuation occur, payload items may be ejected with dangerous force.
- Consider a dispenser loaded. The presence or absence of a payload may not be obvious from an external examination.
- Exercise caution around a dispenser or cluster adapter that contains no payload. The dispenser may contain explosive detents, ejection cartridges, or other explosive devices.
- Remain clear of retracted dispenser fins; actuation may cause injury.
- Do not jar or unnecessarily move the fuze or dispenser. Such action may initiate the dispenser and eject its contents.
- Do not remove munitions from a dispenser unless absolutely necessary. Many of the contained munitions are designed to arm as soon as they leave the dispenser.
- Render safe any separated contents before performing the procedures on the cluster adapter. Bombs outside the adapter/ dislodged within it may be armed.
- If multi-fuzed, evaluate all conditions and render safe the most dangerous fuze first.

## SAFETY AND GENERAL INFORMATION

---

### PROJECTILE

---

#### INTRODUCTION:

- Projectiles include guns, mortars, howitzers, and recoilless rifles other than small arms and may be rocket assisted.
- Carry any type of payload, including high explosive, chemical, incendiary, pyrotechnic, biological, inert, training, and spotting payloads.
- Sizes from less than 20 millimeters to over 16.00 inches in diameter.
- Vary widely in fuze functioning and operating principles.
- May have multi-fuzing in a single projectile.

#### SAFETY CONSIDERATIONS:

- Consider armed if fired.
- Determine the condition of the fuze or fuzes before moving.
- Ascertain type and amount of projectile main charge or filler and the number and types of any other explosive or pyrotechnic components which may be present.
- Physical characteristics and engraved/stamped.
- Determine the country of origin of the projectile and compare its color marking against known national markings and color codes, if possible.
- Examine a projectile for the presence or absence of an unfired tracer.
- Stay clear of front and rear of ejection projectile.
- Do not pick up a fired projectile.
- Observe rocket motor precautions with a rocket-assisted projectile.
- Do not dismantle, disassemble, or strip unexploded projectiles.
- Personnel Protective Equipment (PPE) available when handling smoke and/or riot-control agents
- Do not approach a smoking WP/PWP projectile unless absolutely necessary.
- Assume a practice projectile contains a live charge until determined.
- Some cartridges contain powdered metals, which may react violently and liberate explosive or toxic fumes when exposed to moisture.
- Extreme caution when handling explosive-loaded components which have been separated from the projectile.

## SAFETY AND GENERAL INFORMATION

---

### PROJECTILE - continued

---

#### FUZES:

- Exercise extreme care in handling graze-sensitive, electric, switch-actuated, piezoelectric, spring-loaded, and cocked-striker fuzes.
- Wait 1 hour before approaching a possible armed VT fuze to permit the electrical charge to bleed off.
- Do not attempt to remove base fuzes from projectiles unless remote stripping facilities are available.
- Extreme care in handling air column fuzes; Many are always armed.
- Do not disturb or remove any foreign matter embedded in an armed fuze.
- Do not attempt to replace safety pins/wires, or to reset.
- Seal the open end of the flash tube with tape/suitable material.
- Protect the primer when handling or transporting ammunition/propellant case.
- Observe EMR precautions on fuzes with stored electric energy or electric-producing crystals (piezo).

## SAFETY AND GENERAL INFORMATION

---

### GRENADE

---

#### INTRODUCTION:

- Hand or rifle projected.
- Main charge includes HE, riot-control agents, smokes, and incendiary and pyrotechnic materials.
- Fuzing is varied and may be time-delay or impact fuzed.
- Are easily and frequently boobytrapped.
- Practice grenades are usually externally identical to the grenades they simulate

#### SAFETY:

- Do not drop or jar.
- Do not disturb, except remotely, until fuze condition can be determined.
- Do not handle unless safety pin and fly-off lever in place and secured.
- Wait at least 30 minutes before approaching a suspected dud-fired grenade, deterioration/dampness may prolong the burning time of the delay.
- Do not attempt to remove the fuze from a dud-fired grenade.
- Do not attempt to replace the safety pin in a dud-fired grenade.
- Manually handle an armed grenade as a last resort and after considering all methods of remote disposal.
- Wear protective equipment with known/suspected chemical grenades.
- Do not approach a smoking WP grenade unless absolutely necessary.
- Move an embedded grenade remotely, it may contain a piezoelectric fuzing system.
- Do not dispose by functioning normally, may be boobytrapped.
- Observe cover and safe distances before disposal. Fragments may be projected over a radius of 650 feet (198 meters).

#### SAFETY CONSIDERATIONS

#### ANTI-ARMOR/HEAT:

- Armed or damaged anti-armor/heat grenades should not be touched.
- Stab-sensitive detonator assembly contains a substantial booster charge.
- Ensure shaped charge cone is crushed during disposal.
- Ensure presence of fuze-cover securing stable prior to removing handle.

## SAFETY AND GENERAL INFORMATION

---

### GRENADE - continued

---

#### SAFETY CONSIDERATIONS - continued

##### FRAGMENTATION:

- Fly-off lever partially released – dangerous condition.
- Percussion cap not struck sufficiently hard.
- Pyrotechnic fuse not ignited or fails to burn completely to detonator.
- Fuze loosens or unscrews on contact – separating detonator and main charge.
- Fragmentation grenades may be single thickness of steel deeply serrated or double thickness with inner-notched fragmentation coil.

##### IMPACT FRAGMENTATION:

- In addition to conventional design, have added all-way acting fuze
- Armed all-way acting fuzes may be sensitive to movement
- Mechanical fuze may be fully armed and functional even when delay detonator has failed.

##### RIFLE:

- Nose fuzes on fired unexploded rifle grenades are likely to be damaged.
- Observe shaped charge precautions until positive identification.
- Often difficult to identify warhead type, e.g., HEAT warheads may not have their normal characteristic profile.
- Fuze mechanisms vary widely and not readily identifiable unless marked.

##### CHEMICAL/SMOKE:

- Smoke grenades are usually made of thin sheet metal
- Riot-control grenades have emission holes covered with tape, spherical plastic, or synthetic rubber case.
- Incendiary grenades are usually sheet metal.

##### SPIN-STABILIZED (CANISTER/CARTRIDGE TYPE LAUNCHED):

- During demolition, ensure unfired grenades are not launched.
- Impacted fuzes may make unexploded grenades sensitive to shock.
- Despite size, these can be lethal at significant distances.
- Observe shaped charge precautions unless positively identified.

## SAFETY AND GENERAL INFORMATION

---

### FUZE

---

#### INTRODUCTION:

- Fuzes contain, in a single unit, an explosive initiating charge and the means for initiating this charge. Fuzing systems divide these elements and functions among several units.
- Certain elements of fuzing systems closely resemble fuzes and should be treated similarly to fuzes. Safety and arming (S&A) devices containing explosives, electrical circuits, and arming systems are typical of these.
- Fuzes and fuzing systems are used in a wide variety of surface ordnance, including bombs, dispensers, clusters, launchers, projectiles, grenades, rockets, landmines, guided missiles, pyrotechnic devices, and in some types of underwater ordnance.
- Fuzes and fuzing systems may be mechanical, pyrotechnic, chemical, electrical, electronic, or combinations of these. They function in a variety of designed modes such as impact, long delay, time after launch, and antidisturbance.

#### SAFETY CONSIDERATIONS:

- When identification of a fuze is impossible, the type of arming device and type of firing device in the fuze must be determined.
- When a fuze can be identified only as one of several types, treat the fuze as the most hazardous type.
- Do not drop, strike, or jar an armed fuze. It may be in a very sensitive condition and may be fired by such action.
- Avoid any unnecessary movement of an armed fuze.
- The fuze is considered the most hazardous component of explosive ordnance, regardless of type or condition.
- Observe magnetic, seismic, infrared, and acoustic precautions when approaching an unidentified fuze.
- Do not allow movement of equipment in the area until it is determined to be safe to do so. Some fuzes are designed to function on passage of a predetermined number of targets.
- Some fuzes contain boobytraps that function on fuze removal.
- Do not attempt to reset an adjustable clockwork fuze to an indicated safe position or reinsert any fuze safety device.
- Assume that an electric fuze is sensitive to shock, heat, discharges of static electricity, and stray electric current.
- Turn off any source of radio-frequency energy in the vicinity of a known or suspected proximity (VT) fuze. A proximity fuze may be capable of being fired by radio-frequency energy transmitted to the fuze by an outside transmitter.
- If the munition is known to contain a VT fuze, do not approach it until the prescribed waiting time has expired.
- Do not drop, jar, or strike a fuze, or subject it to heat or any other force likely to fire a possibly armed fuze. Many fuzes are fired by spring-loaded firing pins. In addition, the firing pin or other metal fuze part may be embedded in an explosive component.
- Keep a fuze which has been removed from ordnance separated from other explosive ordnance. A fuze located near another explosive charge may induce its detonation should the fuze accidentally explode.
- When transporting any fuze, position the fuze in the most neutral orientation possible, considering its design and all forces which may act on it or its components.

## SAFETY AND GENERAL INFORMATION

---

### ROCKET

---

#### INTRODUCTION:

- Rockets may be launched from aircraft, ships, vehicles, fixed positions, and by individuals.
- May contain a HE main charge or a variety of fillers including chemicals, submunitions, pyrotechnics, incendiaries, or combinations of these agents.
- The hazards include the warhead section and the propulsion system.

#### SAFETY CONSIDERATIONS:

- Approach/work from the side. Ignition will create a missile hazard/hot exhaust.
- Do not jar or disturb an armed warhead. If necessary to move, do remotely.
- Perform initial movement of an embedded rocket remotely.
- Positively ID, or assume most hazardous type fuze.
- Work most hazardous fuze first.
- Wait a sufficient time (at least 1 hour) for charged capacitors to discharge.
- Protect rockets within in an EMR field/environment.
- Do not dismantle, disassemble, or strip unexploded rockets or components.
- Wear Personnel Protective Equipment (PPE) for suspected chemical agents.
- Do not approach a smoking WP warhead unless absolutely necessary
- Wash thoroughly (soap and water) after handling rocket motor propellant.
- Do not expose electrically fired rocket motors within 25.0 feet (7.6 meters) of any exposed electronic transmitting equipment or exposed antenna leads.
- Do not transport an unfired rocket unless the motor igniter is shielded from EMR.

## SAFETY AND GENERAL INFORMATION

---

### GUIDED MISSILE

---

#### INTRODUCTION:

- Launched from aircraft, ships, vehicles, and by individuals.
- Size from large, fixed/mobile weapon to being carried/fired by one person.
- Warhead may contain HE, chemical, or biological agents.
- Propulsion may be solid propellant or liquid fuels and oxidizers.
- May be multi-fuzed and incorporate a self-destruct system.
- Most proximity fuzes have some type of impact backup.
- Location of explosive components should be verified before demolition
- Ensure venturi is destroyed during demolition to prevent flight.
- Unburned propellant may be capable of detonation under some circumstances.
- Unconventional fuzes may not be recognizable.
- The possible presence of tandem warheads must be considered.

#### SAFETY CONSIDERATIONS

##### APPROACH:

- Restrict all vehicle movement in the vicinity of the missile.
- Avoid entanglement with the wires of a wire-guided missile.
- Terminate radio transmissions as per safe distance recommendations of service directives.
- Approach an unidentified guided missile from the side. Many missiles have proximity fuzes, IR fuzes, and some produce microwave radiation.
- Do not approach a guided missile that has been in a fire until sufficient time has elapsed for it to cool. If the missile has a specified waiting period, the period should commence after the missile has cooled.
- When approaching an unidentified guided missile, observe chemical and fuel precautions until monitoring has verified that the missile does not contain a chemical warhead or a leaking motor.
- Approach/work on an unfired rocket motor from the side.
- Do not approach an armed guided missile that has proximity fuzing while using a fluorescent light. Fluorescent light has been known to function armed proximity fuzes.
- Impact fuzes may be located on the leading edge of fins.



## SAFETY AND GENERAL INFORMATION

---

### GUIDED MISSILE - continued

---

#### SAFETY CONSIDERATIONS - continued

##### IDENTIFICATION:

- Remotely perform initial movement necessary for missile identification.
- An air-to-air or surface-to-air missile generally contains an HE-fragmentation warhead.
- A surface-to-surface or air-to-surface missile may contain any type of warhead.
- Single-piece rocket motor probably contains solid propellant, while a two/ or three-piece construction may be an engine containing liquid propellant.
- Some liquid-propellant engines may have a solid-propellant grain (gas generator) for combining the fuel and oxidizer.
- If possible, wait for a period after impact before approaching an unknown missile. (Wait requirements vary widely; observe a minimum of 3 hours, if possible.) This period may allow the missile to self-destruct, shut off, or exhaust its firing power.

##### FUZING SYSTEMS:

- Consider the warhead armed if the missile's has been fired.
- Do not strike or jar any missile components.
- Some also contain an anti-breakup device along the length of the warhead.
- Do not disconnect or cut any electrical cable. A fuzing and firing circuit can fire because of a loss of or drop in voltage.

##### PROPULSION SYSTEMS:

- Wear protective clothing/respiratory equipment when working on a liquid-propellant rocket engine.
- Observe maximum fire-prevention precautions for the rocket motor.
- Remain upwind when missile is suspected of leaking fuels and oxidizers.
- Do not allow fuels to mix with oxidizers. Mixture of the two liquids will result in a violent hypergolic reaction.
- Thoroughly wash the outer surface of protective clothing after working in the presence of fuels and/or oxidizers.
- Do not attempt to remove an igniter from a missile motor section.
- Guidance and control systems.
- Protect against burns and toxic dust/gases from a thermal battery.
- Avoid body contact with the highly corrosive electrolyte used in wet-cell batteries.
- Do not move, bend, cut, or disconnect any high-pressure lines until certain that the system is void of pressure. Remotely cut or separate any line suspected of being under pressure. Almost all guidance and control systems contain high-pressure air, hydraulic liquid under pressure, or both.

## SAFETY AND GENERAL INFORMATION

---

### LANDMINE

---

#### INTRODUCTION:

- Landmines are emplaced area-denial weapons, from small antipersonnel (apers) types to larger antitank (AT) or special-purpose types (off-route).
- Landmines may be designed to be boobytrapped with anti-lift devices.
- Landmines may be loaded with high explosives, chemicals, or pyrotechnic materials.
- Fuzed in a variety of ways, including mechanical, electrical, chemical, acoustic/seismic, infrared, magnetic-influence, or controlled firing systems. They may be fired by pressure, tripwire, tension release, explosive pressure pulse, pressure release, magnetic field changes, or direct electrical circuit closure.

#### SAFETY:

- Observe magnetic precautions when approaching/working with a known or suspected magnetic influence fuze.
- If it is absolutely necessary to walk into a mined area, move slowly, looking at the ground carefully to note disturbances in the soil and the presence of any tripwires.
- Permit only one person at a time to work on one mine.
- Probe and examine the ground around a mine before starting to work on it.
- Take boobytrap precautions.
- Before lifting a mine, neutralize all external fuzes.
- Perform all initial movement of the mine remotely.
- Assume the presence of other mines nearby whenever a landmine is located.
- Before disarming, determine the number and types of fuzes within the mine to ensure proper safety precautions are followed.
- A nonmagnetic probe is safer to use, as the mine may have a magnetic fuze.
- AT mines may be protected by apers mines.
- Do not manually disturb, drop, or strike an armed mine or mine fuze. It may contain a cocked-striker firing system.
- Consider an emplaced landmine armed and remove remotely.
- Do not cut/pull a taut wire; never pull a slack one.
- Take cover before pulling a mine and wait for at least 60 seconds.
- Do not handle an AT mine that has been pulled from its emplacement until after closely examining the mine case to ensure that the case was not deliberately altered to permit separation at its base. Separation of the mine case from its base and main charge will function an internal pressure/pressure-release fuze.
- Do not use force on a mine or boobytrap. If a part cannot be removed without applying an undue amount of force, cease removal procedures and destroy the mine in place.

## SAFETY AND GENERAL INFORMATION

---

### LANDMINE - continued

---

#### SAFETY - continued

- If a mine or boobytrap must be left unlifted, mark the location prominently and notify the proper authorities.
- Improvised grapnels may be used to clear tripwire-actuated mines.
- When cutting the wires of an electric detonator, cut and tape them one at a time to avoid closing the circuit with the wire cutters. A mine is harmless if the firing train is broken, but there may be more than one firing train.
- Do not stack fuzed mines. Many types contain pressure-actuated fuzing which may be fired by such action.
- If possible, destroy in place all mines loaded with picric acid explosive. Extremely sensitive explosive salts may have formed wherever the explosive contacts the metal.
- Observe acoustic/seismic precautions when approaching or working on landmines with a known or suspected acoustic/seismic fuze.
- Do not remove a mine from its emplacement if the pressure plate is compressed or deformed. The fuze may contain a hung cocked firing pin.
- The preferred disposal procedure for antipersonnel and antitank landmines is to detonate or burn using incendiary grenades for the situation found.
- Do not permit personnel, vehicles, or any heat-generating source to pass in front of an infrared receiver.
- Some fuzes may not have a safety feature, or a safety device may not be available or cannot be applied.

#### SAFETY CONSIDERATIONS

##### ANTI-TANK (AT) MINES:

- Do not uncover until the ground has been thoroughly checked for anti-lift devices. Probe cautiously, for even nearby disturbance by the probe may release the fuze striker.
- Exercise care when disarming wooden AT mines by hand. Frequently, holes are drilled through the bottom of the case and pullwires connected to auxiliary fuzes are threaded and anchored to a stake underneath. If the stake is driven deep enough, it is not easy to locate the wire by probing. A pressure-release fuze or pull fuze with pullwire may be actuated by raising or removing the pressure plate or lid. Some wooden mines have a special mousetrap device that is actuated in this way.
- Exercise care with wooden AT mines that have been buried for a long time. Because of soil conditions, the wood deteriorates and the slightest inadvertent pressure on the top may initiate the fuze.

## SAFETY AND GENERAL INFORMATION

---

### LANDMINE - continued

---

#### SAFETY CONSIDERATIONS - continued

##### ANTIPERSONNEL:

- Be alert for small apers mines laid along the side of or underneath the tripwire to hinder disarming.
- Always trace the tripwire from the friendly side - do not straddle it - as a safeguard against accidental tripping or stepping on a small apers mine laid underneath the tripwire.

##### OFF-ROUTE:

- Electronic off-route mines may contain an anti-handling option.
- Contact with fuzing sensor or into field of view may initiate.
- Do not cut connected electric wires/breakwires – collapsing circuit.
- Precautions to prevent formation of HEAT jet or self-forging fragment.

##### FUZES:

- Be extremely cautious disarming tilt fuzes by hand, especially if they have been partially initiated. There must be no movement of the tilrod when the fuze is removed from the mine.

## SAFETY AND GENERAL INFORMATION

---

### NAVAL MINE

---

#### INTRODUCTION:

- Naval mine may be air-laid, submarine-laid, or surface-laid.
- Identification of a naval mine is inherent in the features of the mine case and fittings as influenced by the laying agent, and features inherent in its firing system.
- Most naval mines employ a case shape involving a sphere, some part of a sphere, a cylinder, or a combination of these
- Mine case identifying elements include the size and shape of the case, details of its external features, and any attached fittings or accessories.
- Painting and markings, as well as the type of material of the case and components, are valuable data if they can be readily determined without disturbing the mine.

#### SAFETY:

- Observe influence precautions when approaching all unidentified mines until the firing means is identified, then observe the appropriate precautions.
- Do not touch an unidentified mine with any metallic object.
- Do not assume all mine in a minefield are of the same type or setting.
- Do not approach a mine in the surf. Wait until the tide drops or surf subsides.
- Attempt to locate and stay clear of flooders.
- Assume the mine contains the most hazardous component combination for which it is designed.
- Do not disturb or move an armed mine except by remote means from a safe distance.
- Assume all mines contain a self-destruct capability.
- Use nonmagnetic tools and equipment to gain access to an unknown mine buried no land.
- Assume an unknown mine is fitted with antirecovery devices.
- Consider all mines adrift on the surface to be armed and functional.

## SAFETY AND GENERAL INFORMATION

---

### NAVAL MINE - continued

---

#### CONSIDERATIONS

##### CONTACT MINES:

- Chemical horn, cocked striker and sea water battery firing systems have an indefinite firing life.
- Chemical horn mine may remain functional even if the case is flooded.
- Avoid all lines and cables attached to the mine as they may be snag lines or function as galvanic antennas.
- Move a beached/sunken mine remotely. Mine movement can function a chemical or switch horn or whisker, or actuate an inertial firing device.
- Do not move any protruding object on a mine until its function has been positively identified.
- Do not put tension on a baseplate mooring spindle.
- Do not tamper with switches on a baseplate.
- Do not lift or move a mine by the mooring cable or place a strain on the cable unless it is determined such action will not close an internal mooring switch.

##### INFLUENCE MINES:

- Approach bottom mines from the nose end within a 45 to 90 degree angle of either side of the nose.
- Consider all influence mines of recent development to use magnetometers as the magnetic sensor
- Maintain influence precautions until the mine is determined to be unarmed, neutralized, or rendered safe.
- Keep all craft, other than the diving platform, at least 600 feet from the mine.
- Do not chip or scrape marine growth or rust from an armed influence mine.

##### CONTROLLED MINES

- If possible, determine the mine control point and ensure the actuation means is safed.
- Consider the possibility that more than one mine may be controlled from a single point, and that a single mine may have more than one control point.

## SAFETY AND GENERAL INFORMATION

---

### DEPTH CHARGE, SOUND SIGNALS, MARKERS, & MISCELLANEOUS

---

#### INTRODUCTION:

- It must be assumed personnel are reasonably familiar with procedures and have experience in these areas.
- There is no safe procedure for disposal of ordnance, but merely a procedure that is considered least dangerous.
- An operation involving both diving and explosives must be based on all safety considerations.
- No “always correct” rule or set of rules apply.
- Assume ordnance is in an armed condition and ready to fire unless it is determined to be otherwise.

#### CONSIDERATIONS

##### DEPTH CHARGES AND DEPTH BOMBS:

- Allow at least one passage of high tide before diving on a depth charge (bomb). An increase in water depth may take the fuze past its firing pressure, resulting in detonation.
- Observe magnetic safety precautions until it is established the charge/bomb does not contain a magnetic-influence firing mechanism.
- DO NOT rely on retraction of the booster extender to safe a depth charge.

##### PYROTECHNIC MARKERS AND SIGNALS:

- Consider these types of markers/signals to be armed if they have been subjected to water.
- DO NOT look directly at a burning marker/signal.
- DO NOT crush or break crusted phosphorus residue that may be present on an expended marker/signal.
- DO NOT inhale gases produced by markers/signals.
- DO NOT allow either end of a marker/signal to come in line with personnel, as ejected elements are a missile hazard.
- Be aware when red phosphorus is burned, incomplete combustion may produce deposits of red and white phosphorus which may contaminate surrounding areas.

##### PRACTICE DEPTH CHARGES AND SIGNALS, UNDERWATER SOUND (SUS):

- DO NOT disassemble a practice depth charge or SUS. Explosive exudate may be in the threads.
- DO NOT depress or retract a detonator holder. Depressing will align the detonator with the firing pin and explosive train while retraction could cause detonation if the firing pin has been driven into the detonator.
- DO NOT subject an armed practice depth charge or SUS to rough treatment. It may contain a cocked striker.

## SAFETY AND GENERAL INFORMATION

---

### SCATTERABLE

---

#### INTRODUCTION:

- From the very small, simple, cheap devices to the large, highly complex and expensive 'smart' munitions.
- Delivered by missiles, rockets, projectiles, and mortars.
- Fillers include HE, pyrotechnics, illuminants, and chaff.
- Dispensed by nose ejection, rear ejection, or case rupture.
- Stabilization includes fins, a streamer, or parachute.
- Most incorporate a separate arming mechanism.
- Targets include personnel, equipment, machinery, and area-denial.
- Most function upon impact but some are victim-operated or contain delays.

#### SAFETY:

- May incorporate stab-sensitive or all-way acting fuze(2).
- All-way acting fuze mechanisms can behave like an anti-disturbance device.
- Large numbers at a contaminated site complicates a clearance operation.
- Often found above ground in vegetation or manmade structures.
- Dispensers contain hazardous components such as ejection charges and linear cutting charges.
- Presence is indicated by empty containers and packaging.
- Armed bomblets prone to failure if impact angle too great or fall broken by vegetation or soft ground.
- May fail to arm if drop height is insufficient.
- Presence of an unexploded scatterable may indicate others are present.

#### CONSIDERATIONS

##### CHUTE-STABILIZED:

- May not arm if release altitude too low.
- Impacted fuzes may be in a highly sensitive state.

##### DPICM:

- Subject to a high failure rate.
- If armed, munition is highly sensitive to pressure on the fuze.
- They often become tangled in vegetation and structures.



## SAFETY AND GENERAL INFORMATION

---

### SCATTERABLE - continued

---

#### FIN-STABILIZED (HEAT):

- May penetrate soft ground and be buried due to high sectional density.
- Impacted fuzes may be highly sensitive especially piezoelectric types.

#### FIN-STABILIZED (FRAGMENTATION):

- Thick-walled varieties can produce heavy fragments, lethal at substantial ranges.

#### SPIN-ARMED:

- Due to failure in the fully armed condition due to insufficient impact energy.
- Armed with all-way acting fuzes sensitive to movement.
- Despite external corrosion, fuze mechanisms and detonators may be fully operational after many years.

***This page intentionally left blank***





# Afghanistan

Ordnance Identification Guide

## U.S. MARKER, LOCATION, MARINE, MK 25 MOD 3

Ordnance used with:  
MK 72 MOD 0, BATTERY, WATER ACTIVATED  
MK 25 MARINE LOCATION MARKER SYS. (HH-3, SH-3...

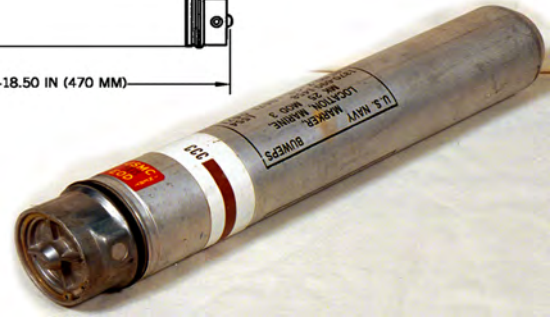
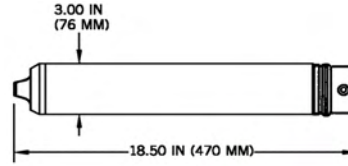

***THIS PAGE INTENTIONALLY LEFT BLANK***

**U.S.S.R. ACTUATOR MECHANISM ASSEMBLY,  
EXPLOSIVE, 549S / BR 549C / MN 549C, (USED WITH  
BFK-AO 2.5 CONTAINER ASSEMBLY)**

Ordnance used with:

KMGU

KMGU-2, DISPENSER, CAPTIVE

BKF AO-2.5 RT, SUBMUN. CTR UNIT, BOMB DISPENS...

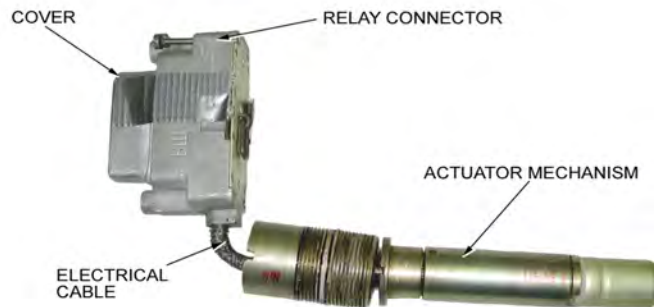

---

**U.S.S.R. AIRCRAFT FLARE, PK-3M-1**





**U.S.S.R. DEMOLITION CHARGE, SZ-3A**



**MARKINGS**



**U.S.S.R. EXPLOSIVE DISCONNECT/DEPLOYMENT MECHANISM, KP-527**

Ordnance used with:  
ZAB 500 SH, BOMB, INCENDIARY, 500 KG  
RBK-500 BETAB, DISPENSER, BETAB, 500 KG  
RBK-500 PTAB-1M, CBU  
AV-527, NOSE, ELEC.  
RBK-500 AO-2.5 RTM, CLUSTER BOMB  
RBK-500 AO-2.5 RT, CBU  
RBK-500 ZAB 2.50SM, CBU



**U.S.S.R. CARTRIDGE, PHOTOFLASH, FP-100M**

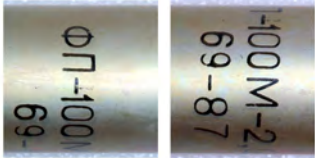

MARKINGS

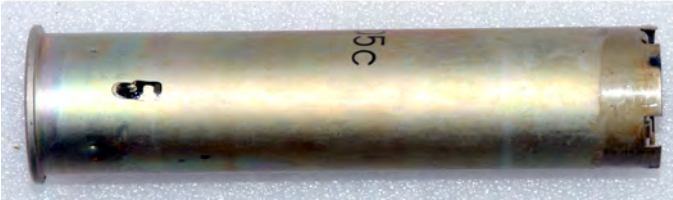

N.E.W. 533.00 G

**U.S.S.R. ROCKET EXPPELLING CHARGE, 57-MM, PG-16P**

Ordnance used with:  
PG-16, 58MM, HEAT-T  
PG-16V, 58MM, CARTRIDGE, HEAT

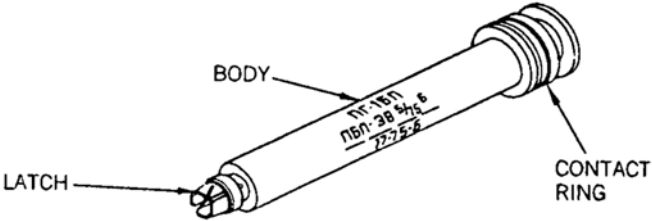

N.E.W. 281.00 G



**AFGHAN RECEIVER, FIRING DEVICE, RADIO CONTROLLED (RC), MODEL UNKNOWN**

Ordnance used with:  
MDL. UNKNOWN, KIT, FIRING DEV, RADIO CONTROLLED...  
MDL. UNKNOWN, TRANSMITTER, RADIO CONTROLLED (RC)

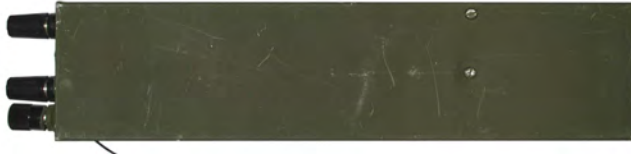

---

**AFGHAN TRANSMITTER, FIRING DEVICE, RADIO CONTROLLED (RC), MODEL UNKNOWN**



Ordnance used with:  
MDL. UNKNOWN, KIT, FIRING DEV, RADIO CONTROLLED...  
MDL. UNKNOWN, RECEIVER, RADIO CONTROLLED (RC)



**U.S.S.R. ROCKET MOTOR, NMF-2**

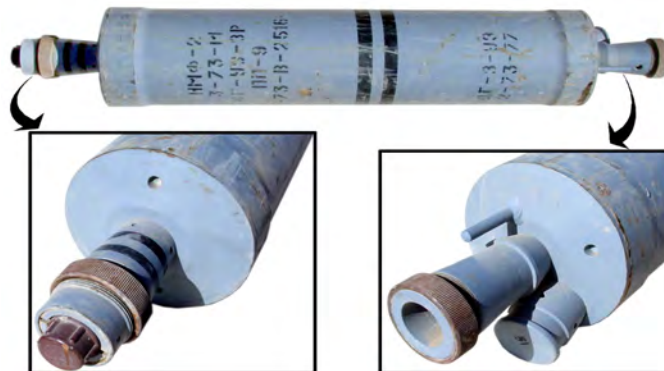

***THIS PAGE INTENTIONALLY LEFT BLANK***

**AFGHAN FIRING DEVICE, ELECTRONIC DELAY,  
MODEL UNKNOWN**



**TERRORIST/INSURGENT & GUERRILLA ORG FIRING  
DEVICE, IMPROVISED, RADIO CONTROLLED (R/C),  
MOVING COIL METER**



DIMENSIONS  
UNKNOWN

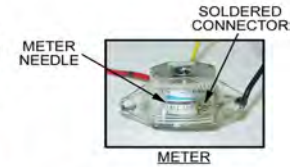

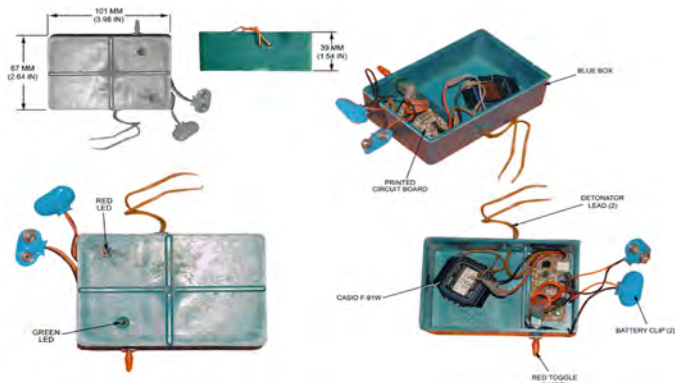

**AFGHAN FIRING DEVICE, ELECTRONIC TIMER, MODEL UNKNOWN**

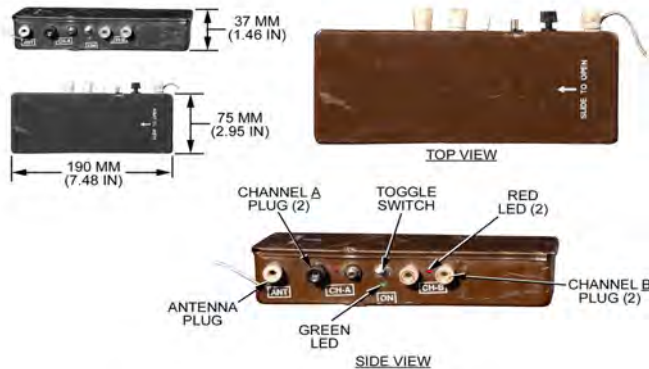

**TERRORIST/INSURGENT & GUERRILLA ORG IMPROVISED DEVICE, RADIO CONTROLLED (R/C), DTMF, BROWN BOX, MODEL UNKNOWN**

Ordnance used with:  
IMPROVISED EXPLOSIVE DEVICES, SUGGESTED EOD P...

## U.S.S.R. SMOKE POT, MODEL UNKNOWN



## GERMAN FLARE, AIRCRAFT, COUNTERMEASURES, INFRARED, DM 69

Ordnance used with:  
AN/ALE-40 (V), DISPENSER, COUNTERMEASURES, AI...  
MJU-12/A, MAGAZINE, AIRCRAFT, FLARE  
BBU-36, IMPULSE CARTRIDGE

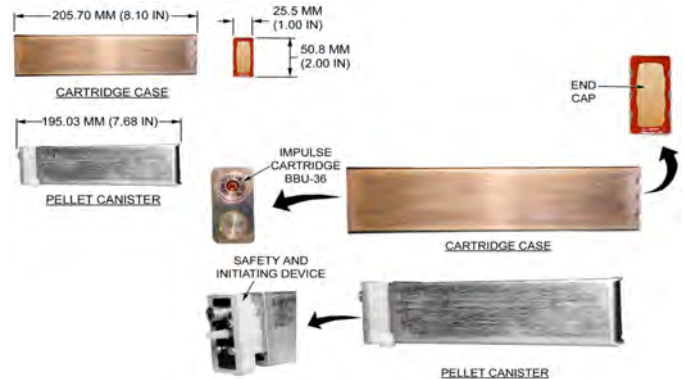

N.E.W. 6.40 OZ

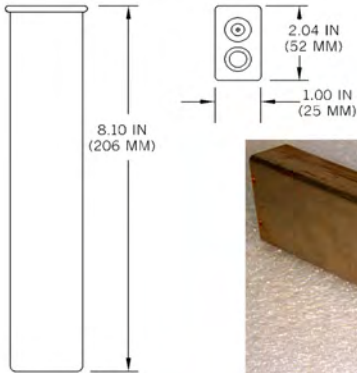

## U.S. CARTRIDGE, FLARE, INFRARED COUNTERMEASURES, MJU-7/B

Ordnance used with:

AN/ALE-40 (V), DISPENSER, CNTRMSRES, AIRCRAFT  
 AN/ALE-45, DISPENSER, COUNTERMEASURE, AIRCRAFT  
 AN/ALE-47, DISPENSER, COUNTERMEASURES, AIRCRAFT  
 MJU-12/A, MAGAZINE, AIRCRAFT, FLARE  
 MDL. UNDESIGNATED, PELLET, FLARE (MECHANICAL)  
 MDL. UNDESIGNATED, PELLET, SMOKE (PARASITIC)  
 AN/ALE-52, DISPENSER, COUNTERMEASURES, AIRCRA...

N.E.W. 1.00 G

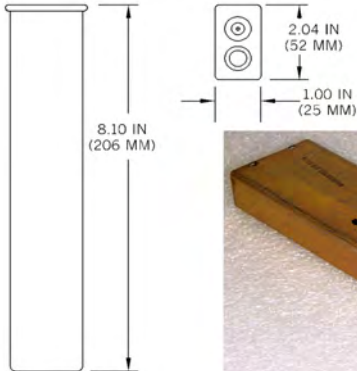

## U.S. CARTRIDGE, FLARE, INFRARED COUNTERMEASURES, MJU-7A/B

Ordnance used with:

AN/ALE-40 (V), DISPENSER, COUNTERMEASURES, AI...  
 AN/ALE-45, DISPENSER, COUNTERMEASURE, AIRCRAFT  
 AN/ALE-47, DISPENSER, COUNTERMEASURES, AIRCRAFT  
 MJU-12/A, MAGAZINE, AIRCRAFT, FLARE  
 MDL. UNDESIGNATED, PELLET, SMOKE (PARASITIC V...  
 AN/ALE-52, DISPENSER, COUNTERMEASURES, AIRCRA...  
 MULTI-PAYLOAD DISP. ASSEMBLY, FLARE/CHAFF(F/A...

N.E.W. 1.00 G



## U.S. CARTRIDGE, FLARE, M206

Ordnance used with:

AN/ALE-40 (V), DISPENSER, CNTRMSRES, AIRCRAFT  
AN/ALE-45, DISPENSER, COUNTERMEASURE, AIRCRAFT  
AN/ALE-47, DISPENSER, COUNTERMEASURES, AIRCRAFT  
M130, DISPENSER, AIRCRAFT, GENERAL PURPOSE  
XM130, DISPENSER, AIRCRAFT, GENERAL PURPOSE  
CH-53A, AIRCRAFT, HELICOPTER, (SEASTALLION)  
CH-53C, AIRCRAFT, HELICOPTER, (SEA STALLION)

N.E.W. 6.00 OZ

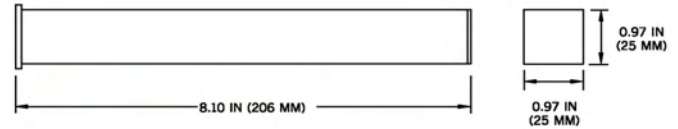

## U.S. CARTRIDGE, FLARE, MJU-50/B

Ordnance used with:

AN/ALE-40 (V), DISPENSER, CNTRMSRES, AIRCRAFT  
AN/ALE-47, DISPENSER, COUNTERMEASURES, AIRCRAFT  
MJU-11/A, MAGAZINE, AIRCRAFT, CHAFF/FLARE

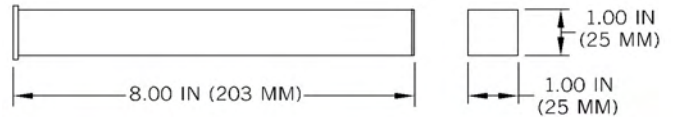

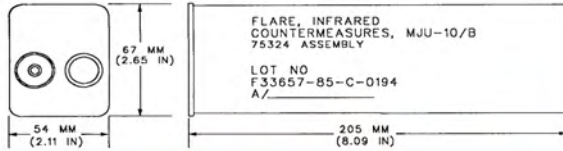

## U.S. CARTRIDGE, FLARE, COUNTERMEASURES, MJU-10/B

Ordnance used with:

- AN/ALE-40 (V), DISPENSER, CNTRMSRES, AIRCRAFT
- AN/ALE-45, DISPENSER, COUNTERMEASURE, AIRCRAFT
- C-5A, AIRCRAFT, CARGO (GALAXY)
- C-5B, AIRCRAFT, CARGO (GALAXY)
- F-15E, AIRCRAFT, FIGHTER (EAGLE)
- MJU-17/A, MAGAZINE, AIRCRAFT, FLARE
- MJU-41/A, MAGAZINE, FLARE, CNTRMSRES, AIRCRAFT

N.E.W. 2.00 LB

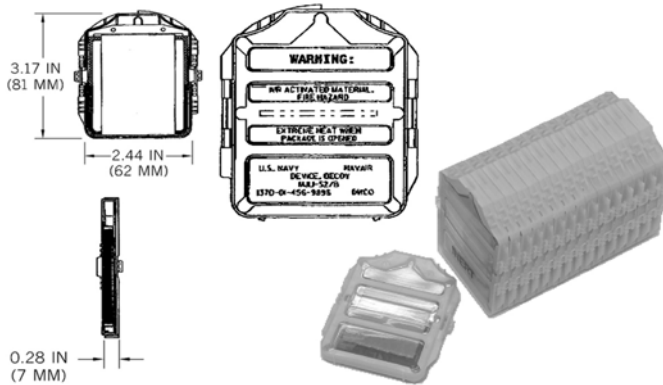

## U.S. FLARE DECOY, INFRARED, MJU-52/B (BOL-IR)

Ordnance used with:

- LAU-138A/A, DISPENSER, FLARE/CHAFF, CNTRMSR
- AN/ALE-58, DISPENSER, COUNTERMEASURE, AIRCRAF...
- BOL-515, DISPENSER, COUNTERMEASURES, AIRCRAFT...

N.E.W. 1.50 OZ

## U.S. CARTRIDGE, FLARE, INFRARED COUNTERMEASURES, MJU-23A/B

Ordnance used with:  
AN/ALE-49, DISPENSER, AIRCRAFT, FLARE (B-1B)

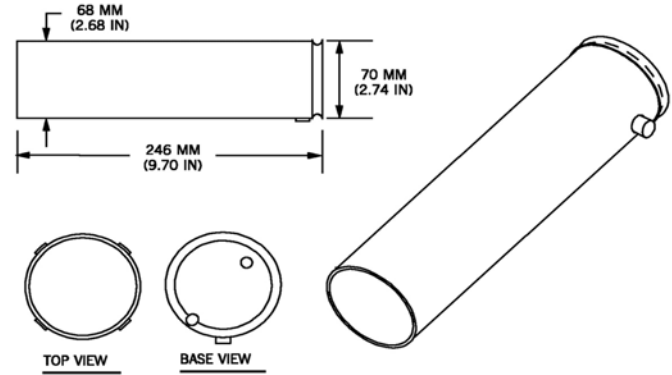

N.E.W. 3.10 LB

## U.S. FLARE SET, AN/ALA-17A

Ordnance used with:  
B-52D, AIRCRAFT, BOMBER, (STRATOFORTRESS)  
ALA-17B, FLARE, CARTRIDGE  
AN/ALE-20, DISPENSER, AIRCRAFT, FLARE  
ALA-17, FLARE, CARTRIDGE  
ALA-17A, FLARE, CARTRIDGE  
RR108/ALA-17, PELLET, FLARE

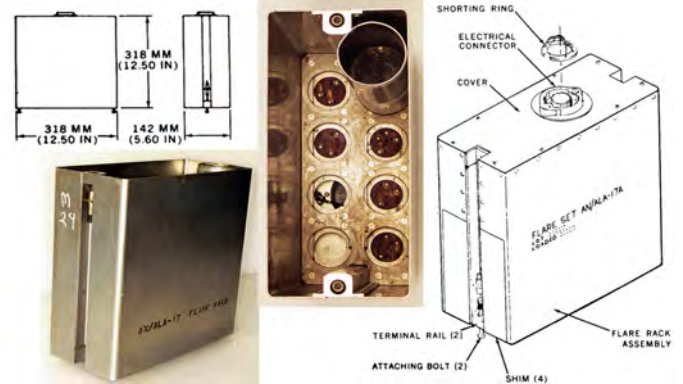

***THIS PAGE INTENTIONALLY LEFT BLANK***

## CANADIAN LANDMINE SYSTEM, 84MM, OFF ROUTE, C14

Ordnance used with:  
FFV 65 CARTRIDGE, 84-MM, HEAT-T



## CHINESE LANDMINE, APERS (BOUNDING), TYPE 69

Ordnance used with:  
MDL. UNKNOWN, LANDMINE, PULL/PRESSURE

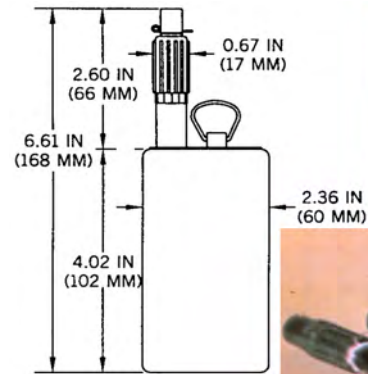

N.E.W. 110.00 G



**CHINESE LANDMINE, APERS, CLAYMORE, TYPE 66**



**PAKISTAN, P5 MK 1, APERS, CLAYMORE**



## PAKISTANI LANDMINE, APERS, P4 MK2



## U.S. LANDMINES: AT, HE, NONMETALLIC, M19; INERT, M19; AND TRAINING, M80

Ordnance used with:  
M/88, MAGNETIC INFLUENCE, LANDMINE  
M606, LANDMINE PRESSURE, AT  
UNDESIGNATED, BOOSTER (52 G RDX)  
UNDESIGNATED, BOOSTER (52 G COMP A-5)

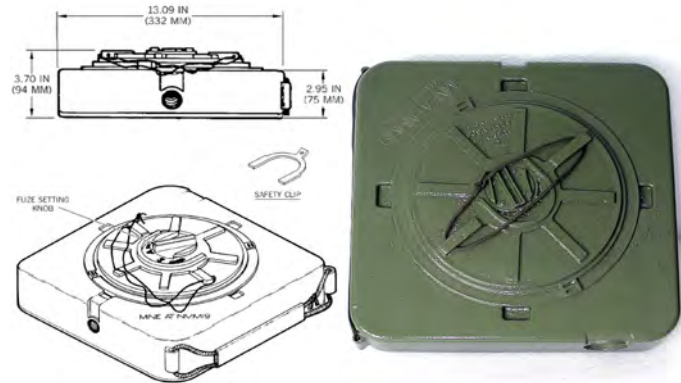

N.E.W. 21.25 LB



**UNKNOWN COUNTRY, LANDMINE, AT, MODEL UNKNOWN**

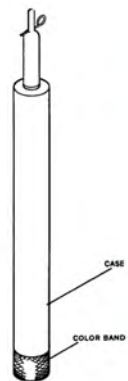
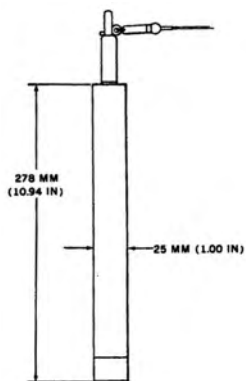

**U.S.S.R. LANDMINE, SIGNAL, SM**

Ordnance used with:  
MUV, PULL  
MUV-2, FIRING DEVICE, PULL/PRESSURE  
MUV-3, FIRING DEVICE, PULL/PRESURE



**YUGOSLAV LANDMINE, APERS, TM100**

Ordnance used with:  
 UANU-1, LANDMINE, AT, PRESS.  
 MDL. UNKNOWN, LANDMINE, PRESS.



**CANADIAN LANDMINE, APERS, CLAYMORE, C19**

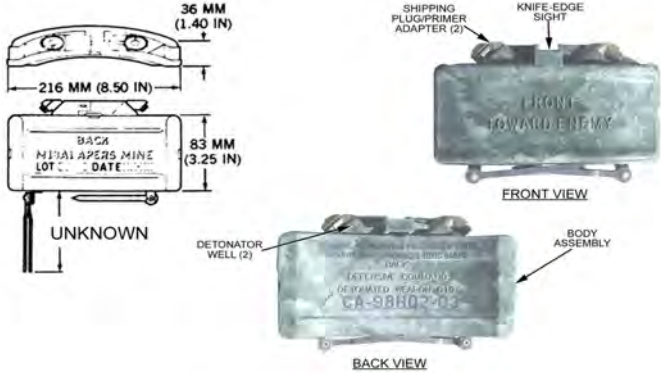

N.E.W. 680.00 G

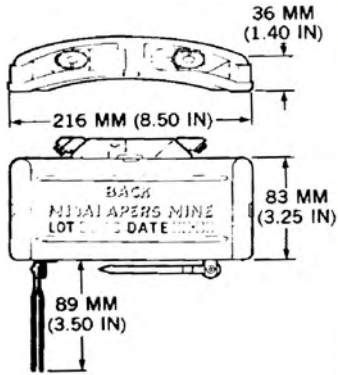

**U.S. LANDMINE, APERS, HE, M18A1; & PRACTICE, M68**

N.E.W. 680.00 G

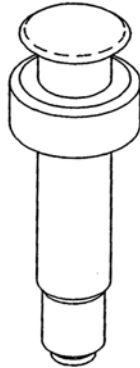
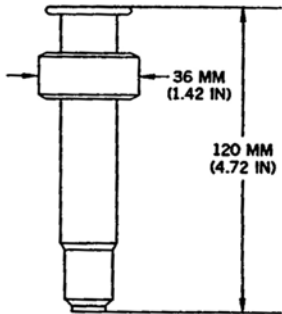

**U.S.S.R. LANDMINE, APERS, PMP**

## ZIMBABWE LANDMINES, APERS, ZAP-1 AND ZAP-2

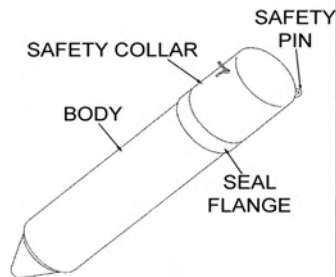

N.E.W. 140.00 G

## EGYPTIAN LANDMINE, APERS, (HAMDY)

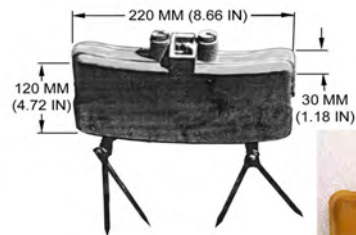

N.E.W. 501.60 G

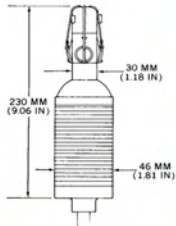

**BELGIAN LANDMINE, APERS, MODEL NR 413**



N.E.W. 95.00 G

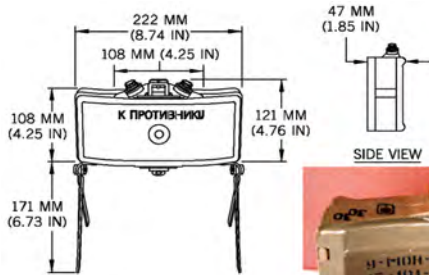

**U.S.S.R. LANDMINE, APERS, FRAG, MON-50**

Ordnance used with:  
 MUV-4, PULL  
 NVU-P, LANDMINE CTRL. DEVICE  
 VP-12, LANDMINE CTRL. DEVICE  
 NVU-PM, LANDMINE CTRL. DEVICE  
 VP-13, LANDMINE CTRL. DEVICE

**U.S. LANDMINES, APERS, HE, M14 & M14E1; &  
LANDMINE, APERS, PRACTICE, M17**

Ordnance used with:  
T1204, AP

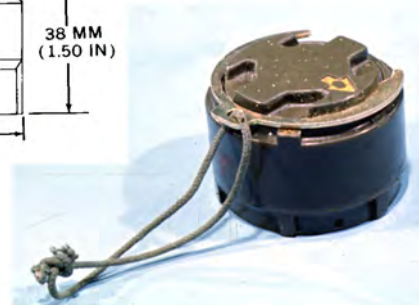
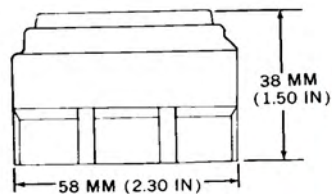

N.E.W. 29.00 G

**CHINESE LANDMINE, APERS, STAKE, TYPE 58**

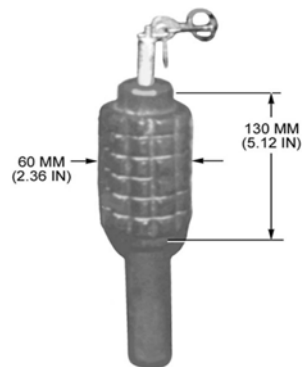

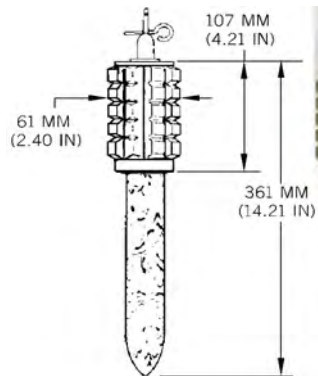

## U.S.S.R. LANDMINE, APERS, POMZ-2M

Ordnance used with:

MUV-4, PULL

MDL. UNKNOWN, PULL

MUV, PULL

MUV-2, FIRING DEVICE, PULL/PRESSURE

MUV-3, FIRING DEVICE, PULL/PRESSURE

MV-5, FUZE, LANDMINE, AT, PRESS.

NM, INITIATOR, ELEC.

N.E.W. 75.00 G

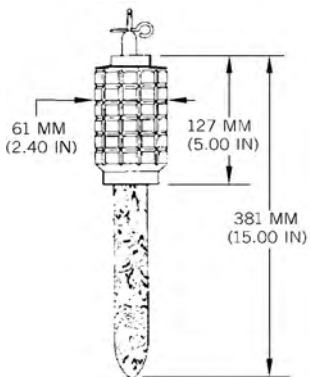

## U.S.S.R. LANDMINES, APERS, POMZ-2 AND PRACTICE, UIPOMZ-2

Ordnance used with:

MUV-4, PULL

MDL. UNKNOWN, PULL

MUV, PULL

MUV-2, FIRING DEVICE, PULL/PRESSURE

MUV-3, FIRING DEVICE, PULL/PRESSURE

MV-5, FUZE, LANDMINE, AT, PRESS.

NM, INITIATOR, ELEC.

N.E.W. 75.00 G

## IRANIAN LANDMINE, APERS, NO. 4 (PEDAL)

Ordnance used with:  
MDL. UNKNOWN, LANDMINE, PRESS. (FOR NO. 4 PEDAL)

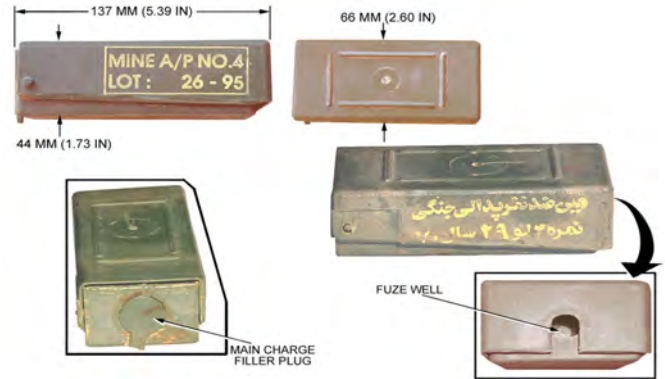

## YUGOSLAV LANDMINES, APERS, PMA-2; AND PRACTICE, VPMA-2

Ordnance used with:  
UPMAH-2, LANDMINE, APERS, PRESS.

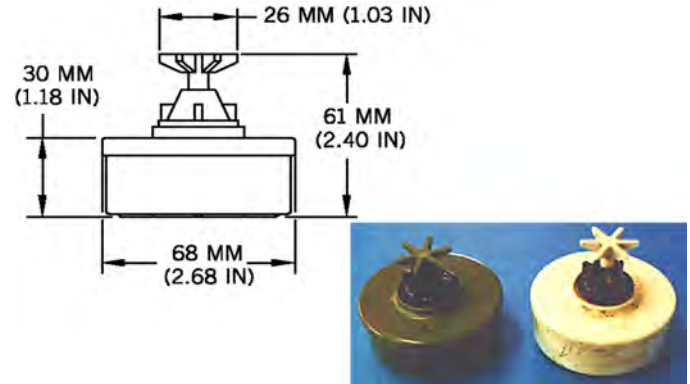

N.E.W. 100.00 G

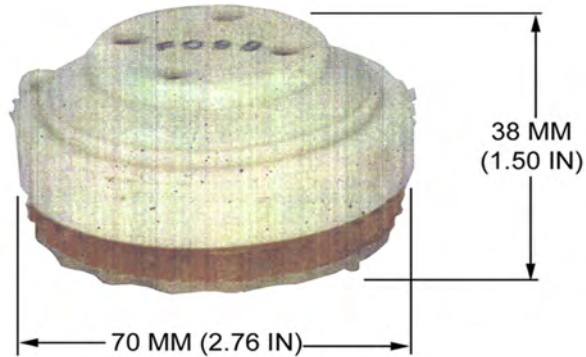

## PAKISTANI LANDMINE, APERS, P2 MK2

Ordnance used with:  
 P2 MK2, AT, NONMETALLIC  
 P3 MK 2, AT

N.E.W. 58.00 G

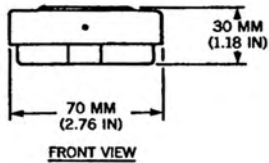
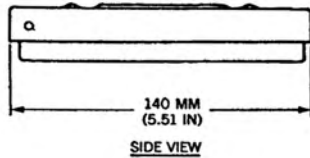

## YUGOSLAV LANDMINES, APERS, PMA-1, PMA-1A, & PRACTICE, VPMA-1A

Ordnance used with:  
 UPM-1, FIRING DEVICE, PULL/PRESSURE/TENSION R...  
 UPMAH-1, LANDMINE, APERS, PRESS.

N.E.W. 200.00 G



## PAKISTANI LANDMINE, AP, JUMPING, MODEL P7 MK1

Ordnance used with:  
P-1 MK 1, HAND, FRAG  
P1 MK 1, HAND, FRAG

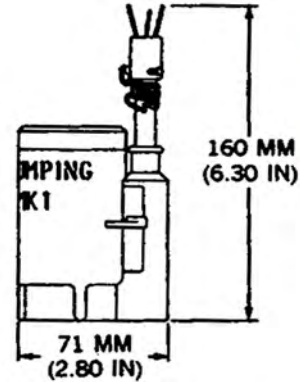

## YUGOSLAV LANDMINES, APERS, BOUNDING, (FRAG), PROM-1 AND PRACTICE VPROM-1

Ordnance used with:  
UPROM-1, LANDMINE, APERS, PRESSURE/PULL  
M61-1, LANDMINE, APERS, PULL



N.E.W. 448.00 G

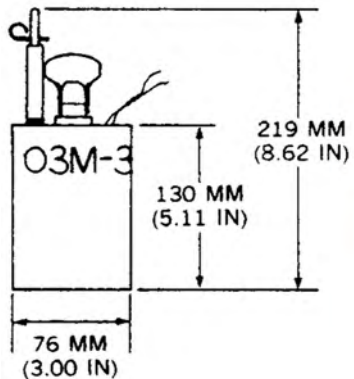

**U.S.S.R. LANDMINE, APERS, OZM-3**

N.E.W. 75.00 G

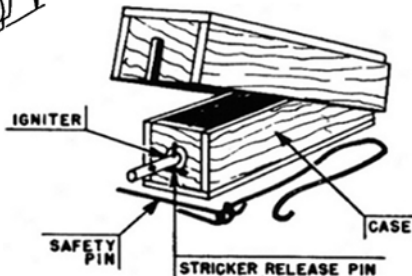
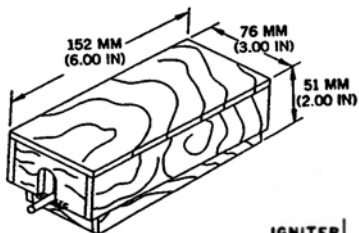

**U.S.S.R. LANDMINES, APERS, PMD-7 & PMD-7TS**

N.E.W. 200.00 G

## CHINESE LANDMINES, APERS, TYPES 72, 72B, AND 72C

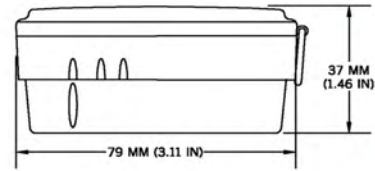

N.E.W. 51.00 G

## BELGIAN LANDMINE, APERS, PRB-M409

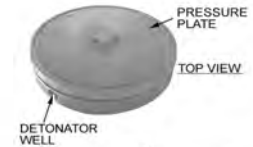
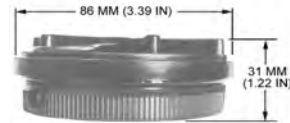

N.E.W. 0.18 LB

## U.K. LANDMINE, APERS, BOUNDING, MK II (MK 2)

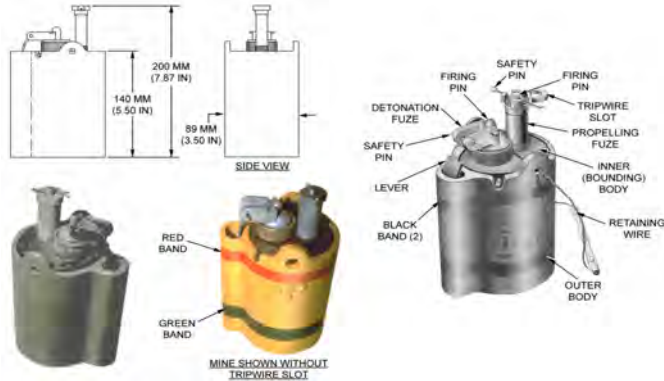

N.E.W. 500.00 G

## U.S. LANDMINES, APERS, HE, M3, M3A1, & M3B1; LANDMINE, INERT, M3

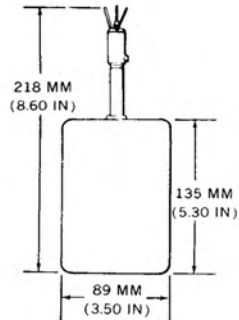

Ordnance used with:  
M3, LANDMINE, APERS, PULL/PRESSURE  
M7, LANDMINE, PULL/PRESSURE

N.E.W. 1.00 LB

## U.S.S.R. LANDMINES, APERS, PMD-6 AND PMD-6M

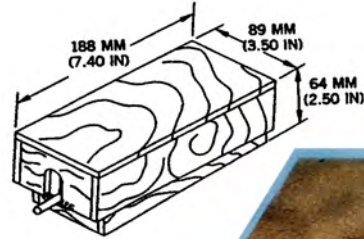

N.E.W. 200.00 G

## U.S.S.R. LANDMINE, APERS, BOUNDING, OZM-4

Ordnance used with:

MUV-4, PULL

MUV, PULL

MUV-2, FIRING DEVICE, PULL/PRESSURE

MUV-3, FIRING DEVICE, PULL/PRESURE

VPF, FIRING DEVICE, PULL

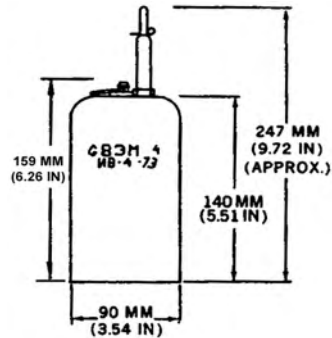

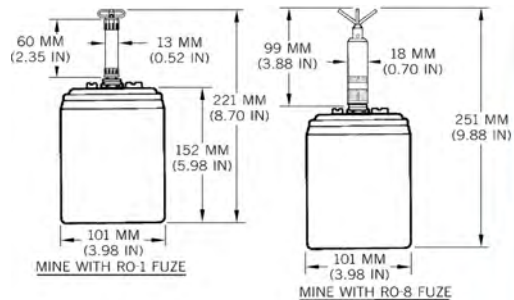

## CZECHOSLOVOKIAN LANDMINES, APERS, PP-MI-SR AND PP-MI-SR II

Ordnance used with:  
 RO-1, LANDMINE, PULL/PRESSURE  
 RO-8, LANDMINE, PRESS.  
 UPM-1, FIRING DEVICE, PULL/PRESS./TENSION RELEASE

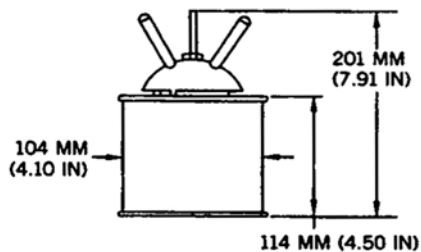

## ITALIAN LANDMINES, APERS, VALMARA AND VALMARA 59

Ordnance used with:  
 UNDESIGNATED, LANDMINE, APERS, PRESSURE/PULL

N.E.W. 564.00 G

## U.S. LANDMINES, APERS, HE, M16 AND M16A1; AND LANDMINES, INERT, M16 AND M16A1

Ordnance used with:  
M605, FUZE, LANDMINE, AP, COMBINATION

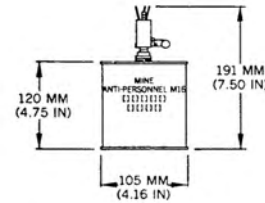

N.E.W. 553.00 G

## U.S.S.R. LANDMINE, APERS, MODEL OZM-72

Ordnance used with:  
NVU-P, LANDMINE CTRL. DEVICE  
VP-12, LANDMINE CTRL. DEVICE  
NVU-PM, LANDMINE CTRL. DEVICE  
VP-13, LANDMINE CTRL. DEVICE  
MUV, PULL  
MUV-2, FIRING DEVICE, PULL/PRESSURE



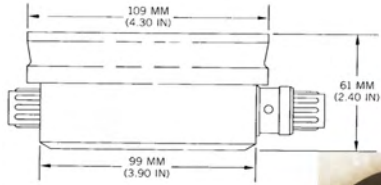

**HUNGARIAN LANDMINE, APERS, GYATA-64**

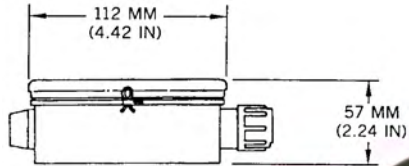

**U.S.S.R. LANDMINE, APERS, PMN**

Ordnance used with:  
SVP, PYROTECHNIC ARMING DEVICE

N.E.W. 227.00 G



## U.S.S.R. LANDMINE, APERS, PMN-2

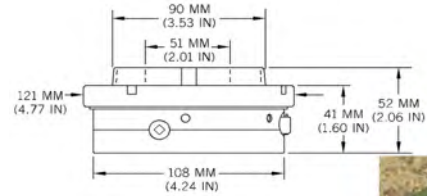

N.E.W. 115.00 G

## U.S.S.R. LANDMINE, AT, YAM-5

Ordnance used with:  
MUV, PULL

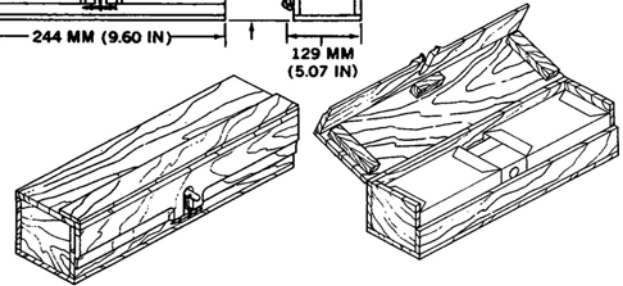
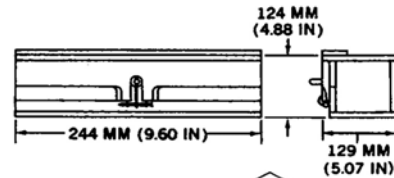

N.E.W. 5.20 KG

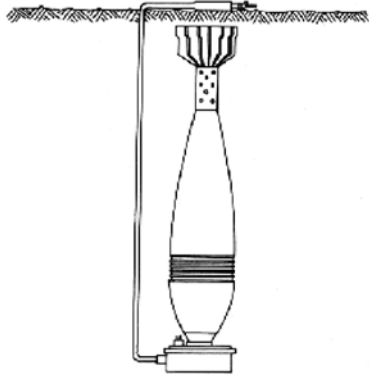

**U.S.S.R. LANDMINE, APERS, OZM**

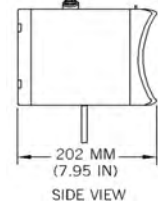

**U.S.S.R. LANDMINE, APERS, FRAG, MON-90**

Ordnance used with:  
MUV-4, PULL  
NVU-PM, LANDMINE CTRL. DEVICE  
VP-13, LANDMINE CTRL. DEVICE  
MUV, PULL  
MUV-2, FIRING DEVICE, PULL/PRESSURE

**U.K. LANDMINES, AT, GS MK V, & GS MK V, HC**

Ordnance used with:  
NO. 3 MK 1, LANDMINE, AT, PRESS.

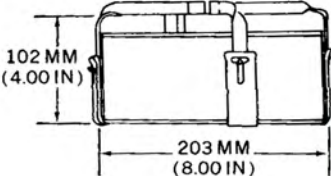

**EGYPTIAN LANDMINE, AT, M/80**

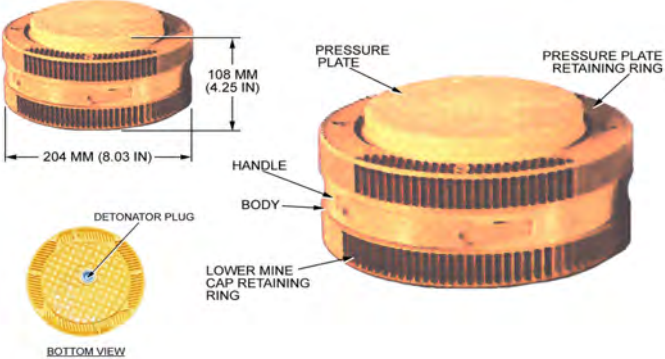

N.E.W. 2.40 KG

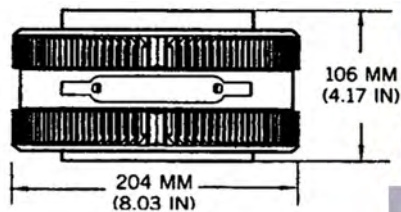

### ITALIAN LANDMINE, AT, TC/2.4

Ordnance used with:  
MDL. UNKNOWN, ANTILIFT

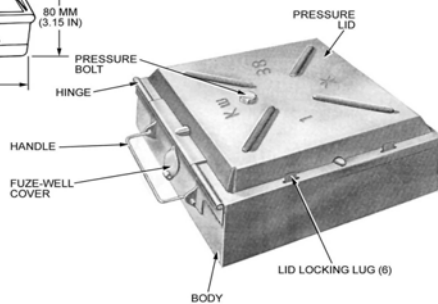
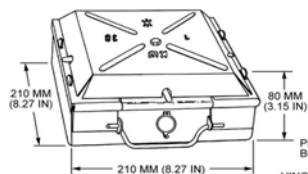

### U.S.S.R. LANDMINE, AT, TM-38

Ordnance used with:  
MUV, PULL  
UV, FIRING DEVICE, PULL

N.E.W. 2.80 KG

## BELGIAN LANDMINE, AT, PRB M3A1

Ordnance used with:  
PRB-M30, ANTLIFT DEVICE  
M60, LANDMINE, PRESS.  
PRB MIG M60, LANDMINE, PRESS.  
PRB 2144, FIRING DEVICE, PULL

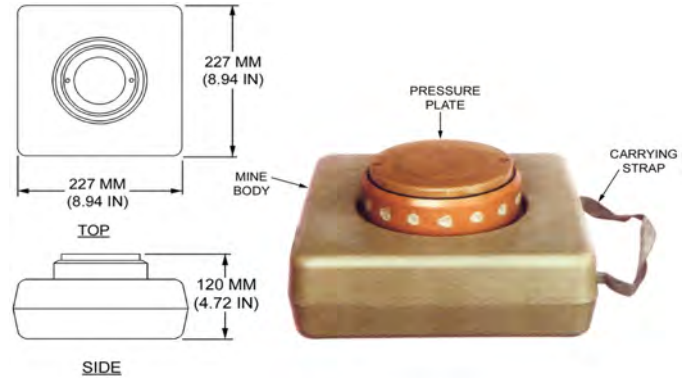

N.E.W. 6.00 KG

## ITALIAN LANDMINE, AT, SB-81; SPANISH C-5; PORTUGUESE M/453; AND IRANIAN YM-II

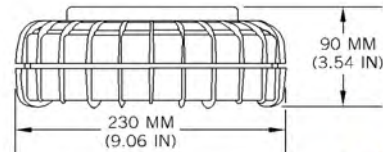

N.E.W. 2.20 KG

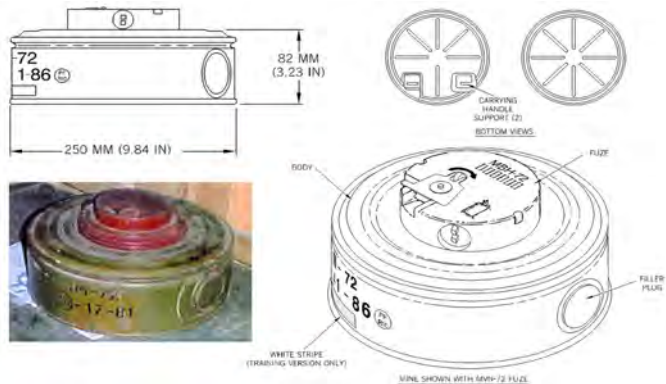

## U.S.S.R. LANDMINE, AT TM-72

N.E.W. 2.50 KG

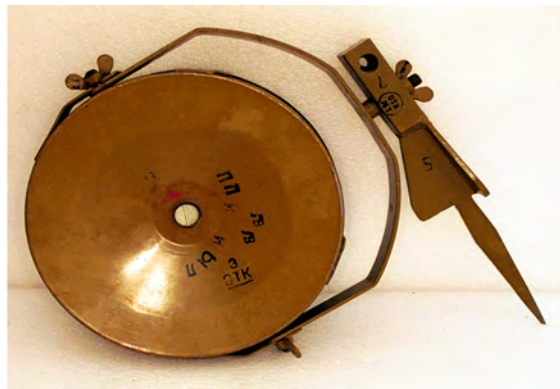

## U.S.S.R. LANDMINE, APERS, MON-100

Ordnance used with:

- MUV-4, PULL
- NVU-P, LANDMINE CTRL. DEVICE
- VP-12, LANDMINE CTRL. DEVICE
- NVU-PM, LANDMINE CTRL. DEVICE
- VP-13, LANDMINE CTRL. DEVICE
- MUV, PULL

N.E.W. 2.16 KG

## U.S.S.R. LANDMINES, AT, TM-41 & TM-44

Ordnance used with:  
MV-5, FUZE, LANDMINE, AT, PRESS.  
MV-5K, FUZE, LANDMINE, AT, PRESS.

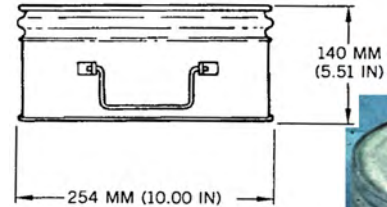

## ITALIAN LANDMINE, AT, SH-55

Ordnance used with:  
VS-N-TLC, ELEC, FIELD PROGRAMMABLE, R/C PRESS...  
VS-N-EL2, ELEC, FIELD PROGRAMMABLE, PRESS./AN...  
VS-N/AR-AN, ELECTRONIC, ANIT-REMOVAL/DISTRUBANCE  
VS-N, PRESSURE-ACTUATED  
FD-64, LANDMINE, AT, PRESS.  
SH-160, LANDMINE, AT, PRESS.

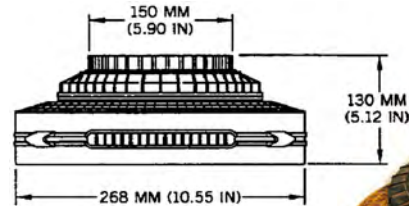

N.E.W. 5528.00 G

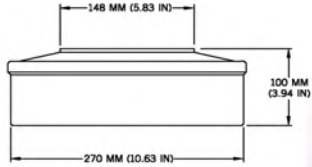

## CHINESE LANDMINE, AT, TYPE 72

Ordnance used with:  
TYPE 69, LANDMINE, AT, DOUBLE IMPULSE  
TYPE 72A, LANDMINE, AT, (SINGLE IMPULSE)  
TYPE 81, LANDMINE, AT (SINGLE IMPULSE)  
TYPE 72, LANDMINE, AT, PRESS. (BLAST RESISTANT)  
TYPE 74, 284MM, CARGO

N.E.W. 6.60 KG

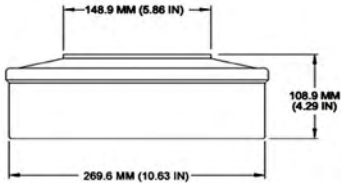

## IRANIAN LANDMINE, AT, YM-III

Ordnance used with:  
UNKNOWN, LANDMINE, AT, PRESS.

N.E.W. 5.69 KG



## ITALIAN LANDMINE, AT, ELECTRONIC, TCE/6

Ordnance used with:  
MDL. UNKNOWN, AT, ELECT. FUZE, (TCE/6)

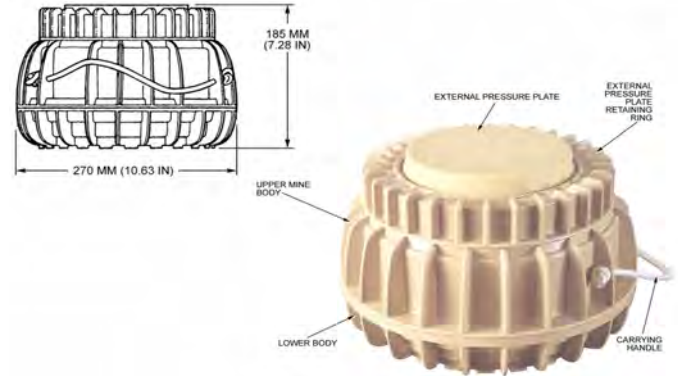

---

## ITALIAN LANDMINE, AT, TC/3.6

Ordnance used with:  
UNKNOWN, PRESSURE, LANDMINE (TC/3.6)

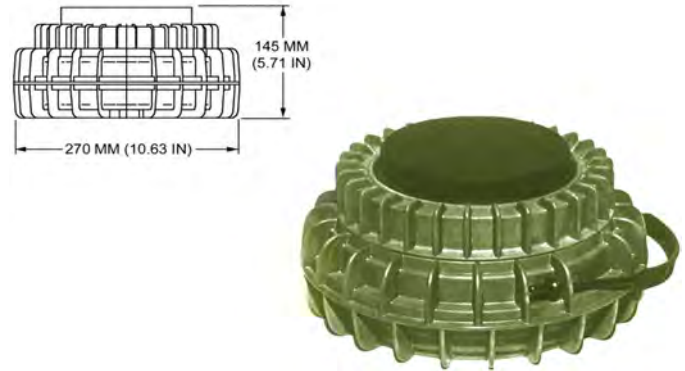

N.E.W. 3.60 KG

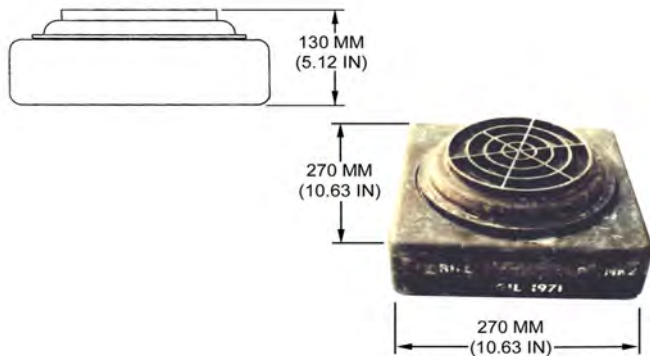

## PAKISTANI LANDMINE, AT, P2 MK 2

Ordnance used with:  
P2 MK 2, APERS

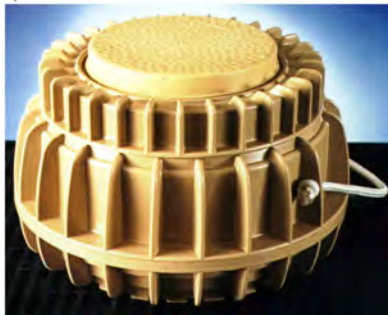
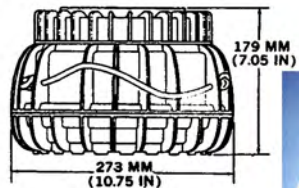

## ITALIAN LANDMINE, AT, MODEL TC-6

Ordnance used with:  
MDL. UNKNOWN, ANLIFT  
UNKNOWN, FIRING DEVICE, IMPROVISED, PHOTOELECTRIC  
MDL. UNKNOWN, FIRING DEVICE, ANLIFT

## YUGOSLAV LANDMINES, AT, NONMETALLIC, MODEL TMA-5 & PRACTICE, VTMA-5

Ordnance used with:  
UANU-1, LANDMINE, AT, PRESS.

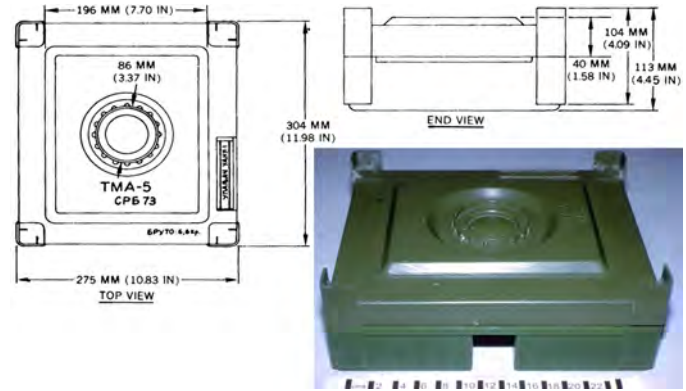

N.E.W. 5561.00 G

## U.S.S.R. LANDMINE, AT/APERS, PMZ-40

Ordnance used with:  
MUV, PULL  
MV-5, FUZE, LANDMINE, AT, PRESS.  
MV-3, FUZE, LANDMINE, AT, PRESS.  
UV, FIRING DEVICE, PULL

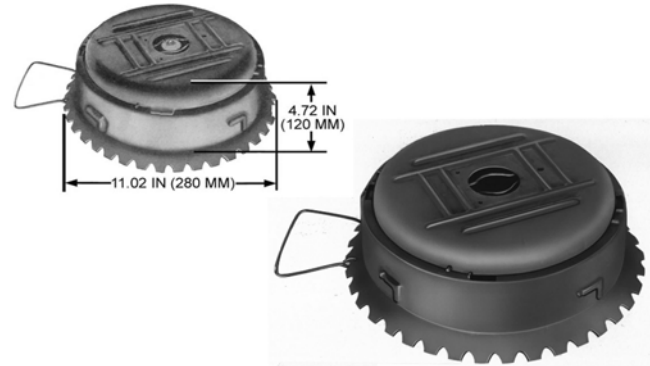

N.E.W. 8.00 LB

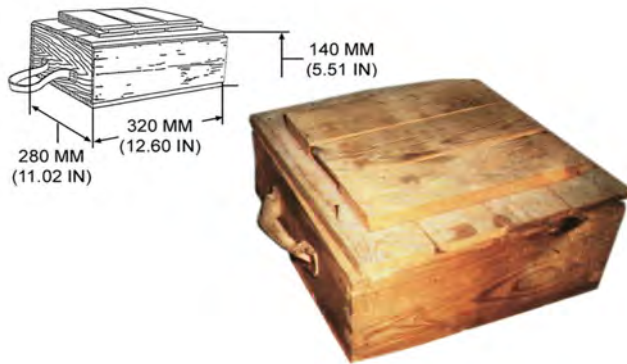

## YUGOSLAV LANDMINE, AT, TMD-1

Ordnance used with:  
 UANU-1, LANDMINE, AT, PRESS.  
 UPM-1, FIRING DEVICE, PULL/PRESSURE/TENSION R...  
 MV-5, MINE, PRESS.

N.E.W. 5.50 KG

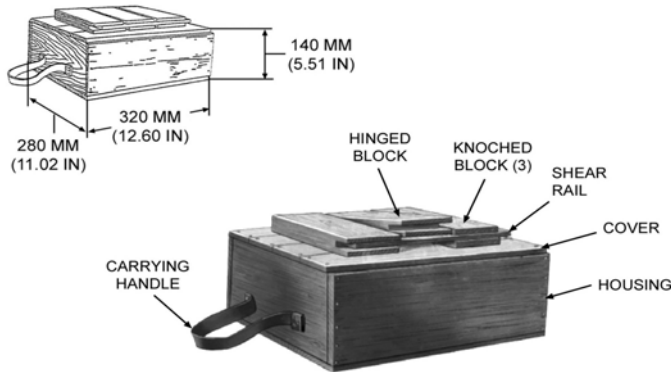

## YUGOSLAV LANDMINE, AT, TMD-2

Ordnance used with:  
 MV-5, FUZE, LANDMINE, AT, PRESS.  
 UANU-1, LANDMINE, AT, PRESS.

N.E.W. 5.50 KG

## U.S.S.R. LANDMINE, AT, TMD-B

Ordnance used with:  
MV-5, FUZE, LANDMINE, AT, PRESS.  
MV-5K, FUZE, LANDMINE, AT, PRESS.

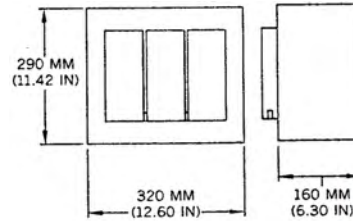

N.E.W. 6.90 KG

## U.S.S.R. LANDMINES, AT, TMD-44, AND PRACTICE, UITMD-44; AND INERT UTMD-44

Ordnance used with:  
MV-5, FUZE, LANDMINE, AT, PRESS.  
MV-5K, FUZE, LANDMINE, AT, PRESS.

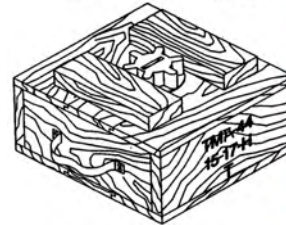
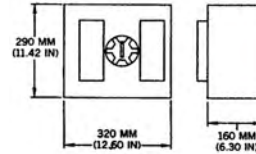

N.E.W. 6.90 KG

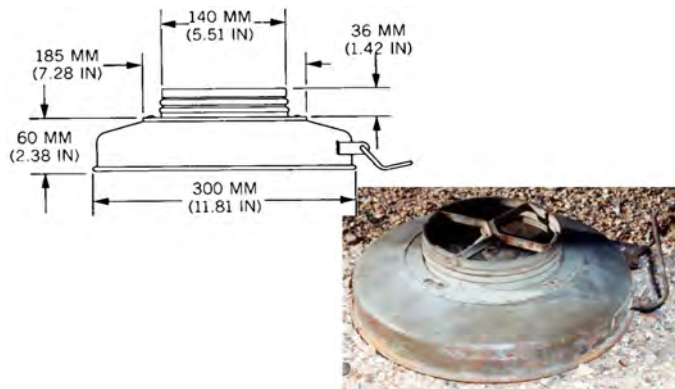

## CZECHOSLOVOKIAN LANDMINE, AT, PT-MI-K

Ordnance used with:  
 RO-3, FIRING DEVICE, PRESSURE-RELEASE  
 RO-5, LANDMINE, AT, PRESS.  
 RO-9, LANDMINE, AT, PRESS.

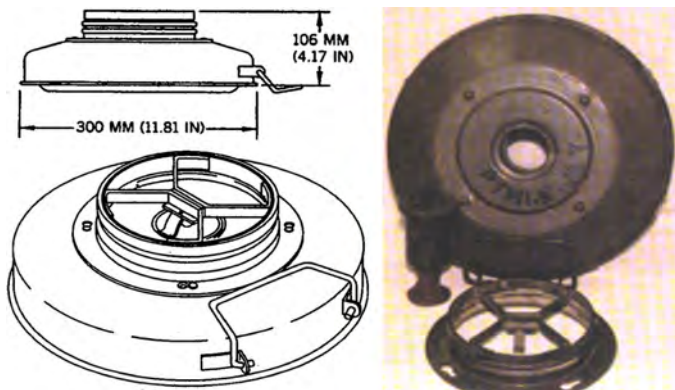

## CZECHOSLOVOKIAN LANDMINE, AT, PT-MI-K II

Ordnance used with:  
 RO-3, FIRING DEVICE, PRESSURE-RELEASE  
 RO-5, LANDMINE, AT, PRESS.

## HUNGARIAN LANDMINE, AT, UKA-63

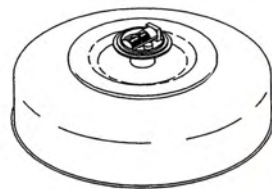

---

## U.S.S.R. LANDMINE AT, TMK-2

Ordnance used with:  
MVK-2, LANDMINE, AT, TILTROD



## SWEDISH LANDMINES, AT, MI 102 (OBSOLETE)

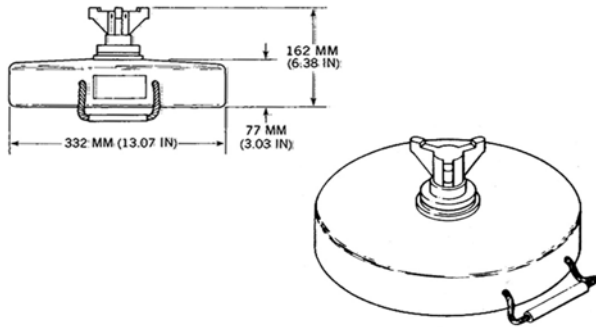

Ordnance used with:  
MDL. UNKNOWN, LANDMINE, AT, PRESS.

N.E.W. 7.50 KG

## U.S.S.R. LANDMINES, AT, TM-46 AND TMN-46; AND TRAINING, UITM-46

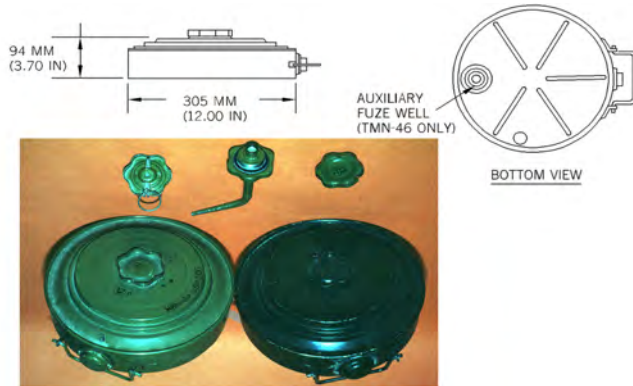

Ordnance used with:  
MUV, PULL  
MUV-2, FIRING DEVICE, PULL/PRESSURE  
MUV-3, FIRING DEVICE, PULL/PRESURE  
MV-5, FUZE, LANDMINE, AT, PRESS.  
MVM, FUZE, LANDMINE, AT, PRESS.  
MVSH-46, FUZE, LANDMINE, TILTROD



**PAKISTANI LANDMINE, AT, NONMETALLIC, MODEL P3 MK 1 (ROUND)**

Ordnance used with:  
P2 MK 2, APERS



**U.S.S.R. LANDMINE, AT, TM-57**

Ordnance used with:  
MVSH 57, LANDMINE, AT, TILTROD  
MVZ-57, LANDMINE, AT, PRESS.

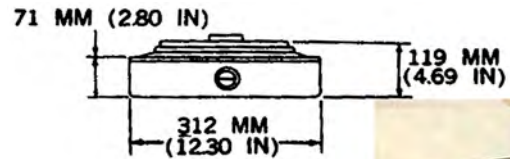



### U.S.S.R. LANDMINE, AT, TM-62B

Ordnance used with:  
MVCH-62, FUZE, LANDMINE, AT, PRESS.  
MVN-62, FUZE, LANDMINE, AT, MAGNETIC INFLUENCE  
MVP-62, FUZE, LANDMINE, AT, PRESS.  
VM-62, FUZE, LANDMINE, AT, PRESS.  
MWP-62, FUZE, LANDMINE, AT, PRESS.  
MVCH-62Z, FUZE, LANDMINE, AT, PRESS.  
VM-62Z, FUZE, LANDMINE, AT, PRESS.



### BULGARIAN LANDMINE, AT, TM-62M

Ordnance used with:  
MVCH-62, FUZE, LANDMINE, AT, PRESS.  
MVN-62, FUZE, LANDMINE, AT, MAGNETIC INFLUENCE  
MVP-62, FUZE, LANDMINE, AT, PRESS.  
NV-PTM, FUZE, LANDMINE, AT, MAGNETIC INFLUENCE  
NV-PTM-RC, AT, MAGNETIC INFLUENCE, REMOTE CTRL.  
VM-62, FUZE, LANDMINE, AT, PRESS.  
MWP-62, FUZE, LANDMINE, AT, PRESS.  
N.E.W. 5700.00 G

## U.S.S.R. LANDMINE, AT, TM-62P2

Ordnance used with:

MVCH-62, FUZE, LANDMINE, AT, PRESS.

MVN-62, FUZE, LANDMINE, AT, MAGNETIC INFLUENCE

MVP-62, FUZE, LANDMINE, AT, PRESS.

VM-62, FUZE, LANDMINE, AT, PRESS.

MWP-62, FUZE, LANDMINE, AT, PRESS.

MVCH-62Z, FUZE, LANDMINE, AT, PRESS.

VM-62Z, FUZE, LANDMINE, AT, PRESS.

N.E.W. 7200.00 G



## U.K. LANDMINE, AT, MK 7

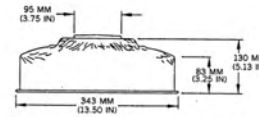

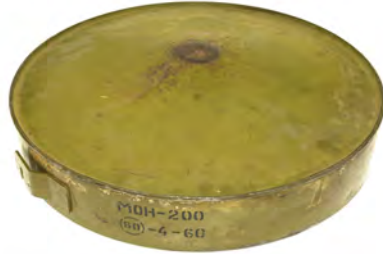
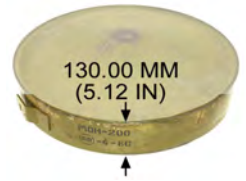
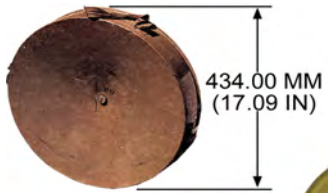

## U.S.S.R. LANDMINE, APERS, MON-200

- Ordnance used with:
- MUV-4, PULL
  - NVU-P, LANDMINE CTRL. DEVICE
  - VP-12, LANDMINE CTRL. DEVICE
  - NVU-PM, LANDMINE CTRL. DEVICE
  - VP-13, LANDMINE CTRL. DEVICE
  - MUV, PULL

N.E.W. 12.16 KG

**U.K. GUIDED MISSILE, SURFACE-TO-AIR, SURFACE-TO-SURFACE, K103A1 MK 2, BLOWPIPE**

Ordnance used with:  
LAUNCH TUBE, K103A1, BLOWPIPE



---

**U.S. GUIDED MISSILE STARTER CARTRIDGE FOR ENGINE, TURBOFAN, F107-WR-101**

Ordnance used with:  
AGM-86C, AIR-TO-SURFACE, CALCM  
OTL, PRACTICE ALCM, AGM-86C  
AGM-86D, CALCM  
UNDESIGNATED, AFT SECTION, AGM-86 SERIES

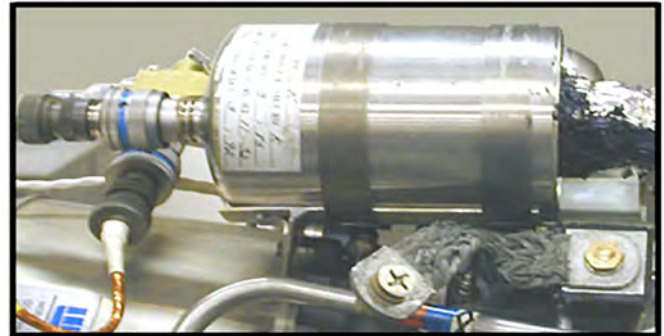

## U.S. GUIDED MISSILE SWITCH, ROTARY, SWU-58/A

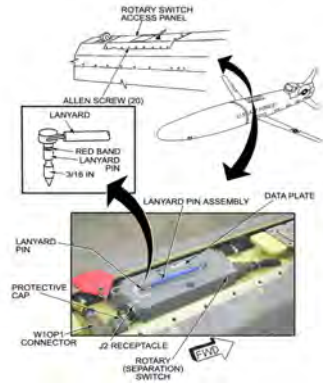

Ordnance used with:  
FMU-139A/B, NOSE & TAIL, IMPACT  
AGM-86C, AIR-TO-SURFACE, CALCM  
OTL, PRACTICE ALCM, AGM-86C  
AGM-86D, CALCM  
UNDESIGNATED, CENTER SECTION, F/AGM-86D

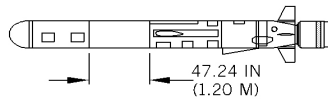

ANTISHIP VERSION  
BLAST-EFFECT WARHEAD

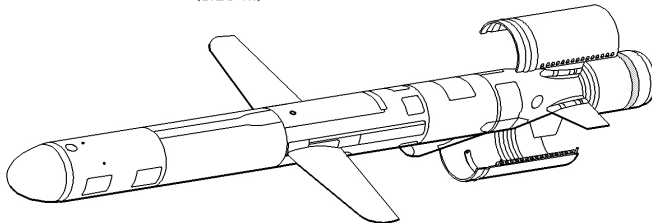

## U.S. GUIDED MISSILE WARHEADS, CONVENTIONAL (FOR RGM-/UGM-109-SERIES TOMAHAWK) (ANTISHIP VERSION BLAST EFFECT WARHEAD)

Ordnance used with:  
RGM-109B-1, GUIDED MISSILE, S-TO-S (TOMAHAWK)  
RGM-109B-3, GUIDED MISSILE, S-TO-S (TOMAHAWK)  
RGM-109B-4, GUIDED MISSILE, S-TO-S (TOMAHAWK)  
RGM-109C-1, GUIDED MISSILE, S-TO-S (TOMAHAWK)  
RGM-109C-3, GUIDED MISSILE, S-TO-S (TOMAHAWK)  
RGM-109C-4, GUIDED MISSILE, S-TO-S (TOMAHAWK)  
RGM-109D-3, GUIDED MISSILE, S-TO-S (TOMAHAWK)

**U.S. GUIDED MISSILE WARHEADS, CONVENTIONAL  
(FOR RGM-/UGM-109-SERIES TOMAHAWK) (LAND-  
ATTACK VERSION BLAST EFFECT WARHEAD)**

Ordnance used with:

- RGM-109B-1, GUIDED MISSILE, S-TO-S (TOMAHAWK)
- RGM-109B-3, GUIDED MISSILE, S-TO-S (TOMAHAWK)
- RGM-109B-4, GUIDED MISSILE, S-TO-S (TOMAHAWK)
- RGM-109C-1, GUIDED MISSILE, S-TO-S (TOMAHAWK)
- RGM-109C-3, GUIDED MISSILE, S-TO-S (TOMAHAWK)
- RGM-109C-4, GUIDED MISSILE, S-TO-S (TOMAHAWK)
- RGM-109D-3, GUIDED MISSILE, S-TO-S (TOMAHAWK)

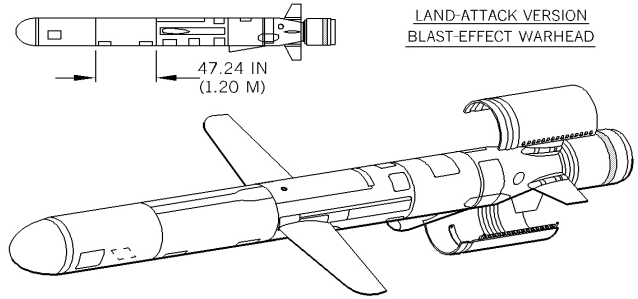

**U.S. GUIDED MISSILE WARHEADS, CONVENTIONAL  
(FOR RGM-/UGM-109-SERIES TOMAHAWK) (LAND-  
ATTACK VERSION SUBMUNITION LOADED)**

Ordnance used with:

- RGM-109B-1, GUIDED MISSILE, S-TO-S (TOMAHAWK)
- RGM-109B-3, GUIDED MISSILE, S-TO-S (TOMAHAWK)
- RGM-109B-4, GUIDED MISSILE, S-TO-S (TOMAHAWK)
- RGM-109C-1, GUIDED MISSILE, S-TO-S (TOMAHAWK)
- RGM-109C-3, GUIDED MISSILE, S-TO-S (TOMAHAWK)
- RGM-109C-4, GUIDED MISSILE, S-TO-S (TOMAHAWK)
- RGM-109D-3, GUIDED MISSILE, S-TO-S (TOMAHAWK)

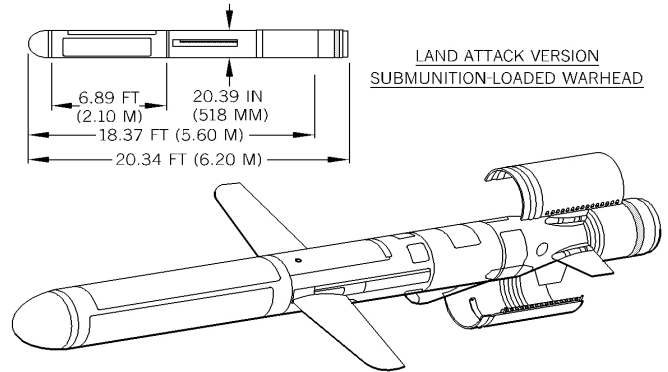



**U.S.S.R. GUIDED MISSILE, SURFACE-TO-SURFACE,  
TRAINING, AT-2C (SWATTER)**



**CHINESE GUIDED MISSILE, SURFACE-TO-AIR, HN-5**





**U.S. GUIDED MISSILE LAUNCHERS, SURFACE-TO-AIR, FIM-92A, FIM-92B, FIM-92C, FIM-92D, AND FIM-92E (STINGER)**

Ordnance used with:  
T61, ELEC. DET.



N.E.W. 11.30 LB

**U.S. GUIDED MISSILE, AIR DEFENSE, M41 (REDEYE) / FIM-43**

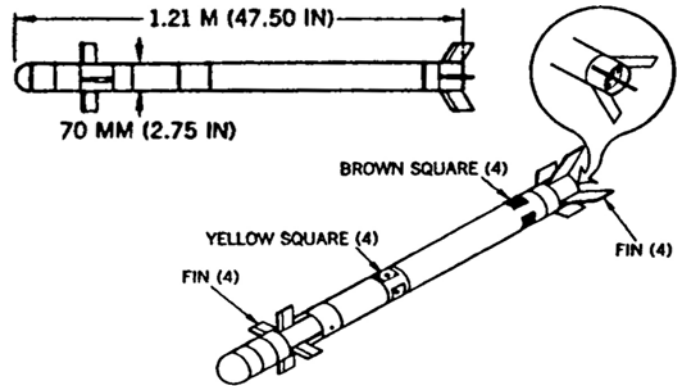

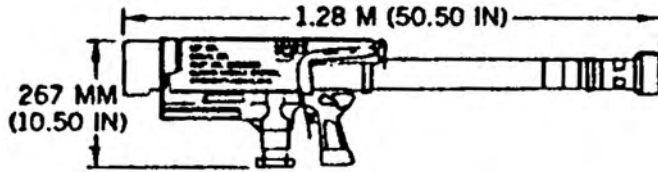

**U.S. GUIDED MISSILE, AIR DEFENSE, M41 (REDEYE) / FIM-43 (LAUNCHER)**

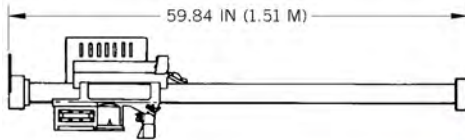

**U.S. GUIDED MISSILES, SURFACE-TO-AIR, FIM-92A, FIM-92B, FIM-92C, FIM-92D, AND FIM-92E (STINGER) (LAUNCHER)**

Ordnance used with:  
T61, ELEC. DET.



N.E.W. 11.30 LB

## U.S.S.R. GUIDED MISSILE, SURFACE-TO-AIR, SA-14



---

## U.S.S.R. GUIDED MISSILES, SA-7A, SA-7B, AND SA-N-5 (GRAIL)

Ordnance used with:  
9K32M SYSTEM, USES SA-7B MISSILE  
ZUR-23-2S, GUN/MISSILE AIR DEFENSE SYSTEM,



MARKINGS

**U.S.S.R. GUIDED MISSILE, SURFACE-TO-AIR, SA-16  
AND PRACTICE (GIMLET)**



Ordnance used with:  
9K310E SYSTEM, SA-16 MISSILE



---

**U.S.S.R. GUIDED MISSILE, SURFACE-TO-AIR, SA-18  
(GARGOYLE)**



Ordnance used with:  
MDL. UNKNOWN, GUIDED MISSILE EJECTION MOTOR  
9P39, GUIDED MISSILE SYS. (SA-18)



## U.K. GUIDED MISSILES, SURFACE-TO-AIR, BLOWPIPE

Ordnance used with:  
EJECT MOTOR, MDL. UNKNOWN, BLOWPIPE, K102A1 MK 2  
CTRL. SECTION, MDL. UNKNOWN, BLOWPIPE, K102A1...  
LAUNCH TUBE, MDL. UNKNOWN, BLOWPIPE, K102A1 MK 2



## FRENCH GUIDED MISSILE, SURFACE-TO-SURFACE, MILAN

Ordnance used with:  
UNDESIGNATED, PIBD-ELECTRIC (MILAN, MILAN 2)

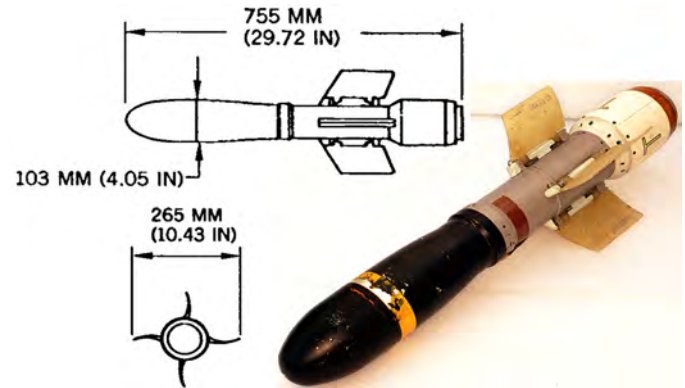

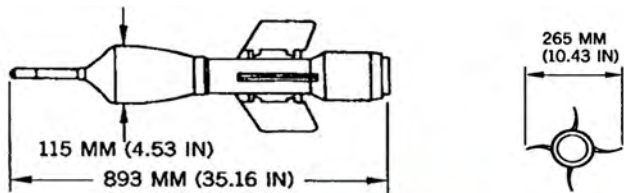

## FRENCH GUIDED MISSILE, SURFACE-TO-SURFACE, MILAN 2

Ordnance used with:  
UNDESIGNATED, PIBD-ELECTRIC (MILAN, MILAN 2)  
WARHEAD, MDL. UNKNOWN, MILAN 2  
RKT MOTOR, MDL. UNKNOWN, MILAN 2  
GUIDANCE & CONTROL, MDL. UNKNOWN, MILAN 2  
LAUNCH TUBE, MDL. UNKNOWN, MILAN 2



## U.S.S.R. GUIDED MISSILE, AT-4A (SPIGOT A)

Ordnance used with:  
LAUNCHER, AT-4 SPIGOT

**U.S.S.R. GUIDED MISSILE, AA-8A**



---

**U.S.S.R. GUIDED MISSILE, AA-8B**



## **U.S.S.R. GUIDED MISSILE, SURFACE-TO-AIR, SA-13B (GOPHER)**



Ordnance used with:  
MDL. UNKNOWN, MOTOR, SOLID PROPELLANT (SA-13B)  
UNKNOWN, LASER PROX. (SA-13B)  
UNKNOWN, WARHEAD, HE, DISCRETE-RODS (SA-13B)  
UNKNOWN, IMPACT (SA-13B)  
UNKNOWN, SEEKER, EO/IR (SA-13B)

---

## **U.S.S.R. GUIDED MISSILE, SURFACE-TO-SURFACE, AT-3A (SAGGER)**



Ordnance used with:  
WHD. AT-3A & AT-3C MALYUTKA, SAGGER  
RKT MOTOR, AT-3A & AT-3C, MALYUTKA, SAGGER  
GUIDANCE & CTRL, AT-3A & AT-3C MALYUTKA, SAGGER



## U.S.S.R. GUIDED MISSILE, SURFACE-TO-SURFACE, AT-3C (SAGGER)

Ordnance used with:  
WHD. AT-3A & AT-3C MALYUTKA, SAGGER  
RKT MOTOR, AT-3A & AT-3C, MALYUTKA, SAGGER  
GUIDANCE & CTRL, AT-3A & AT-3C MALYUTKA, SAGGER



---

## U.S.S.R. GUIDED MISSILE, SURFACE-TO-SURFACE, AT-5 (SPANDREL)

Ordnance used with:  
GUIDANCE SECTION AT-5A SPANDREL KONKURS  
WHD. AT-5A, SPANDREL, 9M113, KONKURS  
RKT MOTOR AT-5A, SPANDREL, 9M113, KONKURS





## U.S.S.R. GUIDED MISSILES, SURFACE-TO-AIR, SA-9A AND SA-9B (GASKIN)

Ordnance used with:  
SA-9, GASKIN, SPECIFIC MDL. UNK.



## U.S.S.R. GUIDED MISSILE, AIR-TO-SURFACE, AT-6 (SPIRAL)

Ordnance used with:  
U.S.S.R. RKT MOTOR, MDL. UNK. (AT-6A/SPIRAL)  
U.S.S.R. EJECT MOTOR, MDL. UNK. (AT-6A/SPIRAL)  
U.S.S.R. LAUNCH TUBE, MDL. UNK. (AT-6A/SPIRAL)



**U.S.S.R. GUIDED MISSILE, WIRE, AT (SNAPPER)**

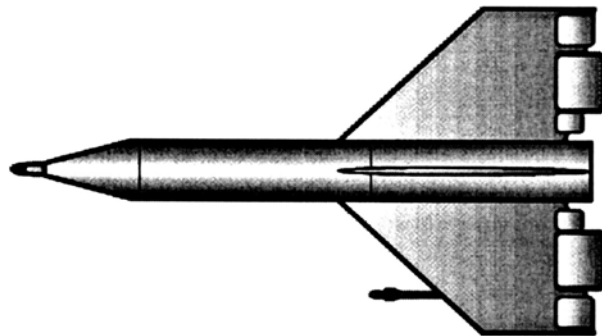

**U.S.S.R. GUIDED MISSILE, SURFACE-TO-SURFACE, AT-2C (SWATTER)**



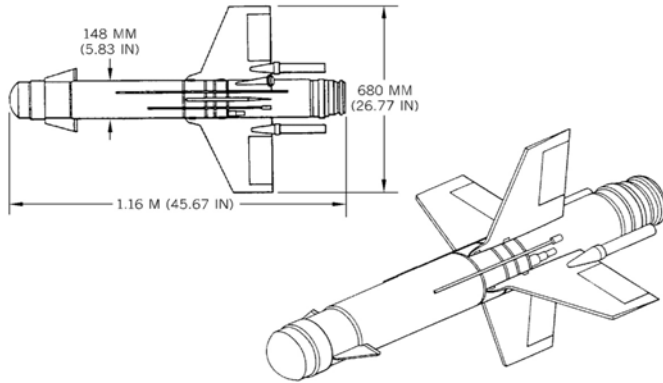

**U.S.S.R. GUIDED MISSILE, SURFACE-TO-SURFACE  
AND AIR-TO-SURFACE, AT-2A SWATTER A**

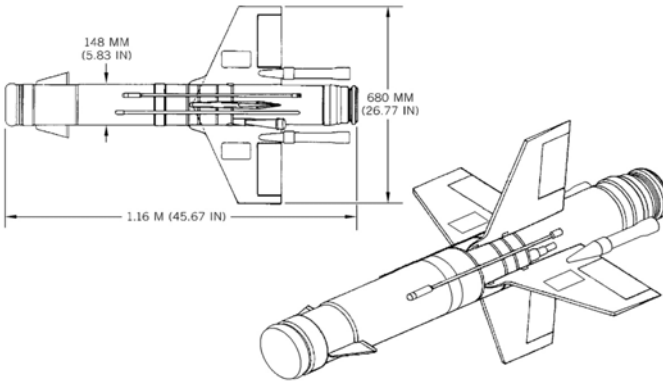

**U.S.S.R. GUIDED MISSILE, SURFACE-TO-SURFACE  
AND AIR-TO-SURFACE, AT-2B SWATTER B**

## U.S. GUIDED MISSILE, AIR-TO-SURFACE, AGM-114K (HELLFIRE II)

Ordnance used with:

AH-64A, HELICOPTER, (APACHE)  
AH-1W, AIRCRAFT, HELICOPTER (COBRA)  
UH-3A, AIRCRAFT, HELICOPTER (SEA KING)  
UH-60 SERIES, AIRCRAFT, HELICOPTERS (BLACK HAWK)  
M120E2, RKT MOTOR, (THIOKOL)  
M120E4, RKT MOTOR, (HERCULES)  
GUIDANCE SECTION, AGM-114 (DESIGNATION UNKNOWN)

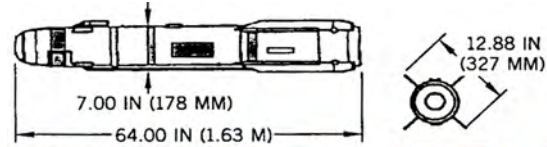

## U.S. GUIDED MISSILES, AIR-TO-SURFACE, AGM-65E & TRAINER, A/A37A-T9 (MAVERICK)

Ordnance used with:

LAU-88/A, LAUNCHER, MISSILE (MAVERICK)  
LAU-88A/A, LAUNCHER, MISSILE (MAVERICK)  
LAU-117/A, MISSILE LAUNCHER, AIRCRAFT  
WDU-24/B, WARHEAD, PENETRATOR, AGM-65G  
FMU-135/B, ELECTROMECHANICAL, GUIDED MISSILE,...  
RKT MOTOR, AGM-65E

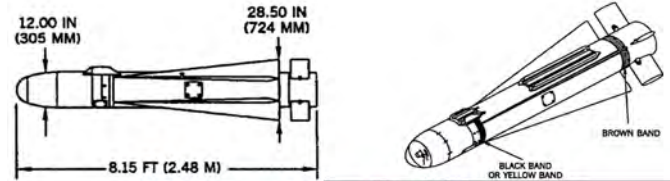

N.E.W. 148.80 LB

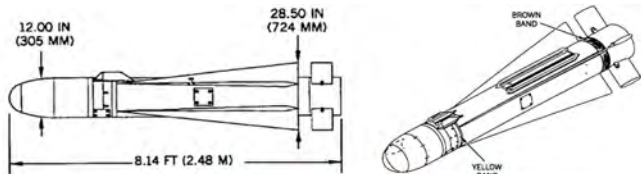

## U.S. GUIDED MISSILES, AIR-TO-SURFACE, AGM-65F & TRAINER, TGM-65F (MAVERICK)

Ordnance used with:

- LAU-88/A, LAUNCHER, MISSILE (MAVERICK)
- LAU-88A/A, LAUNCHER, MISSILE (MAVERICK)
- LAU-117/A, MISSILE LAUNCHER, AIRCRAFT
- WDU-24/B, WARHEAD, PENETRATOR, AGM-65G
- FMU-135/B, ELECTROMECHANICAL, GUIDED MISSILE,...
- RKT MOTOR, AGM-65F

N.E.W. 148.60 LB

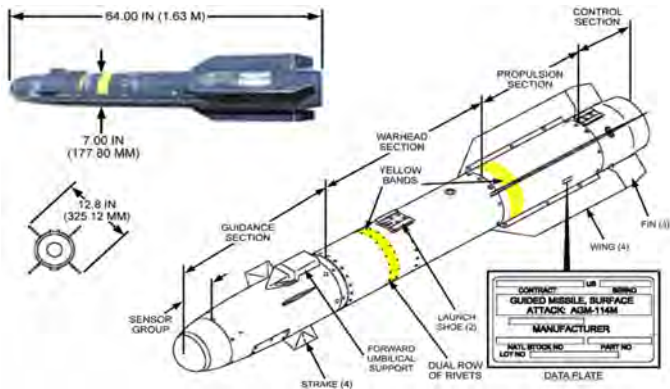

## U.S. GUIDED MISSILE, AIR-TO-SURFACE, AGM-114M

Ordnance used with:

- AH-64A, HELICOPTER, (APACHE)
- M120E1, RKT MOTOR, (THIOKOL), HELLFIRE
- M120E3, RKT MOTOR, (HERCULES)
- M120E4, RKT MOTOR, (HERCULES)
- GUIDANCE SECTION, AGM-114 (DESIGNATION UNKNOWN)
- UNDESIGNATED, WHD. SECTION, BLAST FRAG (F/ AG...
- ESAF MODULE, AGM-114 (DESIGNATION UNKNOWN)

## U.S. GUIDED MISSILE (GUIDED DISPENSER), AIR-TO-SURFACE, AGM-154A (JSOW)

Ordnance used with:  
BLU-97B/B, HEAT  
FSU-24/B, ELECT. SAFE & ARM DEVICE (SAD)  
EUROFIGHTER, TYPHOON  
DISP. PAYLOAD, AGM-154A, (UNKNOWN DESIGNATION)

N.E.W. 92.60 LB



## U.S. GUIDED MISSILES, AIR-TO-SURFACE, AGM-84H & TRAINER ATM-84H (SLAM-ER)

Ordnance used with:  
FZU-47/B, AIR PRESS. PROBE, GUIDED MISSILE  
FMU-155/B, FUZE  
FZU-56/B, AIR PRESS. PROBE  
BBU-60/B, BOOSTER  
WAU-30C (V2) / B, WHD. SECTION  
WDU-40 / B, WHD.  
J402, SUSTAINER MOTOR, TURBOFAN

N.E.W. 350.00 LB

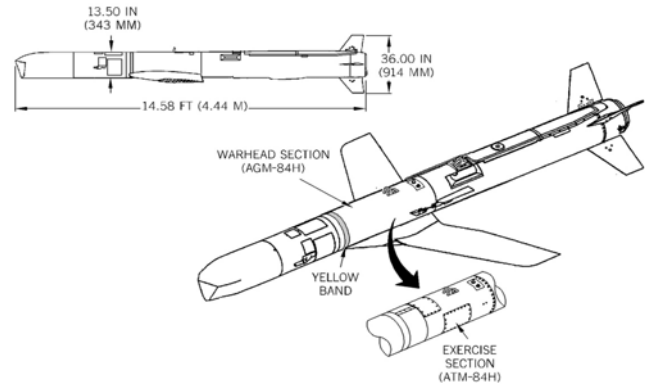

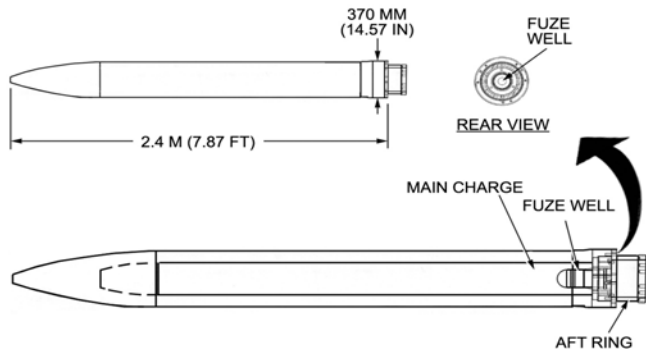

## U.S. GUIDED MISSILE WARHEAD, 1,200-LB, HE-PENETRATION, AUP-3 (M)

Ordnance used with:  
 AGM-86D, CALCM  
 FMU-159/B, BOMB, TAIL, HTSF  
 UNDESIGNATED, CENTER SECTION, F/AGM-86D

N.E.W. 43.09 KG

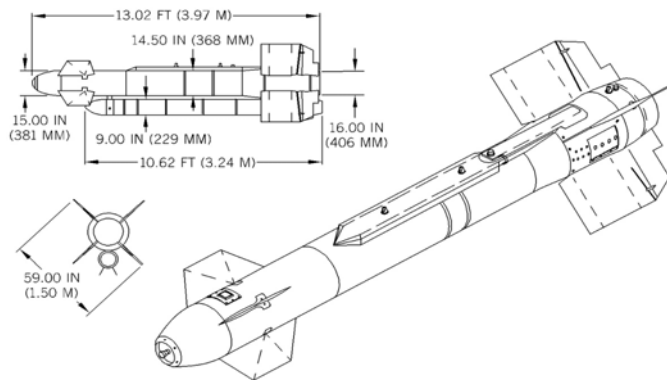

## U.S. GUIDED MISSILE, AIR-TO-SURFACE, AGM-130C

Ordnance used with:  
 BLU-109/B, PENETRATOR  
 FMU-143B/B, NOSE & TAIL, IMPACT  
 FMU-152/B, BOMB FUZE, TAIL  
 JPF  
 DSU-27B/B, GUIDANCE CTRL. UNIT, GUIDED MISSILE  
 WGU-33/B, GUIDANCE CTRL. UNIT, GUIDED MISSILE  
 WGU-40/B, GUIDANCE CTRL. UNIT, GUIDED MISSILE



## U.S.S.R. GUIDED MISSILE, AIR-TO-SURFACE, AS-9 (KYLE)



## U.S. GUIDED MISSILE, AIR-TO-SURFACE, AGM-130A

Ordnance used with:  
FMU-124A/B, NOSE & TAIL, IMPACT  
FMU-152/B, BOMB FUZE, TAIL  
JPF

MK 84, 2000-LB, GP  
DSU-27B/B, GUIDANCE CTRL. UNIT, GUIDED MISSILE  
WGU-33/B, GUIDANCE CTRL. UNIT, GUIDED MISSILE  
WGU-40/B, GUIDANCE CTRL. UNIT, GUIDED MISSILE

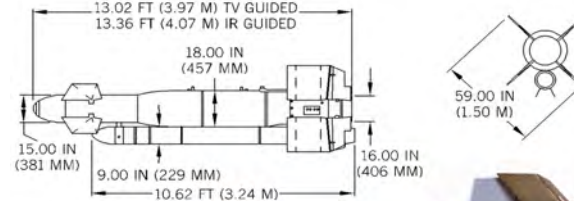

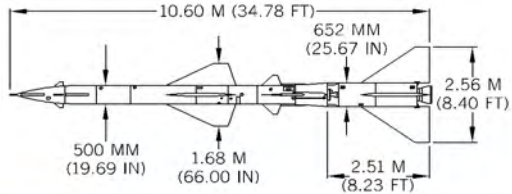

**U.S.S.R. GUIDED MISSILE, SURFACE-TO-AIR, SA-2B, SA-2C, SA-2F (GUIDELINE)**



N.E.W. 791.00 KG

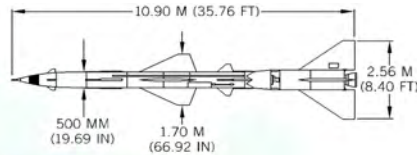

**U.S.S.R. GUIDED MISSILE, SURFACE-TO-AIR, SA-2D (GUIDELINE)**



N.E.W. 851.00 KG

**U.S. GUIDED MISSILES, SUBMARINE-TO-SURFACE,  
UGM-109C-1, -2 AND UGM-109D-1, -11, -2; -21  
(TOMAHAWK) (BLAST EFFECTS WARHEAD)**

Ordnance used with:  
RGM-109 WAREADS, CONVENTIONAL, (TOMAHAWK)  
MK 14 MOD 0, MISSILE CAN. SYS. (USED IN THE M...  
MK 1 MOD 0, CAPSULE SYSTEM, TTL  
WDU-25/B, WARHEAD, HE, MISSILE, (TOMAHAWK)  
WDU-36/B, WARHEAD, PENETRATOR, (FOR TOMAHAWK)  
MK 14 MOD 1, MISSILE CANISTERING SYS.

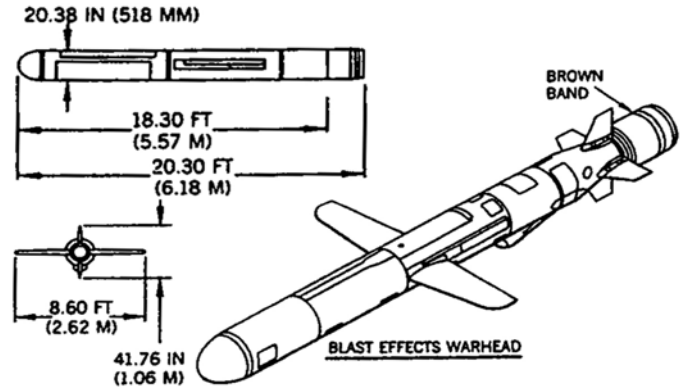

**U.S.S.R. GUIDED MISSILE, SURFACE-TO-AIR, SA-2E  
(GUIDELINE)**

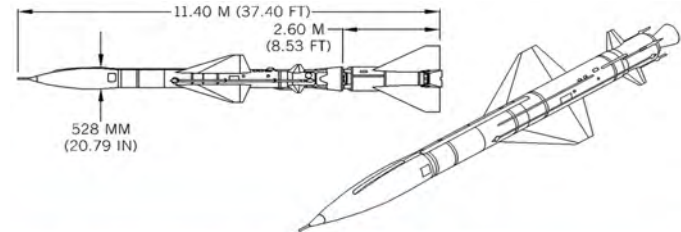



**U.S.S.R. GUIDED MISSILE, SURFACE-TO-AIR,  
SA-3/SA-N-1 (GOA) SERIES**

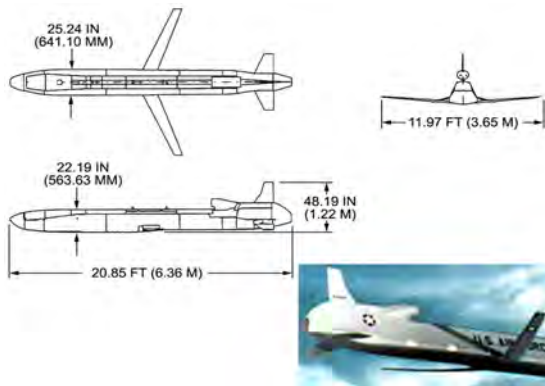

**U.S. GUIDED MISSILE, AIR-TO-SURFACE, AGM-86D  
(CALCM)**

Ordnance used with:  
A/A48K-1(V)2 COMMON STRATEGIC ROTARY LNCHR. (...)  
FMU-159A/B, BOMB, TAIL, HTSF  
FMU-159/B, BOMB, TAIL, HTSF  
AUP-3 (M), WARHEAD, 1,200 LB, HE-PENETRATION  
MAU-191/A, ARMING DEVICE  
UNDESIGNATED, FORWARD SECTION, F/ AGM-86D  
SWU-58/A, ROTARY SWITCH  
N.E.W. 47.50 KG

## U.S. GUIDED MISSILE, AIR-TO-SURFACE, CALCM, AGM-86C

Ordnance used with:

FMU-139A/B, NOSE & TAIL, IMPACT  
A/A48K-1(V)2 COMMON STRATEGIC ROTARY LNCHR. (...)  
MAU-191/A, ARMING DEVICE  
SWU-58/A, ROTARY SWITCH  
UNDESIGNATED, AFT SECTION, AGM-86 SERIES  
F107-WR-101, CALCM ENGINE  
FMU-137/A, IMPACT, GUIDED MISSILE (AGM-86C)  
N.E.W. 797.00 LB

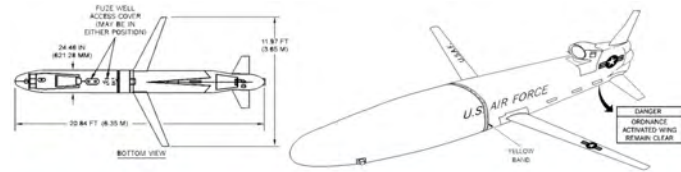

***THIS PAGE INTENTIONALLY LEFT BLANK***

**BULGARIAN CARTRIDGE, 73-MM, ROCKET, HEAT,  
PG-15V**

Ordnance used with:

PG-9, 73MM, HEAT

VP-9 G CH, ROCKET, PI ELEMENT

MDL. UNKNOWN, PG-9, 73MM, RKT MOTOR

PG-15P, 73MM, PROPELLING CHARGE

UNDESIGNATED, WARHEAD, 73MM, HEAT, FOR PG-9

VP-9 D CH, ROCKET, BD ELEMENT



---

**BULGARIAN CARTRIDGE, 73-MM, ROCKET, HEAT,  
PG-15VN**

Ordnance used with:

PG-9N, 73MM, HEAT

VP-9 G CH, ROCKET, PI ELEMENT

MDL. UNKNOWN, PG-9, 73MM, RKT MOTOR

PG-15P, 73MM, PROPELLING CHARGE

PG-9N, WARHEAD, 73-MM, HEAT

VP-9 D CH, ROCKET, BD ELEMENT



**BULGARIAN CARTRIDGE, 73-MM, ROCKET, HEAT,  
PG-9V**



Ordnance used with:  
PG-9, 73MM, HEAT  
VP-9 G CH, ROCKET, PI ELEMENT  
MDL. UNKNOWN, PG-9, 73MM, RKT MOTOR  
346 E, 73MM, PROPELLING CHARGE  
PG-9P, 73MM, EXPELLING CHARGE  
PG-9P, 73MM, PROPELLING CHARGE  
UNDESIGNATED, WARHEAD, 73MM, HEAT, FOR PG-9

---

**BULGARIAN CARTRIDGE, 73-MM, ROCKET, HEAT,  
PG-9VN**



Ordnance used with:  
PG-9N, 73MM, HEAT  
VP-9 G CH, ROCKET, PI ELEMENT  
MDL. UNKNOWN, PG-9, 73MM, RKT MOTOR  
346 E, 73MM, PROPELLING CHARGE  
PG-9P, 73MM, EXPELLING CHARGE  
PG-9P, 73MM, PROPELLING CHARGE  
PG-9N, WARHEAD, 73-MM, HEAT



## **BULGARIAN PROPELLING CHARGE, ROCKET CARTRIDGE, 73-MM, PG-15P**

Ordnance used with:

PG-15V, CARTRIDGE, 73MM, HEAT

PG-9, 73MM, HEAT

PG-15VN, CARTRIDGE, 73MM, HEAT

PG-9N, 73MM, HEAT

MDL. UNKNOWN, PG-9, 73MM, RKT MOTOR

PG-9, 73MM, PRACTICE

PG-15, CARTRIDGE, 73-MM, PRAC



---

## **BULGARIAN ROCKET, 73-MM, HEAT, PG-9N**

Ordnance used with:

PG-15VN, CARTRIDGE, 73MM, HEAT

VP-9 G CH, ROCKET, PI ELEMENT

MDL. UNKNOWN, PG-9, 73MM, RKT MOTOR

PG-9VN, 73MM, CARTRIDGE, ROCKET, HEAT

346 E, 73MM, PROPELLING CHARGE

PG-9P, 73MM, EXPELLING CHARGE

PG-9P, 73MM, PROPELLING CHARGE





**CHINESE ROCKET, 85MM, HEAT, TYPE 69-I W/TYPE 1 FUZE**

Ordnance used with:  
TYPE 1, ROCKET, PIBD



---

**BULGARIAN ROCKET EXPPELLING CHARGE, PG-7P**



Ordnance used with:  
PG-7VL, 93MM, HEAT-T



## CHINESE EXPELLING CHARGE, MODEL UNKNOWN (FOR PG-9 TYPE)

Ordnance used with:  
TYPE 69-1, 85-MM, HEAT  
TYPE 69-1, 85MM, HEAT



---

## U.S.S.R. ROCKET WARHEAD, 57-MM, HE-FRAG, S-5MO

Ordnance used with:  
UB-16-57, UMVP, LAUNCHER, ROCKET, AIRCRAFT  
UB-32A1, LAUNCHER, ROCKET, AIRCRAFT (57-MM)  
V-5K, ROCKET, PD, A-TO-S  
C-5MO, 57-MM, HE/FRAG, A-TO-S  
S-5MO, 57-MM, HE/FRAG, A-TO-S  
S-5MO, MOTOR, 57 MM, SOLID PROPELLENT, A-TO-S

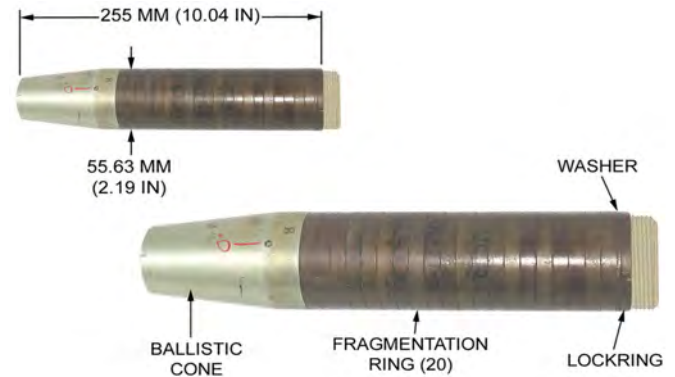



### U.S.S.R. ROCKET MOTOR, 57-MM, SOLID PROPELLANT, AIR-TO-SURFACE, S-5KO

Ordnance used with:  
UB-16-57, UMVP, LAUNCHER, ROCKET, AIRCRAFT  
UB-32A1, LAUNCHER, ROCKET, AIRCRAFT (57-MM)  
S-5KO, 57-MM, WARHEAD, HEAT-FRAG, A-TO-S

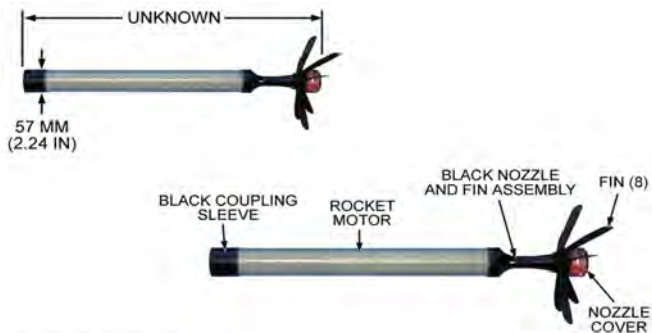

### U.S.S.R. ROCKET MOTOR, 57-MM, SOLID PROPELLANT, MODEL UNKNOWN

Ordnance used with:  
S-5-OB, 57-MM, WARHEAD, ILLUMINATION, A-TO-S  
S-5-01, 57-MM, ILLUMINATION, A-TO-S  
S-5-OB, 57-MM, ILLUMINATION, A-TO-S

"Image from the Russian Arms Catalog,  
Vol. VII, reproduced with permission from  
Military Parade Publishing House."

## U.S.S.R. ROCKET MOTOR, 57-MM, SOLID PROPELLANT, S-5KP

Ordnance used with:

UB-16-57, UMVP, LAUNCHER, ROCKET, AIRCRAFT  
UB-32A1, LAUNCHER, ROCKET, AIRCRAFT (57-MM)  
S-5KP, 57-MM, HEAT/FRAG, A-TO-S  
S-5KP, 57-MM, WARHEAD, HEAT/FRAG, A-TO-S



## U.S.S.R. ROCKET MOTOR, 57-MM, SOLID-PROPELLANT, S-5MO

Ordnance used with:

UB-16-57, UMVP, LAUNCHER, ROCKET, AIRCRAFT  
UB-32A1, LAUNCHER, ROCKET, AIRCRAFT (57-MM)  
C-5MO, 57-MM, HE/FRAG, A-TO-S  
S-5MO, 57-MM, HE/FRAG, A-TO-S  
S-5MO, 57-MM, WARHEAD, HEAT/FRAG, A-TO-S

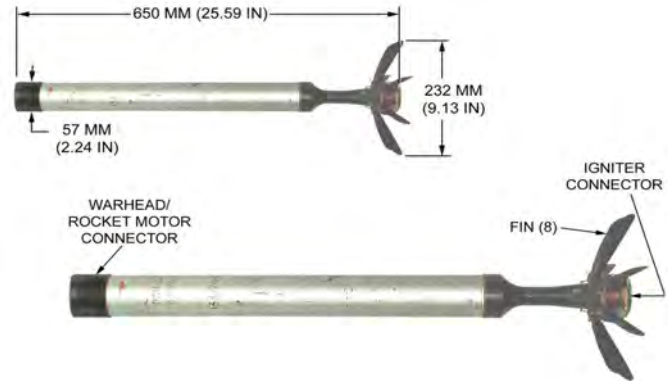

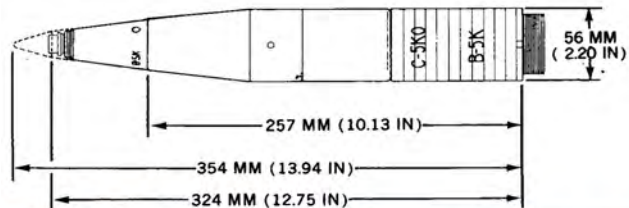

## U.S.S.R. ROCKET WARHEAD, 57-MM, HEAT/FRAG MODEL S-5KO

Ordnance used with:  
 UB-16-57, UMVP, LAUNCHER, ROCKET, AIRCRAFT  
 UB-32A1, LAUNCHER, ROCKET, AIRCRAFT (57-MM)  
 V-5K, ROCKET, PD, A-TO-S  
 V-5M1, ROCKET, PDSD  
 KO-7V, 57MM, CARTRIDGE, HEAT-FRAG

## U.S.S.R. ROCKET WARHEAD, 57-MM, HEAT/FRAG, S-5KP



Ordnance used with:  
 UB-16-57, UMVP, LAUNCHER, ROCKET, AIRCRAFT  
 UB-32A1, LAUNCHER, ROCKET, AIRCRAFT (57-MM)  
 S-5KP, 57-MM, HEAT/FRAG, A-TO-S  
 S-5KP, MOTOR, 57-MM, SOLID PROPELLANT, A-TO-S  
 V-5KP1, ROCKET, PIBD, A-TO-S

## U.S.S.R. ROCKET, 57-MM, AIR-TO-SURFACE, HEAT/ FRAG, S-5KP

Ordnance used with:

UB-16-57, UMVP, LAUNCHER, ROCKET, AIRCRAFT  
UB-32A1, LAUNCHER, ROCKET, AIRCRAFT (57-MM)  
UB-32A, LAUNCHER, ROCKET, AIRCRAFT (57-MM)  
S-5KP, 57-MM, WARHEAD, HEAT/FRAG, A-TO-S  
S-5KP, MOTOR, 57-MM, SOLID PROPELLANT, A-TO-S  
V-5KP1, ROCKET, PIBD, A-TO-S



## U.S.S.R. ROCKET, 57-MM, CHAFF, S-5PB

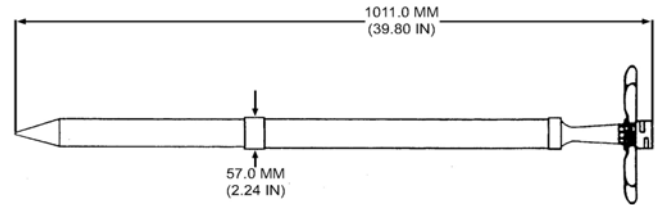



## U.S.S.R. ROCKET, 57-MM, HE, S-5M

Ordnance used with:  
UB-16-57, UMVP, LAUNCHER, ROCKET, AIRCRAFT  
UB-32A1, LAUNCHER, ROCKET, AIRCRAFT (57-MM)  
UB-32A, LAUNCHER, ROCKET, AIRCRAFT (57-MM)  
UB-16-57-U, 57-MM, LAUNCHER, RKT  
V-5M1, ROCKET, PDSD  
UB-16-57-U, 57 MM, LAUNCHER, ROCKET, 16 SHOT

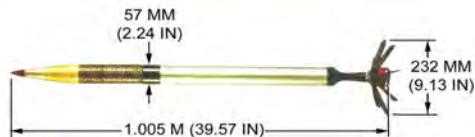

## U.S.S.R. ROCKET, 57-MM, HE-FRAG, S-5MO

Ordnance used with:  
UB-16-57, UMVP, LAUNCHER, ROCKET, AIRCRAFT  
UB-32A1, LAUNCHER, ROCKET, AIRCRAFT (57-MM)  
V-5K, ROCKET, PD, A-TO-S  
V-5M1, ROCKET, PDSD  
S-5MO, 57-MM, WARHEAD, HEAT/FRAG, A-TO-S  
S-5MO, MOTOR, 57 MM, SOLID PROPELLENT, A-TO-S

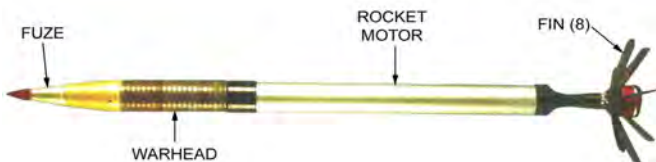



## U.S.S.R. ROCKET, 57-MM, HEAT/FRAG, S-5KPB

Ordnance used with:  
UB-16-57, UMVP, LAUNCHER, ROCKET, AIRCRAFT  
UB-32A1, LAUNCHER, ROCKET, AIRCRAFT (57-MM)  
V-5KP1, ROCKET, PIBD, A-TO-S

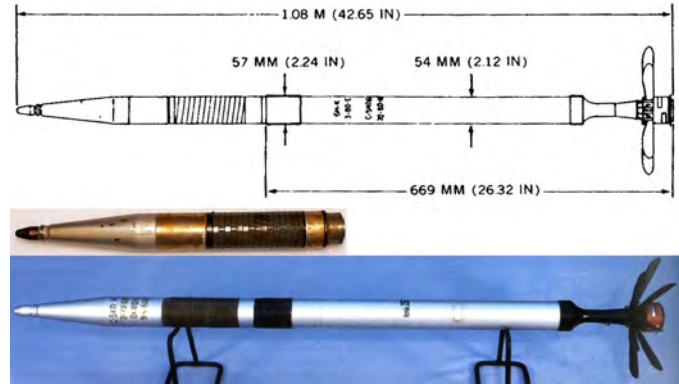

## U.S.S.R. ROCKET, 57-MM, ILLUMINATION, S-5-OB

Ordnance used with:  
S-5-OB, 57-MM, WARHEAD, ILLUMINATION, A-TO-S  
VB-5, ROCKET, NOSE, A-TO-S  
S-5-OB, MOTOR, 57-MM, SOLID PROPELLANT, AIR-S...

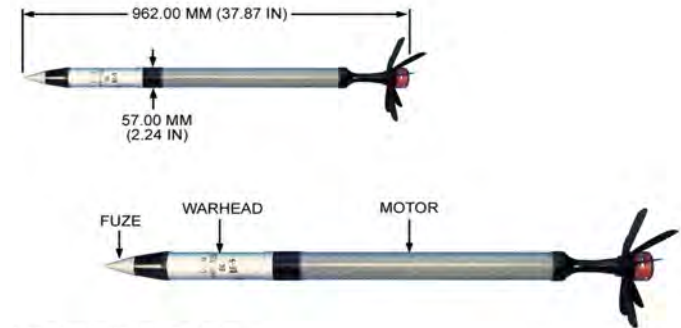

"Image from the Russian Arms Catalog,  
Vol. VII, reproduced with permission from  
Military Parade Publishing House."

## U.S.S.R. ROCKETS, 57-MM, HEAT, S-5K AND S-5K1



Ordnance used with:  
UB-16-57-U, 57-MM, LAUNCHER, RKT  
V-5K, ROCKET, PD, A-TO-S  
MP-4, PROJECTILE, PD  
UB-16-57-U, 57 MM, LAUNCHER, ROCKET, 16 SHOT

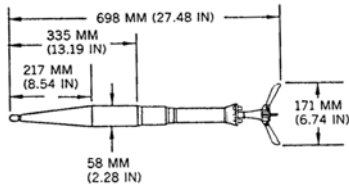

## U.S.S.R. GRENADE, 58-MM, ROCKET-PROPELLED, HEAT-FS-T, PG-16

Ordnance used with:  
VP-16 G CH, ROCKET, PIBD, PI ELEMENT  
PG-16P, 57MM, EXPPELLING CHARGE, RKT  
VP-9 D CH, ROCKET, PIBD, BASE DETONATING ELEMENT  
PG-16V, 58MM, CARTRIDGE, HEAT



N.E.W. 800.00 G

## YUGOSLAV ROCKET, 64-MM, HEAT, M80

Ordnance used with:  
RBR M80, 64-MM, RKT SYSTEM, HEAT



## U.S. ROCKET WARHEAD, 2.75-IN, HE, M261

Ordnance used with:  
LAU-130/A, LAUNCHER, RKT  
LAU-131/A, LAUNCHER, RKT  
LAU-3/A, LAUNCHER, RKT  
LAU-32/A, LAUNCHER, RKT  
LAU-32A/A, LAUNCHER, RKT  
LAU-3A/A, LAUNCHER, RKT  
LAU-3B/A, LAUNCHER, RKT  
N.E.W. 34.18 OZ

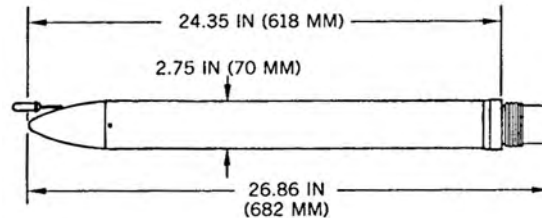



## U.S.S.R. ROCKET, 70-MM, HEAT, PG-7M

Ordnance used with:  
VP-7M, ROCKET, PIBD  
PG-7VM, 70MM, CARTRIDGE, HEAT  
PG-7VM, 70MM, CARTRIDGE, HEAT

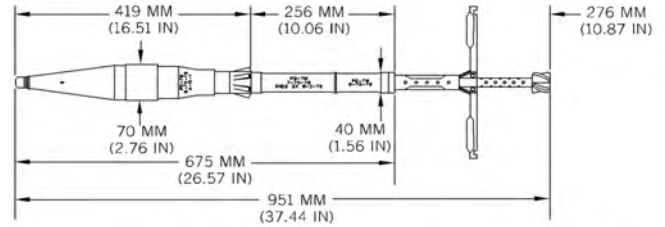

N.E.W. 489.00 G

## U.S.S.R. ROCKET, 70-MM, GROUND-TO-GROUND, HEAT, PG-7S

Ordnance used with:  
PG-7P, EJECTION CHARGE FOR PG-7-SERIES ROCKETS  
VP-7M G CH, FUZE, ROCKET, PI ELEMENT  
VP-7M D CH, FUZE, ROCKET, BASE DETONATING ELEMENT



## BULGARIAN CARTRIDGE, 73-MM, ROCKET, PRACTICE, PG-15



Ordnance used with:  
MDL. UNKNOWN, PG-9, 73MM, RKT MOTOR  
PG-9, 73MM, PRACTICE  
PG-15P, 73MM, PROPELLING CHARGE  
PG-9, WARHEAD, 73-MM, PRAC



## BULGARIAN ROCKET, 73-MM, HEAT, PG-9



Ordnance used with:  
PG-15V, CARTRIDGE, 73MM, HEAT  
VP-9 G CH, ROCKET, PI ELEMENT  
PG-9V, 73MM, CARTRIDGE, ROCKET, HEAT  
MDL. UNKNOWN, PG-9, 73MM, RKT MOTOR  
346 E, 73MM, PROPELLING CHARGE  
PG-9P, 73MM, EXPELLING CHARGE  
PG-9P, 73MM, PROPELLING CHARGE

## **BULGARIAN WARHEAD, 73-MM, ROCKET, HEAT, PG-9N**

Ordnance used with:

PG-15VN, CARTRIDGE, 73MM, HEAT

PG-9N, 73MM, HEAT

VP-9 G CH, ROCKET, PI ELEMENT

MDL. UNKNOWN, PG-9, 73MM, RKT MOTOR

PG-9VN, 73MM, CARTRIDGE, ROCKET, HEAT

346 E, 73MM, PROPELLING CHARGE

PG-9P, 73MM, EXPELLING CHARGE



---

## **BULGARIAN WARHEAD, 73MM, ROCKET, HEAT, PG-9**

Ordnance used with:

PG-15V, CARTRIDGE, 73MM, HEAT

PG-9, 73MM, HEAT

VP-9 G CH, ROCKET, PI ELEMENT

PG-9V, 73MM, CARTRIDGE, ROCKET, HEAT

MDL. UNKNOWN, PG-9, 73MM, RKT MOTOR

VP-9 D CH, ROCKET, BD ELEMENT



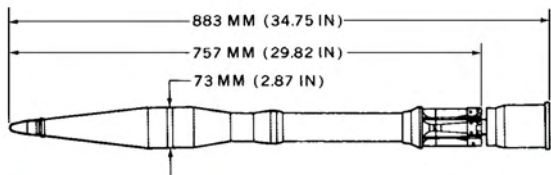

## U.S.S.R. CARTRIDGE, 73-MM, HEAT-T, PG-9, PG-9S & PG-9 PRACTICE

Ordnance used with:  
 PG-15, CARTRIDGE, 73-MM, HEAT-T  
 VP-9, ROCKET, PIBD

N.E.W. 335.00 G



## BULGARIAN ROCKET MOTOR, 73-MM, PG-9

Ordnance used with:  
 PG-15V, CARTRIDGE, 73MM, HEAT  
 PG-9, 73MM, HEAT  
 PG-15VN, CARTRIDGE, 73MM, HEAT  
 PG-9N, 73MM, HEAT  
 PG-9V, 73MM, CARTRIDGE, ROCKET, HEAT  
 PG-9VN, 73MM, CARTRIDGE, ROCKET, HEAT  
 346 E, 73MM, PROPELLING CHARGE

N.E.W. 495.00 G



## CHINESE ROCKET, 75-MM, APERS, BOUNDING, TYPE 69

Ordnance used with:  
MJ-7, FUZE, ROCKET, PI  
DREOI, FUZE, ROCKET, PI

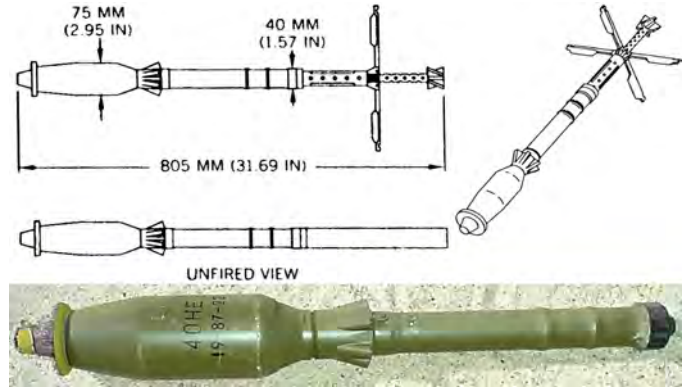

## U.S.S.R. ROCKET MOTOR, 80-MM, SOLID PROPELLANT, S-8-OF

Ordnance used with:  
S-8-OF, 80-MM, HE/FRAG, A-TO-S  
V-8, ROCKET, PD, A-TO-S  
S-8-OF, WARHEAD, 80-MM, HE/FRAG, A-TO-S

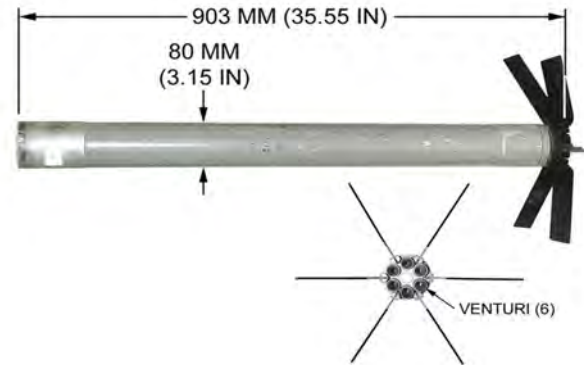

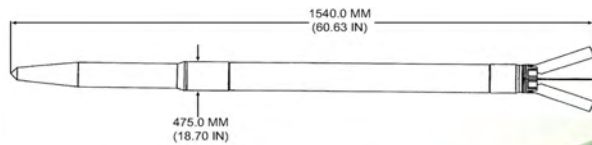

**U.S.S.R. ROCKET, 80-MM, APHE, S8BM**



**U.S.S.R. ROCKET, 80-MM, CHAFF, S8PM**

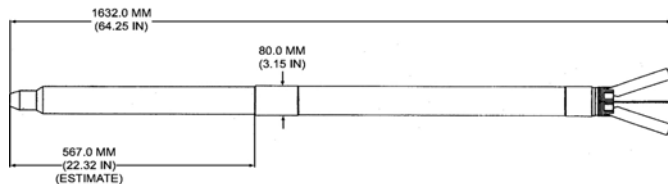

## U.S.S.R. ROCKET, 80-MM, FAE, S8DM

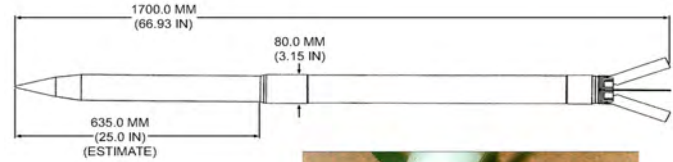

## U.S.S.R. ROCKET, 80-MM, FLECHETTE, S8ASM

Ordnance used with:

- B-8M, LAUNCHER, ROCKET, 20-SHOT
- B-8M1, LAUNCHER, ROCKET, 20-SHOT
- B-8V20-A, LAUNCHER, ROCKET, 20-SHOT
- B-8V20A, LAUNCHER, ROCKET, 20-SHOT
- B-8V7, LAUNCHER, 7-SHOT

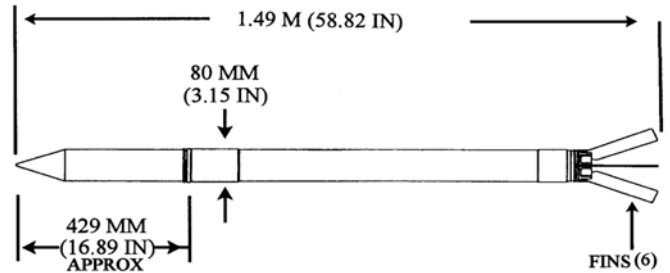

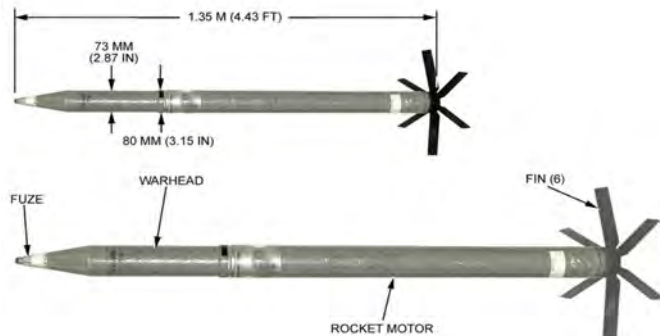

## U.S.S.R. ROCKET, 80-MM, HE/FRAG, S-8-OF

Ordnance used with:  
 V-8, ROCKET, PD, A-TO-S  
 S-8-OF, WARHEAD, 80-MM, HE/FRAG, A-TO-S  
 S-8-OF, 80-MM, MOTOR, SOLID PROPELLANT, A-TO-S

N.E.W. 10.04 KG

## U.S.S.R. ROCKET, 80-MM, ILLUMINATION, S80M

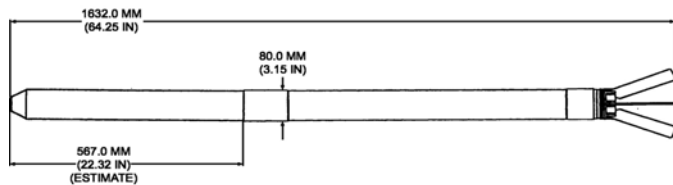

## U.S.S.R. WARHEAD, 80-MM, HE/FRAG, S-8-OF

Ordnance used with:  
S-8-OF, 80-MM, HE/FRAG, A-TO-S  
V-8, ROCKET, PD, A-TO-S  
S-8-OF, 80-MM, MOTOR, SOLID PROPELLANT, A-TO-S



N.E.W. 1.37 KG

## YUGOSLAV ROCKET SYSTEM, 64-MM, HEAT, RBR M80

Ordnance used with:  
M80, 64MM, HEAT

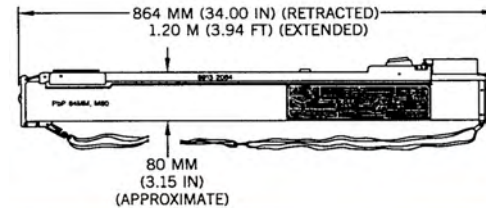

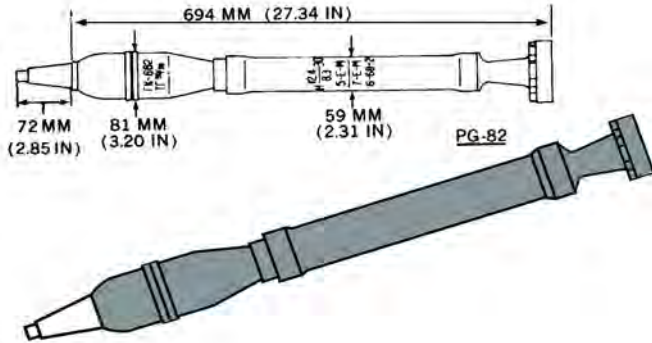

## U.S.S.R. ROCKET, 82 MM, HE, OG82

Ordnance used with:

- GK-1, FUZE, PROJECTILE, PD
- GK-2, FUZE, PROJECTILE, PD
- GK-2M, FUZE, PROJECTILE, PD
- GK-662, 82 MM, WARHEAD, HEAT

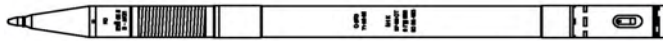

## U.S.S.R. ROCKET, 80-MM, HEAT/FRAG, S-8KO

Ordnance used with:

- 9-K1-608, ROCKET, BASE ELEMENT, A-TO-S
- B-8M, LAUNCHER, ROCKET, 20-SHOT
- B-8M1, LAUNCHER, ROCKET, 20-SHOT
- B-8V20-A, LAUNCHER, ROCKET, 20-SHOT
- B-8V20A, LAUNCHER, ROCKET, 20-SHOT
- B-8V7, LAUNCHER, 7-SHOT
- V-5KP1, ROCKET, PIBD, A-TO-S

N.E.W. 1.00 KG



## U.S.S.R. ROCKET, 80-MM, HEAT/FRAG, S-8KOM

Ordnance used with:

9-K1-608, ROCKET, BASE ELEMENT, A-TO-S  
B-8M, LAUNCHER, ROCKET, 20-SHOT  
B-8M1, LAUNCHER, ROCKET, 20-SHOT  
B-8V20-A, LAUNCHER, ROCKET, 20-SHOT  
B-8V20A, LAUNCHER, ROCKET, 20-SHOT  
B-8V7, LAUNCHER, 7-SHOT  
V-5KP1, ROCKET, PIBD, A-TO-S

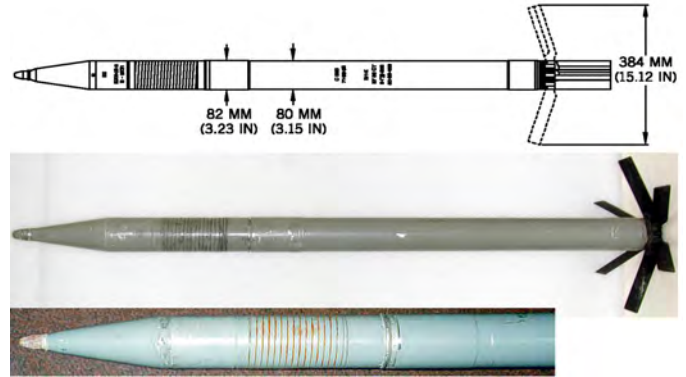

## BULGARIAN ROCKET, 85-MM, HEAT, PG7

Ordnance used with:

VP-7M, ROCKET, PIBD  
PG-7P, EJECTION CHARGE FOR PG-7-SERIES ROCKETS  
VP-7M D CH, FUZE, ROCKET, BASE DETONATING ELEMENT  
VP-7M G CH, FUZE, ROCKET, PI ELEMENT  
PG-7, RKT MOTOR

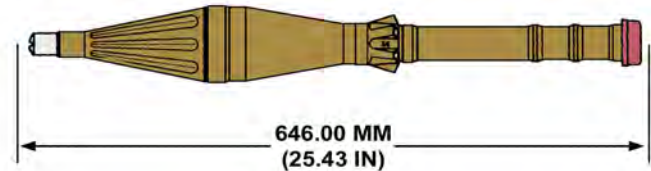

N.E.W. 603.44 G



## CHINESE ROCKET, 85-MM, HEAT, TYPE 69-1

Ordnance used with:  
MDL UNKNOWN, EXPPELLING CHARGE FOR TYPE 69-1  
FUZE, ROCKET, PIBD, TYPE 69-1

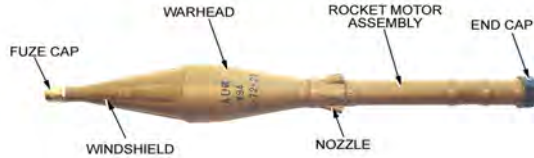

## IRANIAN ROCKET, HEAT-T, NADER



## PAKISTANI ROCKET, 85MM, HEAT, P1 MK1



---

## U.S.S.R. ROCKET, 85-MM, HEAT, PG-7

Ordnance used with:  
VP-7, ROCKET, PIBD  
PG-7P, EJECTION CHARGE FOR PG-7-SERIES ROCKETS





## U.S.S.R. ROCKET, 85-MM, HEAT-T, MODEL PG-7G

Ordnance used with:  
UNDESIGNATED, GRENADE, PIBD

N.E.W. 770.00 G

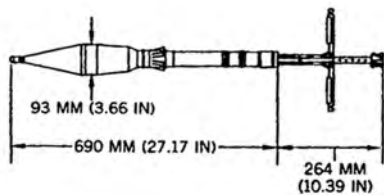

## U.S.S.R. GRENADE, 93-MM, HEAT-T, ROCKET PROPELLED, PG-7VL

Ordnance used with:  
PG-7L, 94MM, HEAT  
PG-7P, EXPPELLING CHARGE



## CHINESE ROCKET, 107-MM, HE, TYPE 63-2

Ordnance used with:  
MJ-1, ROCKET, PD

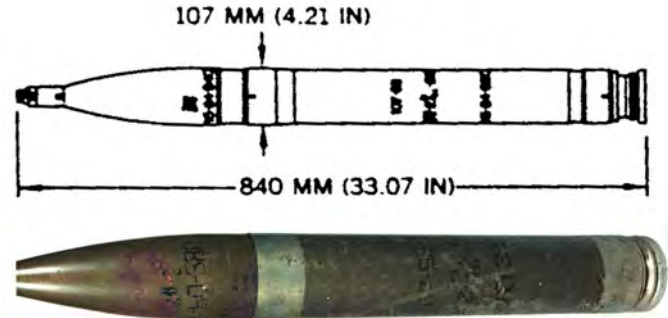

N.E.W. 1.30 KG

## CHINESE ROCKET, 107-MM, HE-FRAG, SPIN-STABILIZED, TYPE 63

Ordnance used with:  
MD-21, ROCKET, PROX.  
TYPE 1, ROCKET, PD

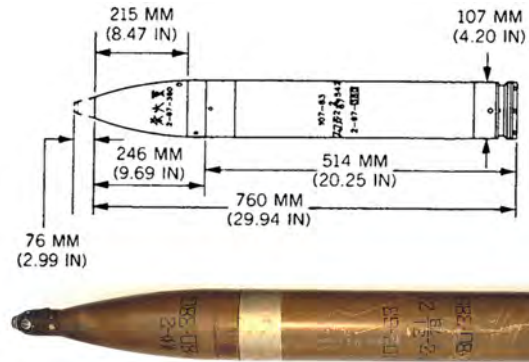

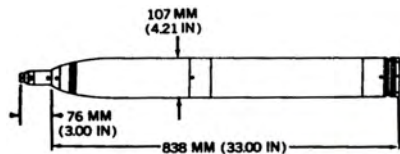

## CHINESE ROCKET, 107-MM, INCENDIARY, TYPE 63-1

Ordnance used with:  
MD-21, ROCKET, PROX.  
MJ-1, ROCKET, PD  
TYPE 63-1, WARHEAD, 107 MM, INCENDIARY

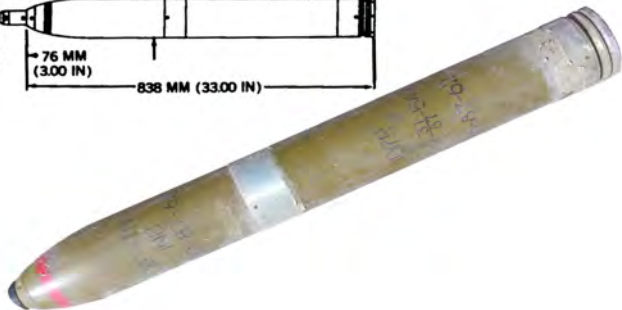

---

## NORTH KOREAN ROCKET, 107MM, HE, R107

Ordnance used with:  
TYPE 107, ROCKET, PD  
MDL. UNKNOWN, ROCKET, FOR R107



**U.S.S.R. ROCKET, 122-MM, AIR-TO-SURFACE, HE,  
S-13D**

Ordnance used with:  
B-13L, LAUNCHER, ROCKET, 5 SHOT

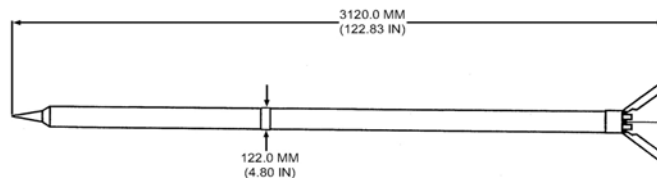

---

**U.S.S.R. ROCKET, 122-MM, HE, 9M28F**

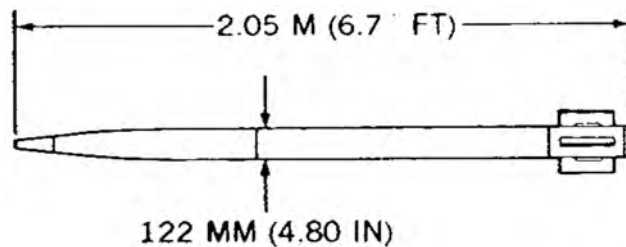

N.E.W. 6.00 KG

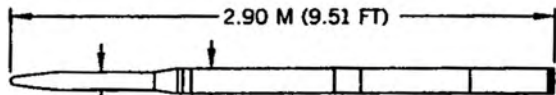

90 MM  
(3.54 IN)    122 MM  
(4.80 IN)

**U.S.S.R. ROCKET, 122-MM, HE, S-13**

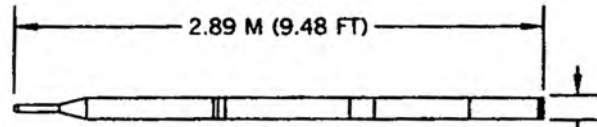

122 MM  
(4.80 IN)

**U.S.S.R. ROCKET, 122-MM, HE, S-13-OF**

Ordnance used with:  
B-13L, LAUNCHER, ROCKET, 5 SHOT



N.E.W. 7.00 KG

## U.S.S.R. ROCKET, 122-MM, HE, S-13-T

Ordnance used with:  
B-13L, LAUNCHER, ROCKET, 5 SHOT

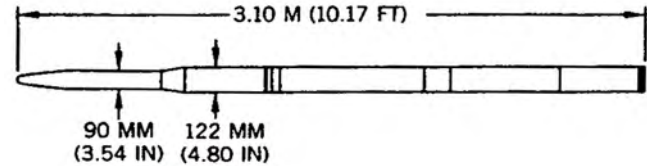

N.E.W. 4.50 KG

## U.S.S.R. ROCKET, 122-MM, HE-FRAG, FIN & SPIN-STABILIZED, 9M22U (9-FOOT)

Ordnance used with:  
MRV-U, ROCKET, PD  
9E210, ROCKET, PD  
M-210F, WARHEAD, 122-MM, HE-FRAG  
M-210FM, RKT WARHEAD, 122-MM, HE-FRAG  
MRV-U, ROCKET, PD

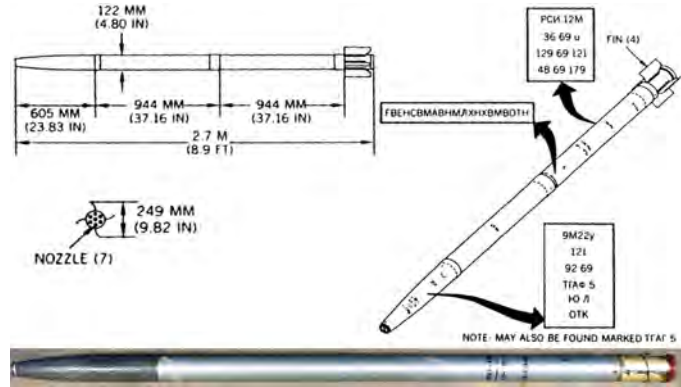



## U.S.S.R. ROCKET, 122-MM, HE-FRAG, FIN- & SPIN-STABILIZED, 9M22M (6-FOOT)

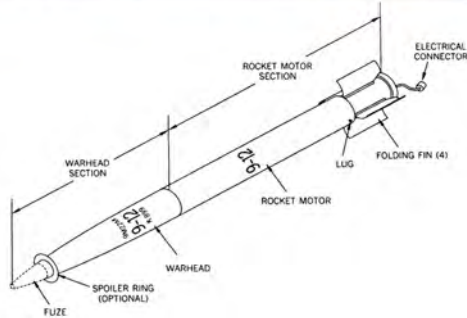

Ordnance used with:  
 DKZ-B, ROCKET, NOSE, PD  
 MRV, RKT FUZE, PD  
 MRV-42M, ROCKET, PD  
 MRV-U, ROCKET, PD  
 M-210F, WARHEAD, 122-MM, HE-FRAG  
 M-210FM, RKT WARHEAD, 122-MM, HE-FRAG  
 MRV-U, ROCKET, PD

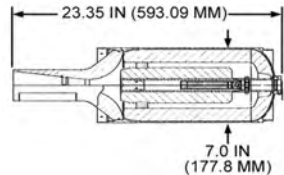

## U.S. GUIDED MISSILE ROCKET MOTOR, M120E4



Ordnance used with:  
 AGM-114K, GUIDED MISSILE, A-TO-S (HELLFIRE II)  
 AGM-114L, GUIDED MISSILE, A-TO-S (LONGBOW)  
 AGM-114M, GUIDED MISSILE, AIR-TO-SURFACE, HEL...  
 AGM-114N, GUIDED MISSILE, HELFIRE II

N.E.W. 21.96 LB



## U.S.S.R. ROCKET, 64-MM, HEAT, MODEL PG-18

Ordnance used with:  
V659, ROCKET, BD  
VP-18 D CH, ROCKET, BD ELEMENT

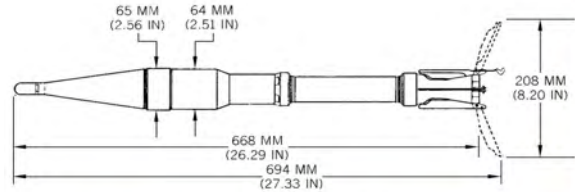

## U.S.S.R. ROCKET WARHEAD, 220-MM, AT, MINE DISPENSING, 9N128K2

Ordnance used with:  
9M27K2, 220 MM, CARGO  
PGMDM, LANDMINE, AT  
PTM-1, LANDMINE, AT  
PTM-1S, LANDMINE, AT



"Image from Russian Arms Catalog, Vol. 7, reproduced with Permission from Military Parade Publishing House."

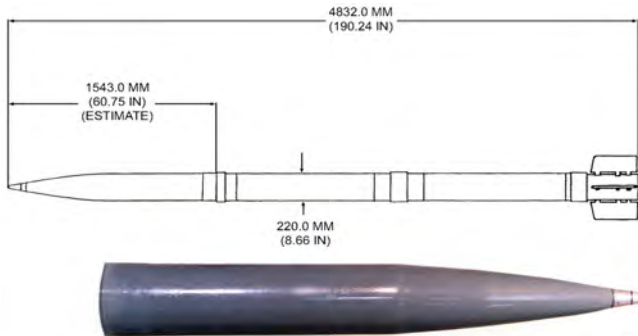

"Image from Russian Arms Catalog, Vol. 7, reproduced with Permission from Military Parade Publishing House."

## U.S.S.R. ROCKET WARHEAD, 220-MM, HE, 9N128F

Ordnance used with:  
MRV-U, ROCKET, PD  
9M27F, 220MM, HE  
MRV-U, ROCKET, PD

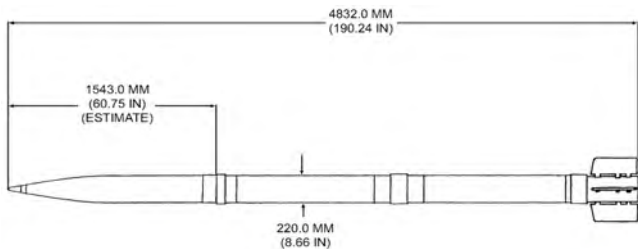

## U.S.S.R. ROCKET, 220-MM, HE, 9M27F

Ordnance used with:  
MRV-U, ROCKET, PD  
9N128F, WARHEAD, 220MM, HE  
MRV-U, ROCKET, PD



## U.S.S.R. ROCKET, 220-MM, HE, 9M27K1

Ordnance used with:  
9N128K1, WARHEAD, 220MM, CARGO

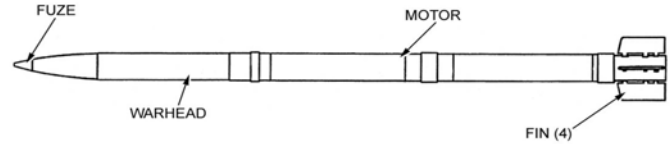

---

## U.S.S.R. ROCKET, SURFACE-TO-SURFACE, 220-MM, AT, MINE DISPENSING, 9M27K2

Ordnance used with:  
PGMDM, LANDMINE, AT  
PTM-1, LANDMINE, AT  
PTM-1S, LANDMINE, AT  
9N128K2, WARHEAD, 220MM, CARGO

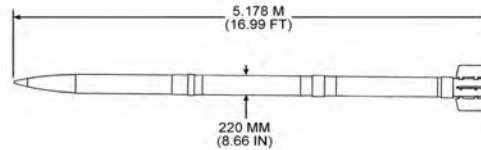

## U.S.S.R. ROCKET, SURFACE-TO-SURFACE, APERS, MINE DISPENSING, 9M27K3

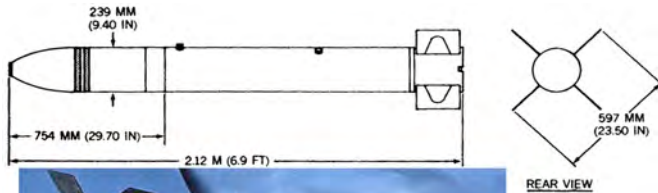
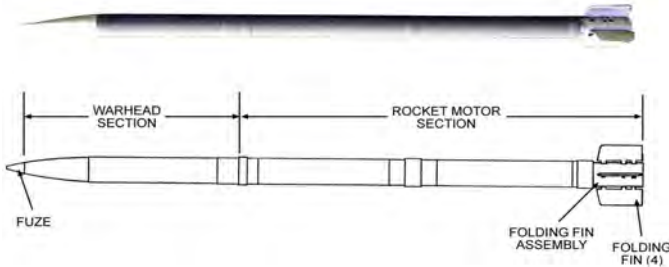

## U.S.S.R. ROCKET, 240-MM, AIRCRAFT, HE, MODEL S-24

Ordnance used with:  
V-24A, PD, RKT  
9-A-682, ROCKET, PROXIMITY, A-TO-S  
RV-24, ROCKET, PROXIMITY, A-TO-S



# BULGARIAN PROPELLING CHARGE, 73-MM, PG-9P

- Ordnance used with:
- PG-9, 73MM, HEAT
- PG-9N, 73MM, HEAT
- 346-E, 73MM, CARTRIDGE, HE (TEARDROP)
- 346E, 73MM, CARTRIDGE, HE (TEARDROP)
- OG-9, 73MM, CARTRIDGE, HE (TEARDROP)
- OG-9/F, 73MM, CARTRIDGE, HE (TEARDROP)
- PG-9V, 73MM, CARTRIDGE, ROCKET, HEAT

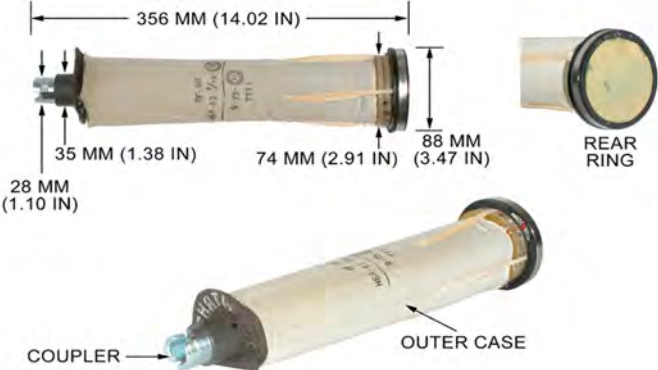

***THIS PAGE INTENTIONALLY LEFT BLANK***

**FRENCH GRENADE, RIFLE, 40-MM, APERS/  
ANTIVEHICLE, BTRG AP/AV (AP-AV-F2)**

Ordnance used with:  
UNKNOWN, GRENADE, BD

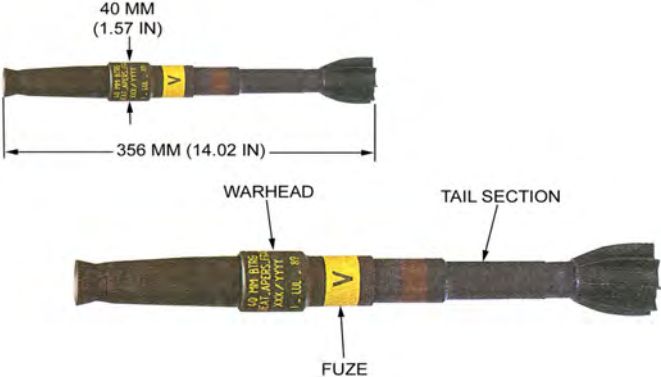

N.E.W. 63.00 G

**CHINESE GRENADE, HAND, FRAG, TYPE 73**

Ordnance used with:  
UNKNOWN, GRENADE, ALL-WAY ACTING

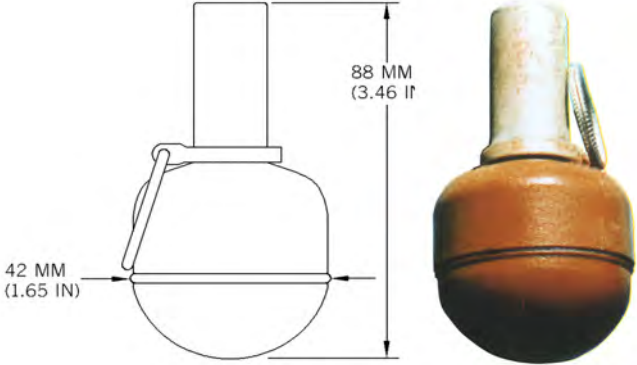

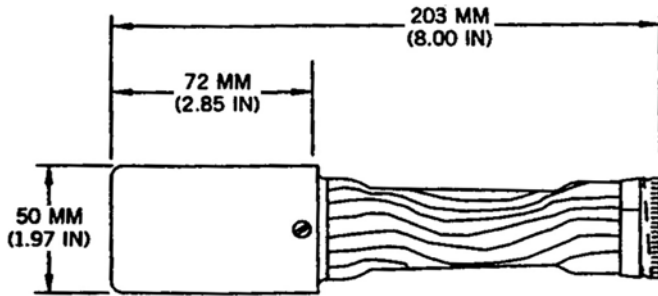

**CHINESE GRENADE, HAND, STICK, FRAG,  
NONSERRATED SHORT CYLINDRICAL BODY A**

**NONSERRATED SHORT  
CYLINDRICAL HEAD (A)**

N.E.W. 26.00 G



**CHINESE GRENADE, HAND, STICK, FRAG, M46**

N.E.W. 49.00 G





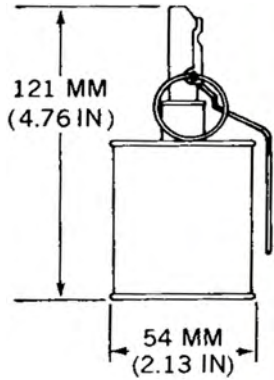

## U.S.S.R. GRENADE, HAND, DEFENSIVE, RG-42

Ordnance used with:  
UZRG, GRENADE, STRIKER-RELEASE  
UZRGM, GRENADE, STRIKER-RELEASE  
FGM-1, GRENADE, STRIKER-RELEASE

N.E.W. 120.00 G



## RUSSIAN GRENADE, HAND, PRACTICE, URG

Ordnance used with:  
UNKNOWN, GRENADE, STRIKER-RELEASE, PRACTICE

## U.S.S.R. GRENADE, HAND, DEFENSIVE, F-1; ROMANIAN GRENADE, TIP F-1

Ordnance used with:  
F-IN-60, 55MM, RIFLE, FRAG  
UZRG, GRENADE, STRIKER-RELEASE  
UZRGM, GRENADE, STRIKER-RELEASE  
UZRGM-2, GRENADE, HAND, STRIKER-RELEASE  
(UZRGM COPY)  
UNKNOWN, GRENADE, STRIKER-RELEASE  
(UZRGM COPY)

N.E.W. 54.00 G

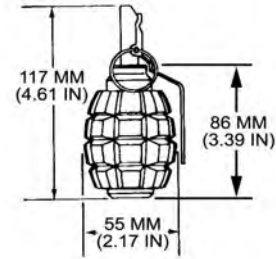

## U.K. GRENADE, HAND/RIFLE, APERS, HE-FRAG, L2A1

Ordnance used with:  
L25A2, GRENADE, STRIKER-RELEASE  
L25A1, GRENADE, STRIKER-RELEASE  
L25A3, GRENADE, STRIKER-RELEASE  
L25A4, GRENADE, STRIKER-RELEASE  
L25A5, GRENADE, STRIKER-RELEASE  
L25A6, GRENADE, STRIKER-RELEASE  
L1A1, 56MM, ADAPTER, PROJECTION, GRENADE, RIFLE

N.E.W. 170.00 G

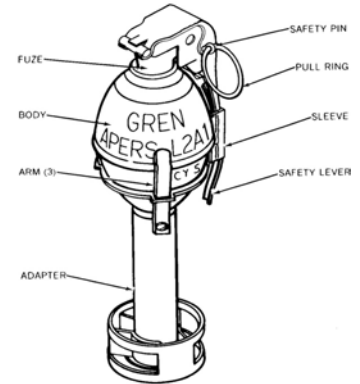
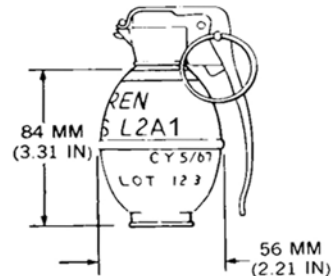

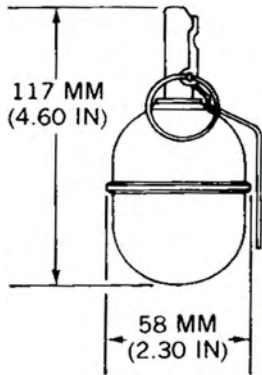

## U.S.S.R. GRENADE, HAND, DEFENSIVE, RGD-5

Ordnance used with:  
DVM, GRENADE, STRIKER-RELEASE  
DVM-78, GRENADE, STRIKER-RELEASE  
UZRG, GRENADE, STRIKER-RELEASE  
UZRGM, GRENADE, STRIKER-RELEASE  
UZRGM-2, GRENADE, HAND, STRIKER-RELEASE

N.E.W. 111.00 G

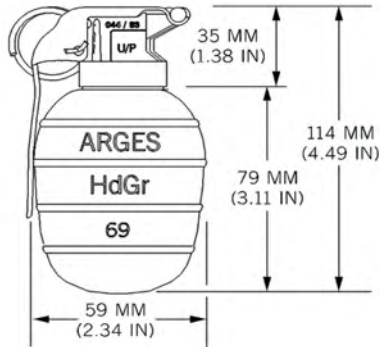

## AUSTRIAN GRENADE, HAND, FRAGMENTATION, HG 69; PAKISTANI P-1 MK 1

Ordnance used with:  
P7 MK 1, LANDMINE, APERS, JUMPING

N.E.W. 62.00 G

## U.S.S.R. GRENADE, HAND, FRAG, RGN

Ordnance used with:  
UDZ, GRENADE, STRKR-RELEASE, ALL-WAY ACTING, ...  
UDZ-S, GRENADE, STRKR-RELEAS, ALL-WAY ACTING...

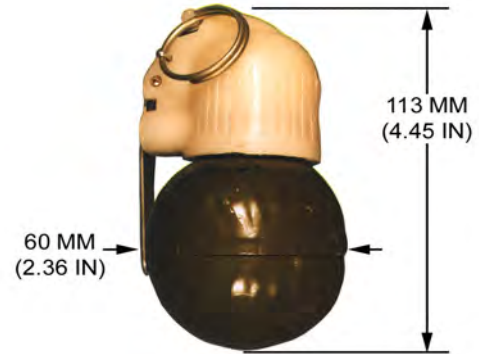

N.E.W. 114.00 G

---

## U.S.S.R. GRENADE, HAND, FRAG, RGO

Ordnance used with:  
UDZ, GRENADE, STRKR-RELEASE, ALL-WAY ACTING, ...  
UDZ-S, GRENADE, STRKR-RELEAS, ALL-WAY ACTING...

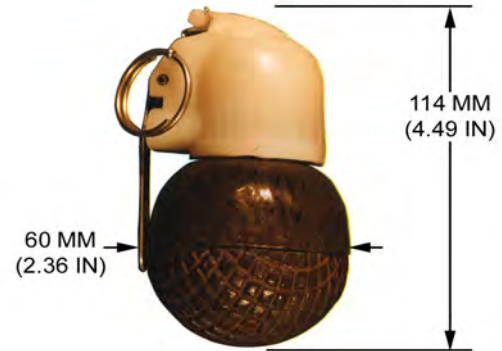

N.E.W. 92.00 G

---

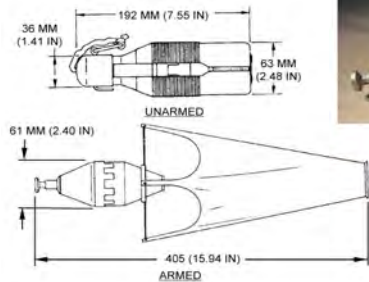

**EGYPTIAN GRENADE, HAND, HEAT, TYPE 2 (HOSAM)**

N.E.W. 143.00 G

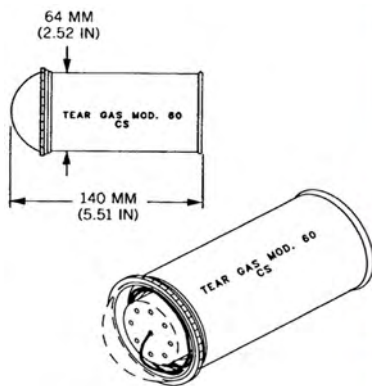

**ITALIAN GRENADES, HAND, SMOKE, M60F; AND CN-CS, M60L**

## U.S. GRENADE, HAND, FRAG, M67

Ordnance used with:  
M213, GRENADE, STRIKER-RELEASE

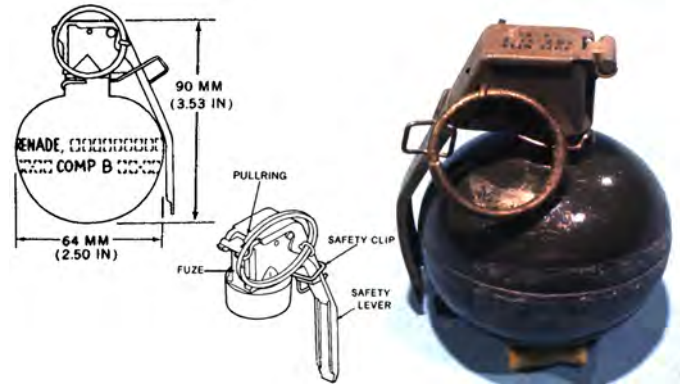

N.E.W. 184.00 G

## U.S. GRENADE, HAND, INCENDIARY, AN-M14

Ordnance used with:  
M201A1E2, GRENADE, STRIKER-RELEASE  
M201A1, GRENADE, STRIKER-RELEASE  
AN-M14, HAND, BODY, INCENDIARY

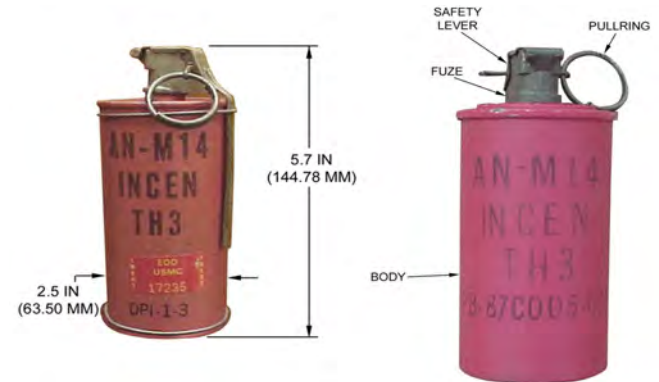

N.E.W. 0.48 G



## U.S. GRENADE, HAND, OFFENSIVE, MK 3A2

Ordnance used with:  
M206A2, GRENADE, STRIKER-RELEASE  
M206A1, GRENADE, STRIKER-RELEASE

N.E.W. 226.00 G

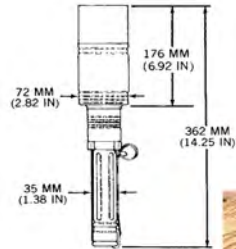

## U.S.S.R. GRENADES, HAND, HEAT, RKG-3, RKG-3T & RKG-3M

N.E.W. 604.00 G



**GREEK GRENADE, 76-MM, SMOKE,  
MULTISPECTRAL, NM186**



---

**SWEDISH GRENADE, 76-MM, PROJECTED, SMOKE  
(HC), DM45F1**



## U.S.S.R. GRENADE, HAND, HEAT, RKG-3EM

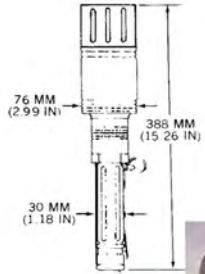

N.E.W. 434.00 G

## BELGIAN PROJECTILE FUZE, PD, NR 2117



---

## BELGIAN PROJECTILE FUZE, PD, NR 2421

Ordnance used with:  
NR 483A1, 106MM, CARTRIDGE, HE-AP, RECOILLESS...  
NR 483A1, 106MM, HE-AP



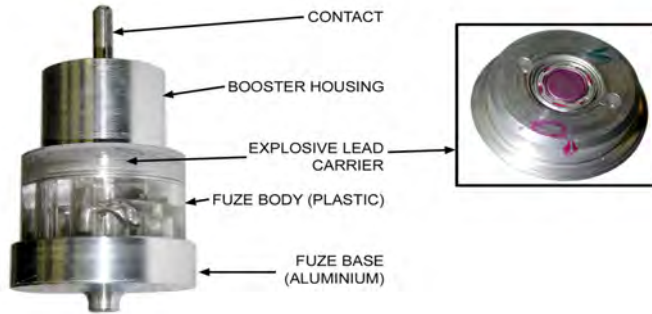

## BULGARIAN ROCKET FUZE, BASE DETONATING ELEMENT, VP-22 BP

Ordnance used with:  
PG-7L, 94MM, HEAT  
VP-22, ROCKET, PIBD  
VP-16 G CH, ROCKET, PIBD, POINT INITIATING EL...

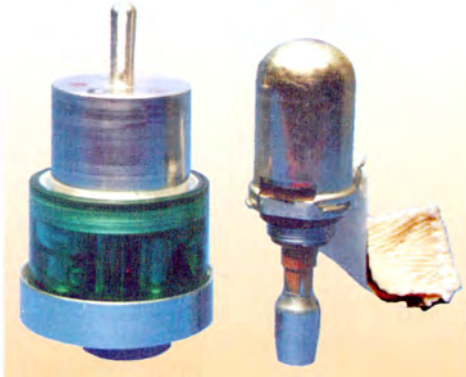

## BULGARIAN ROCKET FUZE, PIBD, VP-22

Ordnance used with:  
PG-7L, 94MM, HEAT  
VP-16 G CH, ROCKET, PIBD, POINT INITIATING EL...  
VP-22 BP, FUZE, ROCKET, PIBD, BASE DETONATING...

## **BULGARIAN ROCKET FUZE, POINT-INITIATING ELEMENT, VP-16 G CH**

Ordnance used with:  
PG-16, 58MM, HEAT-T  
PG-7L, 94MM, HEAT  
VP-22, ROCKET, PIBD  
PG 22, 72MM, HEAT  
VP-22 BP, FUZE, ROCKET, PIBD, BASE DETONATING...  
VP-9 D CH, ROCKET, PIBD, BASE DETONATING ELEMENT



---

## **ITALIAN LANDMINE FUZE, ELECTRONIC, MODEL UNKNOWN**

Ordnance used with:  
TCE/6, AT, ELECT.

DIMENSIONS UNKNOWN

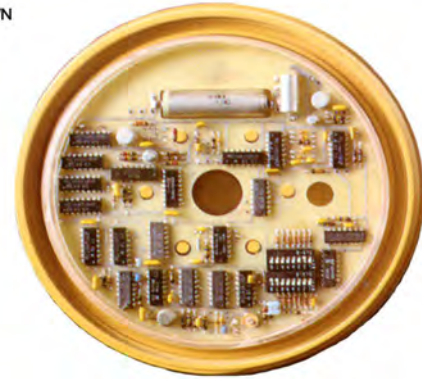



## U.S. GUIDED MISSILE WARHEAD ARMING DEVICE, MAU-191/A

Ordnance used with:  
FMU-139A/B, NOSE & TAIL, IMPACT  
AGM-86C, AIR-TO-SURFACE, CALCM  
AGM-86D, CALCM  
UNDESIGNATED, FORWARD SECTION, F/ AGM-86D

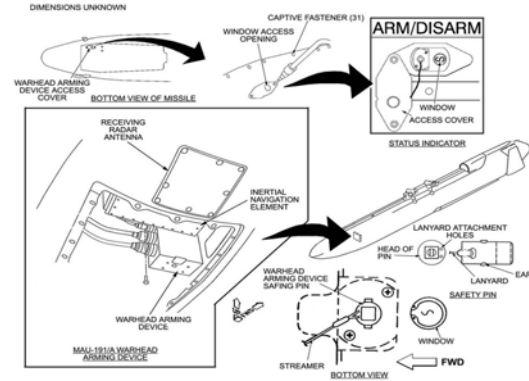

## U.S. PROJECTILE FUZE, GRAZE-SENSITIVE PD, M759

Ordnance used with:  
M789, 30-MM, CARTRIDGE, HEDP  
M799, 30-MM, CARTRIDGE, HEI  
M789, 30-MM, HEDP  
M799, 30-MM, HEI  
UNDESIGNATED, STAB DET. (F/M759)  
UNDESIGNATED, LEAD (310 MG PBXN-5)

N.E.W. 2.00 G





## U.S. PROJECTILE FUZE, PDSQ, FMU-154/B

Ordnance used with:  
PGU-9C/B, CARTRIDGE, 40-MM, HEI  
PGU-9C/B, PROJECTILE, 40-MM, HEI

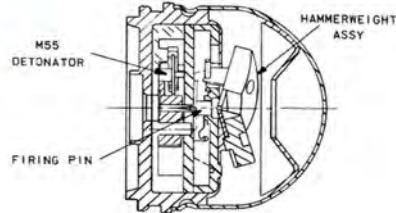

## U.S. PROJECTILE FUZE, PIBD, M550

Ordnance used with:  
M433, 40MM, CARTRIDGE, HEDP  
M433, 40 MM, HEDP  
M55, STAB PRIMER  
XM1060, 40MM, CARTRIDGE, APERS, MULTIPURPOSE ...

N.E.W. 2.00 G



## U.S.S.R. BOMB FIN ASSEMBLY, AVU-551

Ordnance used with:  
FAB-500 SHN, GENERAL PURPOSE, 500 KG

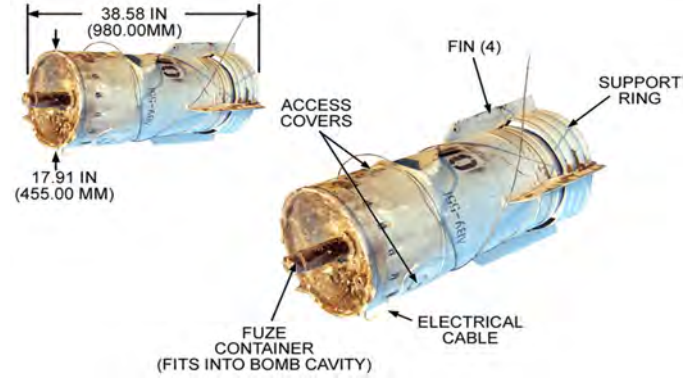

## U.S.S.R. BOMB FUZE, AMV-AE



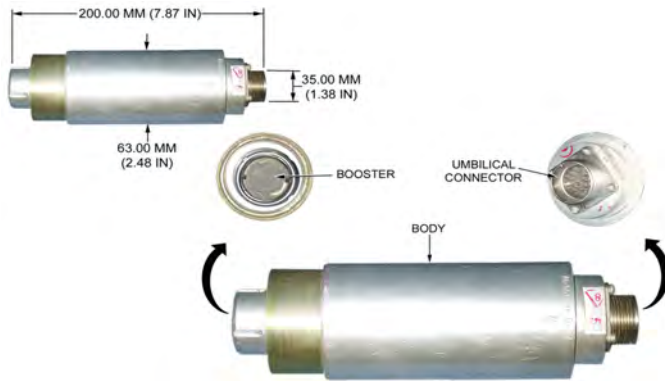

**U.S.S.R. BOMB FUZE, TAIL, IMPACT/SELF DESTRUCT, AV-551**

**DIMENSIONS UNKNOWN**



**U.S.S.R. BOMB IGNITER, FIRE BOMB, PFK-ZB 250SH**

Ordnance used with:  
 AVU-ETM, BOMB FUZE  
 PFK ZAB-500-400, INCENDIARY  
 PK.K ZAB-500-400, INCENDIARY  
 ZAB-500-400, BOMB, INCENDIARY  
 ZAB-250SH, INCENDIARY

## U.S.S.R. LANDMINE FUZE, AT, PRESSURE, MVCH-62

Ordnance used with:  
TM-62B, AT, PAPER-COATED  
TM-62D, AT, WOOD  
TM-62M, AT  
TM-62P, AT, PLASTIC  
TM-62P2, AT, PLASTIC  
TM-62P3, AT, PLASTIC



## U.S.S.R. LANDMINE FUZE, AT, TILTROD, MVSH 57 WITH TM-57 LANDMINE

Ordnance used with:  
TM-57, AT



## U.S.S.R. LANDMINE FUZE, PRESSURE, AT, MVZ-57



Ordnance used with:  
TM-57, AT

N.E.W. 2.00 G

---

## U.S.S.R. PROJECTILE FUZE, PD, A-670M

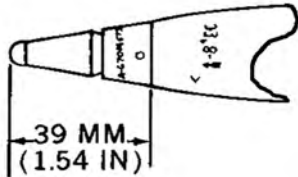

Ordnance used with:  
FT, 30-MM, HE-T  
OR-84, 30MM, HE-T  
OT, 30-MM, HE-T  
OT-30, 30-MM, HE-T  
JOSV, 30 MM, HEIT  
OFZ, 30MM X 165MM, CARTRIDGE, HEI  
UOF-84, 30MM X 165MM, CARTRIDGE, HEI

## U.S.S.R. PROJECTILE FUZE, PD, B-23A

Ordnance used with:

OFZ, 23MM, HEI

OFZT, 23-MM, CARTRIDGE, HEI-T

OFZT, 23MM X 115MM, CARTRIDGE, HEI-T

OFZT, 23-MM, HEI-T

N.E.W. 2.00 G



## U.S.S.R. PROJECTILE FUZE, PD, VMG

Ordnance used with:

VOG-26, 30-MM, CARTRIDGE, FRAG

7P9M, CARTRIDGE, 30MM, FRAG

VOG-17M, CARTRIDGE, 30MM, FRAG

VOG-26, 30-MM, FRAGMENTATION

7P9M, 30-MM, FRAGMENTATION

VOG-17M, 30-MM, FRAGMENTATION

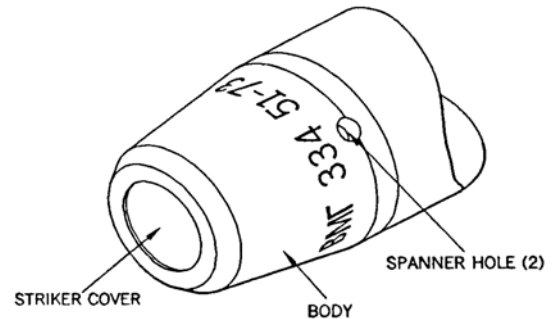



### **U.S.S.R. PROJECTILE FUZE, PDS, V-19U**

Ordnance used with:  
OFZ, CARTRIDGE, 23-MM, HEI, (23MM X 152MM)  
OFZ, 23-MM, HEI

N.E.W. 6.00 G

---



### **U.S.S.R. PROJECTILE FUZE, PDS, V19UK**

Ordnance used with:  
OFZ, CARTRIDGE, 23-MM, HEI, (23MM X 152MM)  
OFZ, 23-MM, HEI

N.E.W. 6.00 G

---

## U.S.S.R. PROJECTILE FUZE, PDSD, VMG-M

Ordnance used with:  
VOG-26, 30-MM, CARTRIDGE, FRAG  
VOG-25, 40MM, FRAG  
7P9M, CARTRIDGE, 30MM, FRAG  
VOG-17M, CARTRIDGE, 30MM, FRAG  
VOG-26, 30-MM, FRAGMENTATION  
7P9M, 30-MM, FRAGMENTATION

N.E.W. 1.00 G

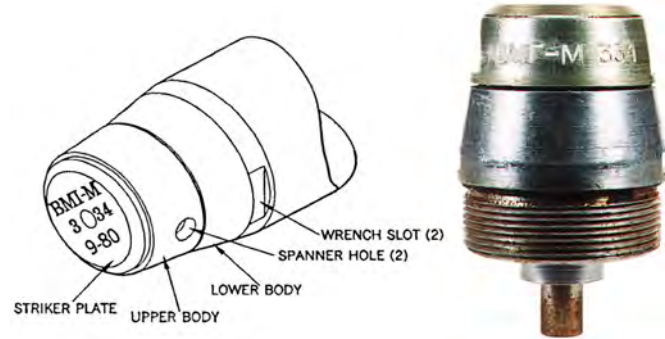

## U.S.S.R. PROJECTILE FUZE, PIBD, VP-9

Ordnance used with:  
PG-9S, 73-MM, HEAT-T  
PG-9, 73-MM, HEAT-T



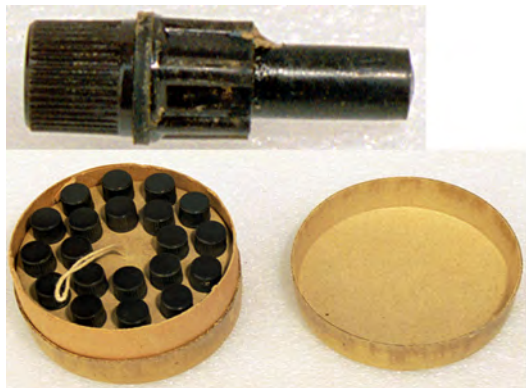

### YUGOSLAV LANDMINE FUZE, APERS, PRESSURE, UPMAH-1

Ordnance used with:  
PMA-1, APERS  
PMA-1A, APERS



### YUGOSLAV LANDMINE FUZE, APERS, PRESSURE/ PULL, UPROM-1

Ordnance used with:  
PROM-1, APERS, BOUNDING  
PPMP-2, LANDMINE, APERS, STAKE



## U.S.S.R. FIRING DEVICE, PULL/PRESSURE, MUV-2

Ordnance used with:  
UNKNOWN, APERS, CYLINDRICAL  
MON-100, APERS, DIRECTIONAL  
MON-200, APERS, DIRECTIONAL  
MON-50, APERS, CLAYMORE  
MON-90, APERS, CLAYMORE

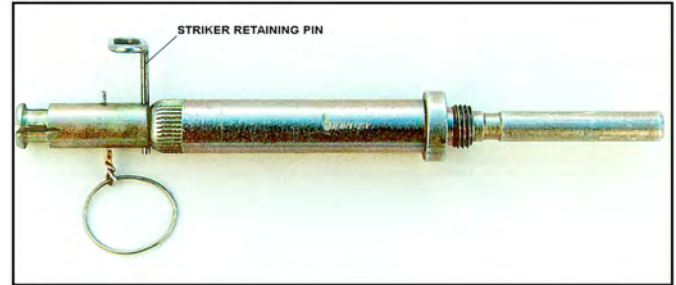

MUV-2 FITTED WITH A PERCUSSION DETONATOR ASSEMBLY

## U.S.S.R. LANDMINE FUZE, PULL, MUV

Ordnance used with:  
UNKNOWN, APERS, CYLINDRICAL  
MON-100, APERS, DIRECTIONAL  
MON-200, APERS, DIRECTIONAL  
MON-50, APERS, CLAYMORE  
MON-90, APERS, CLAYMORE

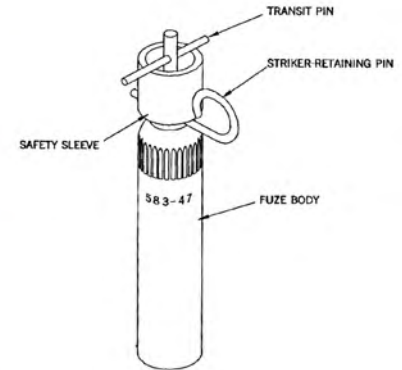

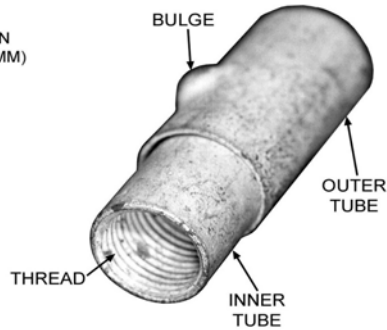
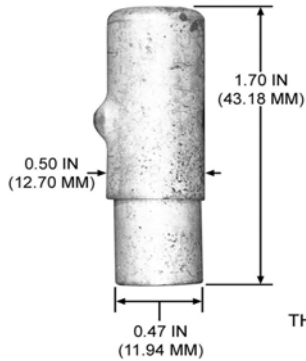

### YUGOSLAV LANDMINE FUZE, PRESSURE, MV-5

Ordnance used with:  
TMD-1, ANTITANK, WOOD  
MKTBT, AT

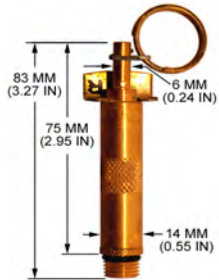

### IRANIAN LANDMINE FUZE, PRESSURE, MODEL UNKNOWN (NO. 4, PEDAL)

Ordnance used with:  
NO 4, APERS, PLASTIC (PEDAL)

**COUNTRY UNKNOWN FIRING DEVICE, PULL, BRASS, MODEL UNKNOWN**

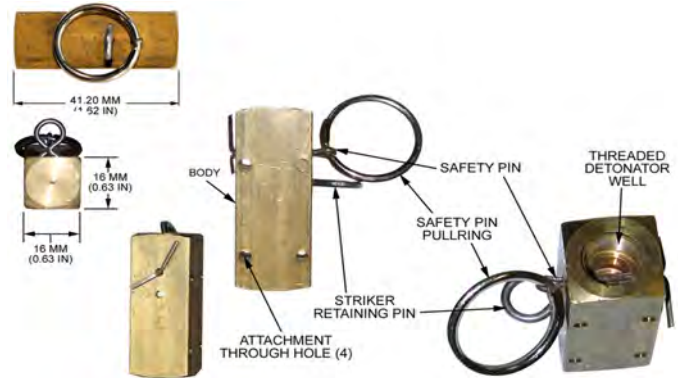

**U.S.S.R. BOMB FUZE ARMING DELAY MECHANISM, MDV-2**

Ordnance used with:  
UNKNOWN, 100KG, HIGH-DRAG  
AM-A, BOMB, NOSE  
AM A B/V, BOMB, NOSE  
AM B, BOMB, NOSE





## U.S.S.R. BOMB FUZE ARMING DELAY MECHANISM, MDV-4

Ordnance used with:  
UNKNOWN, 100KG, HIGH-DRAG  
AGDT B, BOMB, NOSE  
TM-24A, BOMB, NOSE OR TAIL  
TM-24B, BOMB, NOSE OR TAIL, MT  
UNKNOWN, RUNWAY PENETRATION, 50 KG, (DIBBER)

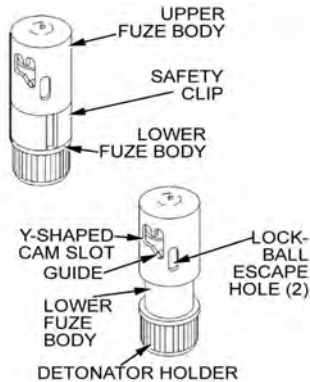

## IRANIAN LANDMINE FUZE, AT, PRESSURE, MODEL UNKNOWN

Ordnance used with:  
YM III, ANTI TANK  
YM-3, ANTITANK

## U.S.S.R., BULGARIAN, AND POLISH GRENADE FUZES, STRIKER-RELEASE, UZRG, UZRGM, UZRGM-2

Ordnance used with:  
 F-1, HAND, FRAG  
 TIP F-1, HAND, FRAG  
 RG-42, HAND, FRAG  
 MDL. 59, HAND, FRAG  
 RGD-5, HAND, FRAG  
 UNKNOWN, HAND, HE-FRAG, MINI  
 F-1, HAND, FRAG

N.E.W. 2.10 G

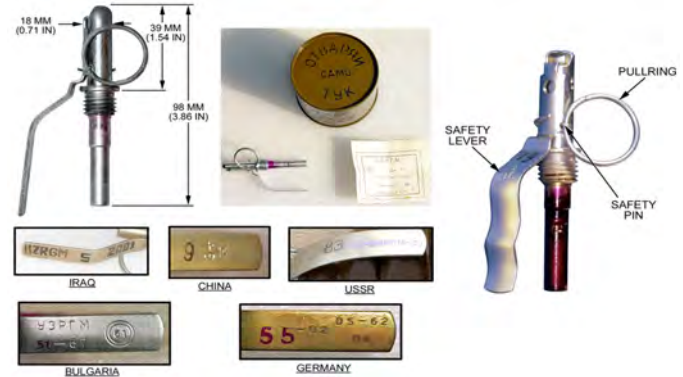

## YUGOSLAV LANDMINE FUZE, PRESSURE, UANU-1

Ordnance used with:  
 TMA-1A, AT  
 TMA-2, AT  
 TMA-5, AT  
 TMA-5A, AT  
 TM-100, APERS  
 TM-200, APERS  
 TM-500, APERS

N.E.W. 2.20 G

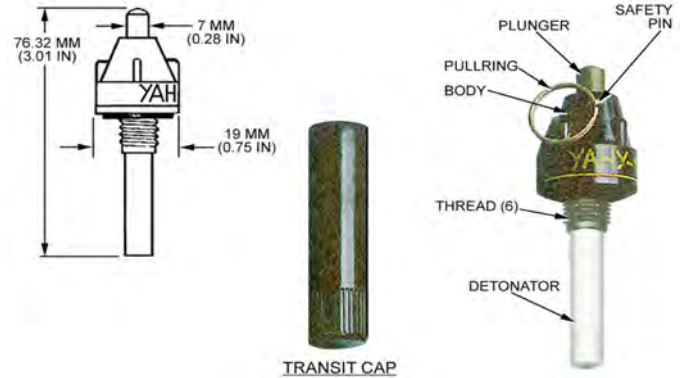

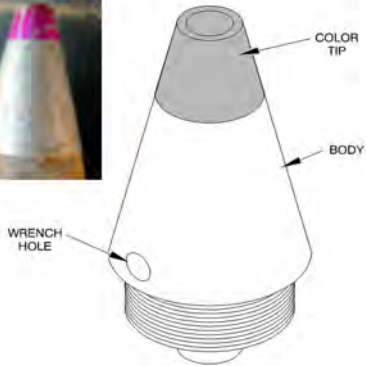
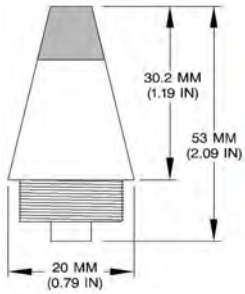

### BULGARIAN PROJECTILE FUZE, PDSD, MG-25

Ordnance used with:  
OFZT, 23MM, HEI-T  
OFZT, CARTRIDGE, 23MM, HEI-T

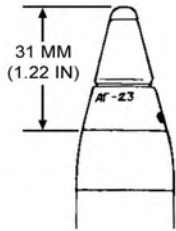

### U.S.S.R. PROJECTILE FUZE, PD, AG-23

Ordnance used with:  
OFZ, CARTRIDGE, 23-MM, HEI (23MM X 115MM)  
OFZ, 23-MM, FRAG-HEI

## U.S.S.R. PROJECTILE FUZE, PDSD, MG-25

Ordnance used with:  
OFZT, CARTRIDGE, 23MM X 152MM, FRAG-HEIT  
OFZT, 23MM, FRAG-HEIT  
OFZT, 23-MM, HEI-T

N.E.W. 6.00 G

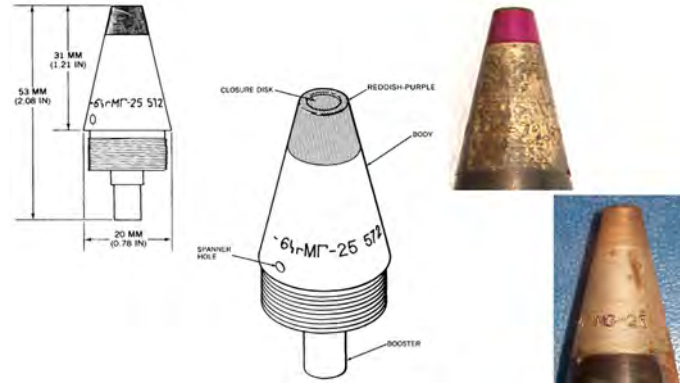

## BULGARIAN FUZE, VP-9, ROCKET, PIBD (VP-9 G CH AND VP-9 D CH)

Ordnance used with:  
PG-15, CARTRIDGE, 73-MM, HEAT-T  
PG-15V, CARTRIDGE, 73MM, HEAT  
PG-9, 73MM, HEAT  
PG-15VN, CARTRIDGE, 73MM, HEAT  
PG-9N, 73MM, HEAT  
PG-9V, 73MM, CARTRIDGE, ROCKET, HEAT  
PG-9VN, 73MM, CARTRIDGE, ROCKET, HEAT

N.E.W. 2.51 G



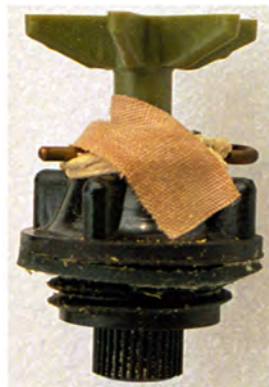

## YUGOSLAV LANDMINE FUZE, APERS, PRESSURE, UPMAH-2

Ordnance used with:  
PMA-2, APERS

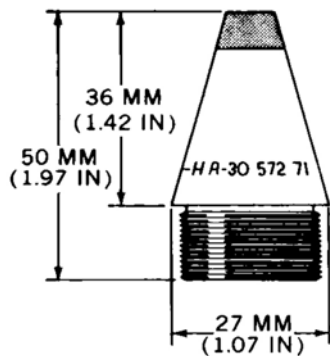

## U.S.S.R. PROJECTILE FUZE, PD, A-30

Ordnance used with:  
OFZ, 30-MM, HEI  
OFZ, 30-MM, CARTRIDGE, HEI

N.E.W. 2.00 G



## RUSSIAN PROJECTILE FUZE, BD, BD-30

Ordnance used with:  
OFT, CARTRIDGE, 30-MM, APHEI (EARLY)  
OFT, 30MM, APHEI (EARLY)  
BR-30, 30-MM, APHE

N.E.W. 16.00 G

---



## CHINESE PROJECTILE FUZE, BD, TYPE 4

Ordnance used with:  
DK 82, CARTRIDGE, 82MM, HEAT  
TYPE 65  
TYPE 56, 80MM, HEAT, (VARIANT 3)  
TYPE 56, 80MM, HEAT, MODIFIED  
PG-2, 80MM, HEAT  
TYPE 56, 80MM, HEAT

N.E.W. 11.00 G

---





### **RUSSIAN PROJECTILE FUZE, BD, BDM-30**

Ordnance used with:  
BR-30, TYPE II, 30-MM, APHEI  
OFT, 30MM, APHEI (CURRENT)  
OFT, CARTRIDGE, 30-MM, APHEI (CURRENT)

N.E.W. 26.00 G

---



### **ITALIAN LANDMINE FIRING DEVICE, ANTILIFT, MODEL UNKNOWN**

Ordnance used with:  
TC-6, AT  
TC/6

---

## U.S.S.R. PROJECTILE FUZE, PDSD, B-37

Ordnance used with:

OR-167, 37-MM, FRAG-T

OR-167N, 37-MM, FRAG-T

UOR-167, 37-MM, CARTRIDGE, FRAG-T

UOR-167N, 37-MM X 253RMM, CARTRIDGE, FRAG-T

UOR-167N, 37-MM, CARTRIDGE, FRAG-T

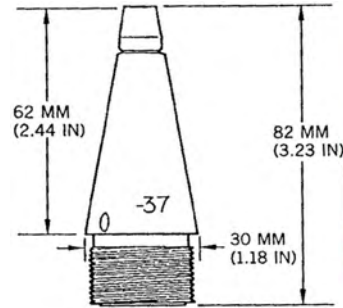

N.E.W. 5.00 G

## U.S.S.R. BOMB FUZE, NOSE, AM-A

Ordnance used with:

OFAB 100NV, BOMB, FRAG, 100 KG

AO 1 SCH, BOMB, HE

AO-1SCH

AOKH-10, BOMB, FRAGMENTATION/CHEMICAL

AOKH-8, BOMB, FRAGMENTATION/CHEMICAL

KHAB-100, BOMB, CHEMICAL

P 50 75, BOMB, PRACTICE

N.E.W. 7.00 G

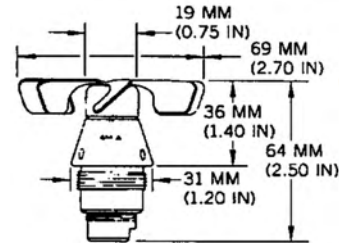

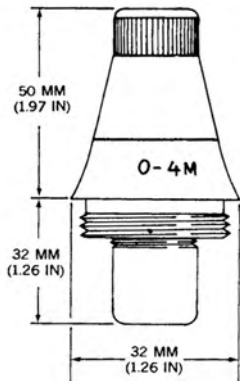

## BULGARIAN PROJECTILE FUZE, PD, O-4M

Ordnance used with:

- OG-7V, 40MM, CARTRIDGE, FRAG
- OG-7VM, 40MM, CARTRIDGE, FRAG
- OG-9, 73-MM, HE-FRAG
- OG-9BG, 73MM, HERA
- OG-9G
- OG-9M, PROJECTILE, 73MM, FRAGMENTATION
- OG-9B, 73MM, HE-FRAG

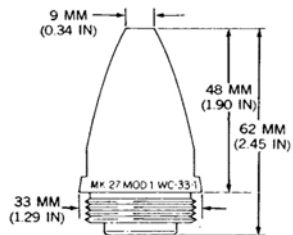

## U.S. PROJECTILE FUZES, PD, MK 27 MODS 0 & 1

Ordnance used with:

- MK 1 MOD 1, 40-MM, HE-SD, AA
- MK 1 MOD 10, 40-MM, HE-SD, AA
- MK 1 MOD 11, 40-MM, HE-SD, AA
- MK 1 MOD 12, 40-MM, HE-SD, AA
- MK 1 MOD 13, 40-MM, HE-SD, AA
- MK 1 MOD 14, 40-MM, HE-SD, AA
- MK 1 MOD 15, 40-MM, HE-SD, AA

N.E.W. 6.00 G

## U.S.S.R. PROJECTILE FUZE, BD, MD-10

Ordnance used with:

BR-471B, 122-MM, APHE-T

BZR-271, 57-MM, APHEI-T

UBR-270, CARTRIDGE, 57-MM, APHE-T

UBR-271, CARTRIDGE, 57-MM, APHE-T

UBR-271K, 57-MM, CARTRIDGE, APHE-T

UBR-281, 57-MM, CARTRIDGE, APHE-T (57MM X 348MM)

UBR-281U, 57-MM, CART., APHE-T (57MM X 348MM)

N.E.W. 13.00 G



## U.K. FIRING DEVICE, SWITCH, PRESSURE, NO. 5 MK 1

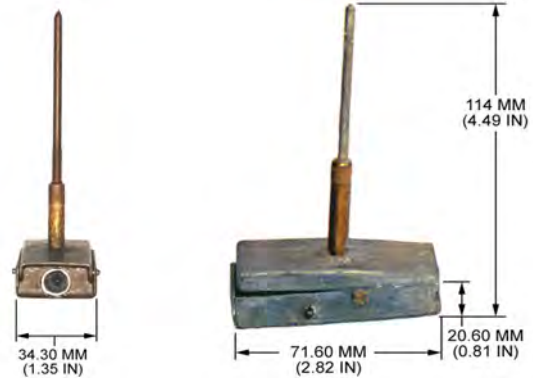

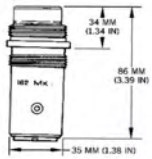

## U.K. PROJECTILE FUZE, PD, NO. 162 MK 10

Ordnance used with:

- L10A2, 81-MM, MORTAR, HE
- L15A1, 81MM, HE, MORTAR
- L15A3, 81MM, HE, MORTAR
- L15A4, 81MM, HE, MORTAR
- L19A1, 81 MM, SMOKE WP, MORTAR
- MK 7, 3-INCH, HE, MORTAR
- MK 7, 3-INCH, SMOKE, MORTAR

N.E.W. 36.00 G

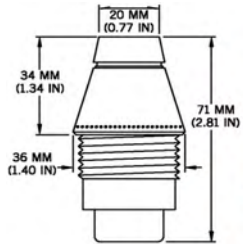

## CHINESE PROJECTILE FUZE, PD, MP-1 (TYPE 1)

Ordnance used with:

- TYPE 60-1, 60-MM, SMOKE WP
- TYPE 63-1, TYPE 60-1, 60-MM, MORTAR, SMOKE, WP
- TYPE 60-2, 60-MM, HE, MORTAR
- TH521, 82-MM, HE
- TYPE 53, 82-MM, HE
- TYPE 53, 82 MM, SMOKE, WP
- TYPE 63, 60 MM, HE

N.E.W. 9.00 G

## CHINESE PROJECTILE FUZE, PD, MP-1A

Ordnance used with:

TYPE 60-1, 60-MM, SMOKE WP  
TYPE 63-1, TYPE 60-1, 60-MM, MORTAR, SMOKE, WP  
TYPE 60-2, 60-MM, HE, MORTAR  
TH521, 82-MM, HE  
TYPE 53, 82-MM, HE  
TYPE 53, 82 MM, SMOKE, WP  
TYPE 63, 60 MM, HE

N.E.W. 9.00 G

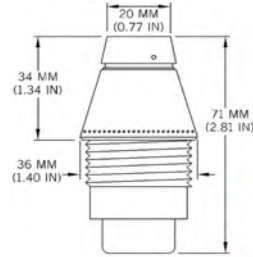

## CHINESE PROJECTILE FUZE, PD, MP-1B

Ordnance used with:

TYPE 60-1, 60-MM, SMOKE WP  
TYPE 63-1, TYPE 60-1, 60-MM, MORTAR, SMOKE, WP  
TYPE 60-2, 60-MM, HE, MORTAR  
TH521, 82-MM, HE  
TYPE 53, 82-MM, HE  
TYPE 53, 82 MM, SMOKE, WP  
TYPE 63, 60 MM, HE

N.E.W. 9.00 G

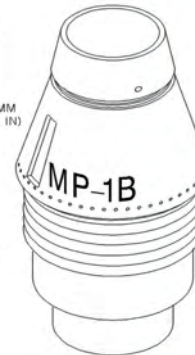
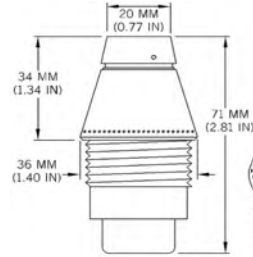

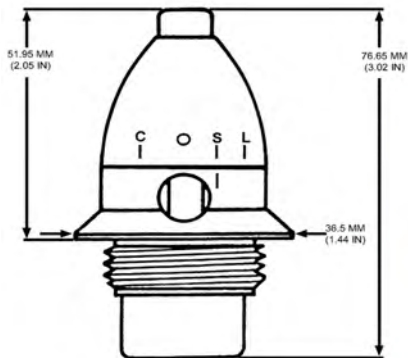

**FRENCH PROJECTILE FUZE, PD, SC 14E**

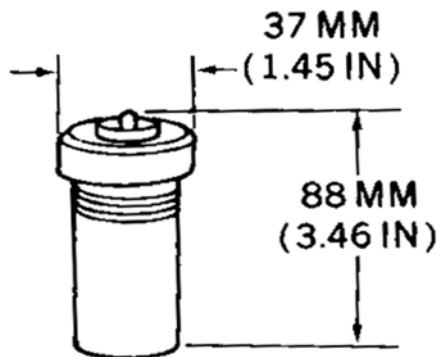

**U.K. LANDMINE FUZE, AT, PRESSURE, NO. 3 MK 1**

Ordnance used with:  
 GS MK IV, AT  
 MK 4, G.S., ANTITANK MINE  
 MK IV, G.S. ANTITANK  
 GS MK V, AT  
 MK 5, G.S., ANTITANK  
 GS MK V HC, AT  
 GS MK VC, AT



## CHINESE PROJECTILE FUZE, PD, MM-6

Ordnance used with:  
UNKNOWN, 82 MM, MORTAR, HE  
SAEGHEH, 40MM, HE  
TYPE 42-832, 82MM, HE, MORTAR  
SAEGHEH, CARTRIDGE, 40MM, HE

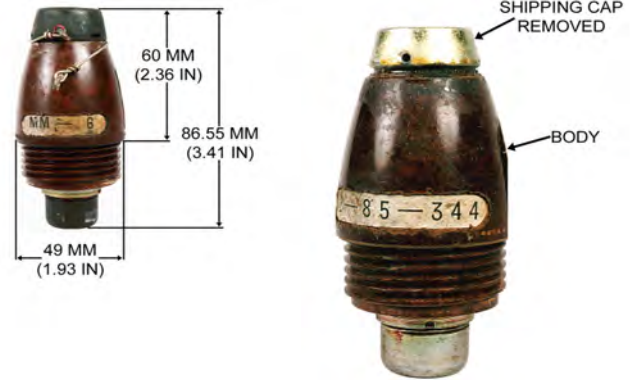

N.E.W. 8.37 G

## CHINESE PROJECTILE FUZE, PD, MODEL-2

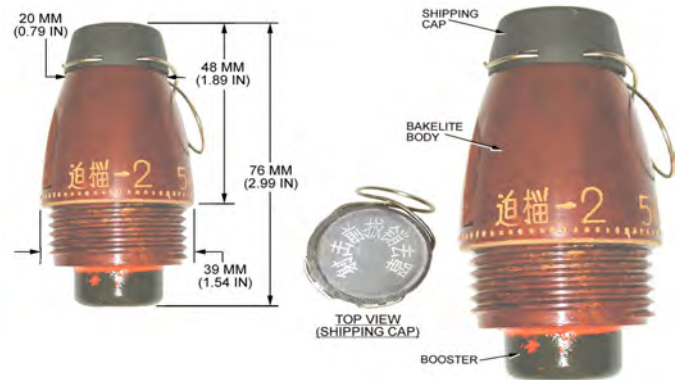

N.E.W. 6.80 G

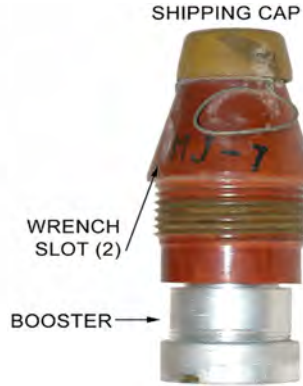
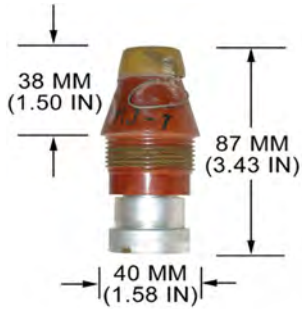

## CHINESE ROCKET FUZE, PI, MJ-7

Ordnance used with:  
 DZGI-40, 75MM, APERS, BOUNDING  
 TYPE 69, 75 MM, APERS, BOUNDING

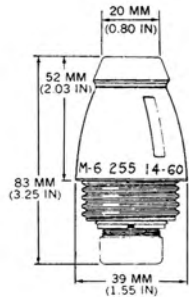

## U.S.S.R. PROJECTILE FUZE, PD, M-6

Ordnance used with:  
 M30, 82MM, MORTAR, HE  
 O-832DU, 82-MM, FRAG  
 O-832D, 82-MM, MORTAR, FRAG  
 D-832, 82-MM, MORTAR, SMOKE, WP  
 D-832DU, 82-MM, MORTAR, SMOKE, WP  
 O-832, 82-MM, FRAG  
 UNKNOWN, 75 MM, HE  
 N.E.W. 8.00 G

## BULGARIAN PROJECTILE FUZE, PD, RGM-2

Ordnance used with:  
FE-462, 122 MM, HE, FRAG  
FE-462, 122MM, HE



## BULGARIAN PROJECTILE FUZE, PDSD, VUBS-1M



N.E.W. 12.50 G

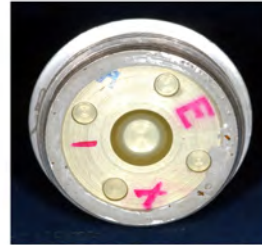

**BULGARIAN ROCKET FUZE, PD, V-5K**



**CHINESE PROJECTILE FUZE, PD, M-12**

Ordnance used with:  
 TYPE 843, 120-MM, HE  
 TYPE 843B, 120 MM, HE  
 TYPE 55, 120-MM, HE  
 TYPE 71, 100MM, HE, MORTAR  
 NASR, 81-MM, HE, A-TO-S OR S-TO-S  
 NASSAR 81, 81-MM, HE, A-TO-S OR S-TO-S  
 NASSER 81, 81-MM, HE, A-TO-S OR S-TO-S  
 N.E.W. 30.00 G

## CHINESE PROJECTILE FUZE, PD, M-6

Ordnance used with:  
OG-7V, 40MM, CARTRIDGE, FRAG  
OG-7VM, 40MM, CARTRIDGE, FRAG  
TYPE 53, 82 MM, SMOKE, WP  
UNKNOWN, 75 MM, HE  
UNKNOWN, 82 MM, MORTAR, HE  
MDL. UNKNOWN, 60MM, MORTAR, HE  
UNKNOWN, 60MM, CARTRIDGE, MORTAR, HE  
N.E.W. 8.00 G

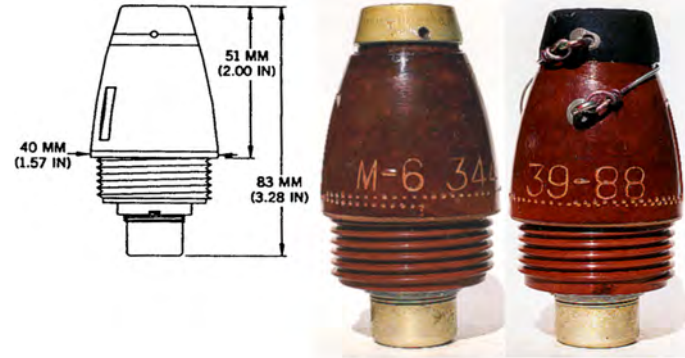

## CHINESE PROJECTILE FUZE, PD, ML-4A

Ordnance used with:  
TYPE 54, 122-MM, HE  
TYPE 83, 122MM, HE-FRAG, BB  
TYPE 83, 122MM, HE-FRAG, HB



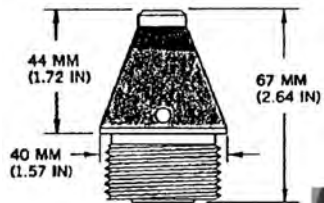

## CHINESE PROJECTILE FUZE, PD, MODEL ML-2

Ordnance used with:  
 TYPE 59, 57MM, CARTRIDGE, HE  
 TYPE 59, 57MM, HE

N.E.W. 8.00 G

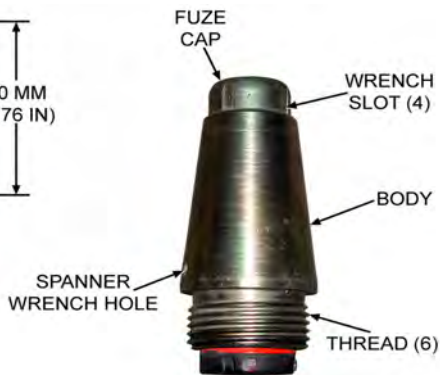

## CHINESE PROJECTILE FUZE, PD, TYPE 2

Ordnance used with:  
 MDL. 64, 82-MM, HE-FRAG  
 TYPE 64, 82MM, HE-FRAG

N.E.W. 19.00 G

## CHINESE PROJECTILE FUZE, PD, TYPE 429



N.E.W. 12.00 G

## CHINESE ROCKET FUZE, PD, MJ-1

Ordnance used with:  
TYPE 63-2, 107MM, HE, GROUND  
TYPE 63-II, 107MM, HE  
TYPE 82, 130MM, HE  
TYPE 63, 130 MM, SP  
TYPE 82, 130 MM, HEI  
TYPE 63-1, WARHEAD, 107 MM, INCENDIARY  
TYPE 63-1, 107-MM, INCENDIARY, WP

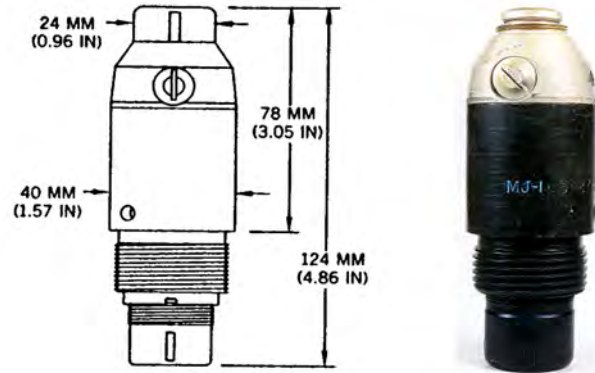

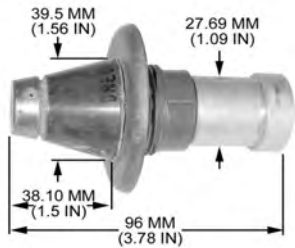

## CHINESE ROCKET FUZE, PI, DREOI

Ordnance used with:  
 DZGI-40, 75MM, APERS, BOUNDING  
 TYPE 69, 75 MM, APERS, BOUNDING



## IRANIAN PROJECTILE FUZE, PD, MM-6

Ordnance used with:  
 SAEGHEH, 40MM, HE  
 MDL. UNKNOWN, 60MM, MORTAR, HE  
 SAEGHEH, CARTRIDGE, 40MM, HE  
 UNKNOWN, 60MM, CARTRIDGE, MORTAR, HE

N.E.W. 8.30 G



## NORTH KOREAN PROJECTILE FUZE, PD, PI-2

Ordnance used with:  
O-881, 82 MM, FRAG  
O-881, CARTRIDGE, 82MM, FRAGMENTATION

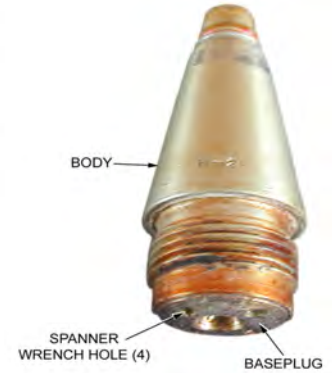

N.E.W. 1.00 G

## U.S.S.R. BOMB FUZE, AMV-AE2

Ordnance used with:  
OFAB 100 120, BOMB, FRAG



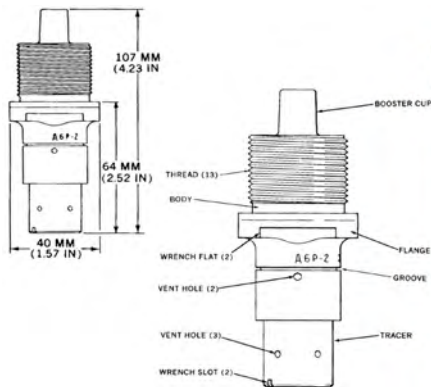

## U.S.S.R. PROJECTILE FUZE, BD, DBR-2

Ordnance used with:  
 TYPE 367, 85-MM, CARTRIDGE, APHE-T  
 UBR-367, 85-MM, CARTRIDGE, APHE-T  
 BR-367, 85-MM, APHE-T  
 TYPE 367, 85-MM, APHE-T  
 TYPE 376, 85-MM, APHE-T  
 PSV, 100-MM, APHE-T  
 BR 412B, 100-MM, AP-T

N.E.W. 0.00 G

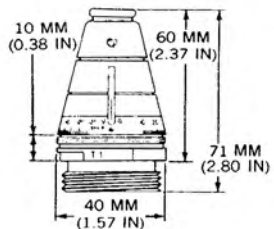

## U.S.S.R. PROJECTILE FUZE, NOSE, (TSQ), T-1

Ordnance used with:  
 KT-8, 82-MM, MORTAR, ILLUM  
 O-365, 85-MM, PROJECTILE, HE, (2 PIECE)  
 S-832S, 82-MM, ILLUM  
 S-832SM, 82 MM, ILLUM  
 S-843, 120-MM, MORTAR, ILLUMINATION  
 MDL. UNKNOWN, 120-MM, INCENDIARY  
 3D14, 120-MM, MORTAR, SMOKE

N.E.W. 9.00 G

## U.S.S.R. PROJECTILE FUZE, PD, GO-2

Ordnance used with:

OG-7V, 40MM, CARTRIDGE, FRAG

OG-7VM, 40MM, CARTRIDGE, FRAG

OG-9, 73-MM, HE-FRAG

OG-9M, 73-MM, HE-FRAG

OG-7V, 40MM, FRAG

OG-7VE, RKT PROPELLED, 85/40 MM, HE

OFG-7, RKT PROPELLED, 57/40 MM, HE

N.E.W. 8.95 G



## U.S.S.R. PROJECTILE FUZE, PD, GVMZ-7

Ordnance used with:

3100/843

MDL. 3100-843, 120-MM, SMOKE WP

F-843, 120-MM, MORTAR, HE

F-852, 160-MM, MORTAR, HE

F-853A, 160-MM, MORTAR, HE

F-853AU, 160-MM, MORTAR, HE

F 853U, 160-MM, MORTAR, HE

N.E.W. 15.00 G

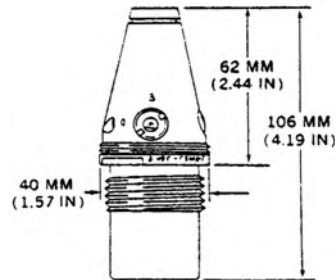

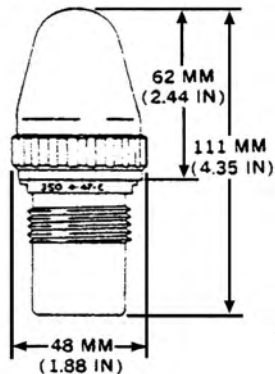

## U.S.S.R. PROJECTILE FUZE, PD, GVMZ-7, WITH SHIPPING COVER

Ordnance used with:

3100/843

MDL. 3100-843, 120-MM, SMOKE WP

F-843, 120-MM, MORTAR, HE

F-852, 160-MM, MORTAR, HE

F-853A, 160-MM, MORTAR, HE

F-853AU, 160-MM, MORTAR, HE

F 853U, 160-MM, MORTAR, HE

N.E.W. 15.00 G

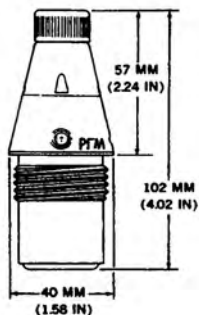

## U.S.S.R. PROJECTILE FUZE, PD, RGM

Ordnance used with:

EF-412

OF-412, 100-MM, FRAG-HE

HE-462, 122MM, HE-FRAG

OF-462, 122-MM, HE-FRAG

0-460A, 122-MM, FRAG

DTS-471, 122-MM, SMOKE

F-412, 100-MM, FRAG-HE

N.E.W. 16.00 G

## U.S.S.R. PROJECTILE FUZE, PD, RGM-2

Ordnance used with:

EF-412

OF-412, 100-MM, FRAG-HE

HE-462, 122MM, HE-FRAG

OF-462, 122-MM, HE-FRAG

O-460A, 122-MM, FRAG

MDL. UNKNOWN, 122-MM, CHEMICAL (NON-PERSISTANT)

D-4, 122-MM, SMOKE, WP

N.E.W. 16.00 G

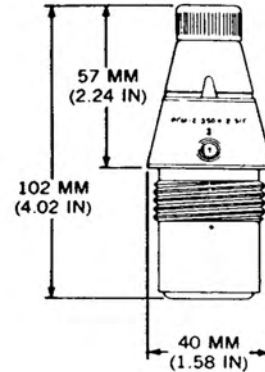

## U.S.S.R. PROJECTILE FUZE, PD, RGM-2M

Ordnance used with:

HE-462, 122MM, HE-FRAG

OF-462, 122-MM, HE-FRAG

OF25, 152-MM, FRAG-HE

OF-56, 122-MM, FRAG-HE

OF-56, 122-MM, HE

OF-56-1, 122-MM, HE



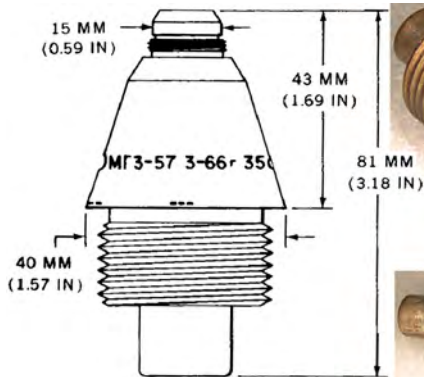

## U.S.S.R. PROJECTILE FUZE, PSD, MGZ-57

Ordnance used with:  
 OR-281, 57-MM, FRAG-T  
 OR-281U, 57-MM, FRAG-T  
 UOR-281U, CARTRIDGE, 57MM X 348MM, FRAG-T  
 UOR-281, CARTRIDGE, 57MM X 348MM, FRAG-T

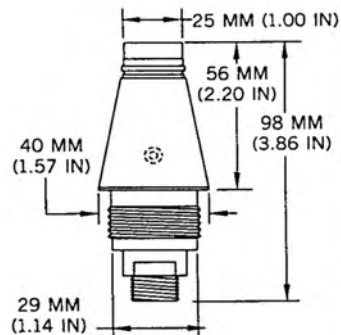

## U.S.S.R. PROJECTILE FUZE, PIBD, GPV-2

Ordnance used with:  
 BK-2M, 85-MM, HEAT-FS  
 BK-354M, 76-MM, HEAT-FS  
 BK-4M, 115-MM, HEAT-FS  
 BK-6M, 122-MM, HEAT-FS  
 BK463UM, 122-MM, HEAT-FS  
 UBK-4M, CARTRIDGE, 100-MM, HEAT-FS  
 HXG, 100-MM, HEAT-T  
 N.E.W. 5.00 G

## U.S.S.R. PROJECTILE FUZE, TSQ, D-1-U

Ordnance used with:  
OF-18, 115-MM, HE-FRAG  
3OF26, 125-MM, FRAG-HE  
OF-26, 125-MM, FRAG-HE  
OF-540, 152-MM, FRAG-HE  
OF540, 15-MM, FRAG-HE  
OF-56, 122-MM, FRAG-HE  
OF-56, 122-MM, HE

N.E.W. 17.00 G

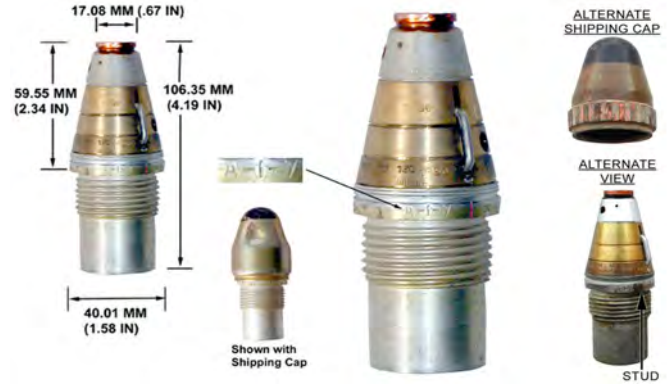

## U.S.S.R. PROJECTILE FUZES, PD, KTM-1, KTM-1U, KTM-2, KTM-3, KTMZ-1, KTMZ-1U AND KTMZ-2

Ordnance used with:  
MDL. OF, 85-MM, HE-FRAG  
O-240, 45-MM, HE-FRAG  
O-271, 57-MM, FRAG  
O-271-U, 57-MM, FRAG  
O-350A, 76-MM, FRAG  
O-365, 85-MM, PROJECTILE, HE, (2 PIECE)  
O-365K, 85-MM, FRAG

N.E.W. 9.00 G

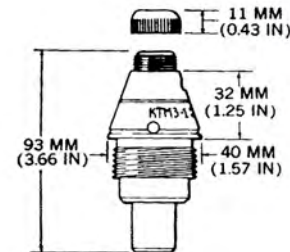

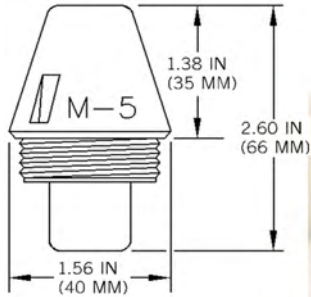

## U.S.S.R. PROJECTILE FUZES, PD, M-5 AND M-5M

Ordnance used with:

- O-832DU, 82-MM, FRAG
- O-832D, 82-MM, MORTAR, FRAG
- D-832, 82-MM, MORTAR, SMOKE, WP
- D-832DU, 82-MM, MORTAR, SMOKE, WP
- OF-843, 120-MM, MORTAR, FRAG-HE
- OF-843A, 120-MM, MORTAR, HE-FRAG
- O-832, 82-MM, FRAG

N.E.W. 11.00 G

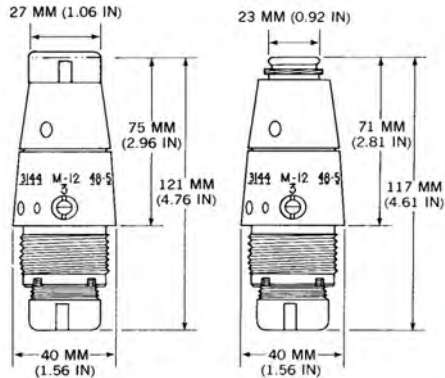

## U.S.S.R. PROJECTILE FUZES, PD, M12 & V-22

Ordnance used with:

- 3100/843
- MDL. 3100-843, 120-MM, SMOKE WP
- D-5, 120-MM, MORTAR, SMOKE (WP)
- F-843, 120-MM, MORTAR, HE
- OF-843, 120-MM, MORTAR, FRAG-HE
- OF-843A, 120-MM, MORTAR, HE-FRAG
- 3OF-843B, 120-MM, CARTRIDGE, MORTAR, FRAG-HE

N.E.W. 28.00 G



## U.S.S.R. ROCKET FUZE, NOSE, PD, V-25

Ordnance used with:

F-961, 240 MM, SPIN STABILIZED, HE, S-TO-S  
F-961U, 240 MM, SPIN STABILIZED, HE, S-TO-S  
M-14-OF, 140 MM, HE-FRAG  
MDL. UNKNOWN, WHD, 140 MM, CHEMICAL, NON-PERS...

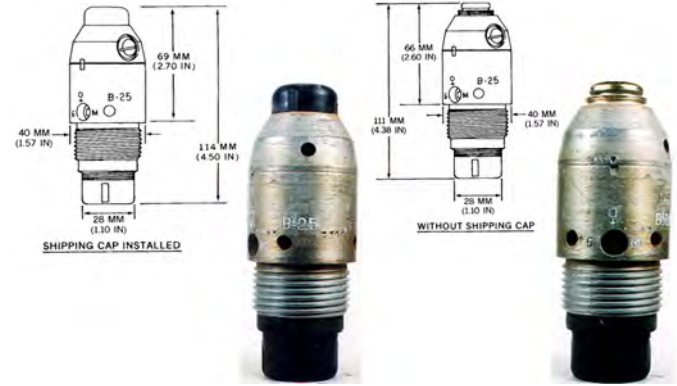

## U.S.S.R. ROCKET FUZE, PD, V-5K

Ordnance used with:

UB-16-57-U, 57-MM, LAUNCHER, RKT  
C-5K, 57-MM, HEAT, A-TO-S  
S-5K, 57-MM, HEAT, A-TO-S  
S-5KO, 57-MM, WARHEAD, HEAT-FRAG, A-TO-S  
S-5K1, 57-MM, HEAT, A-TO-S  
C-5MO, 57-MM, HE/FRAG, A-TO-S  
S-5MO, 57-MM, HE/FRAG, A-TO-S

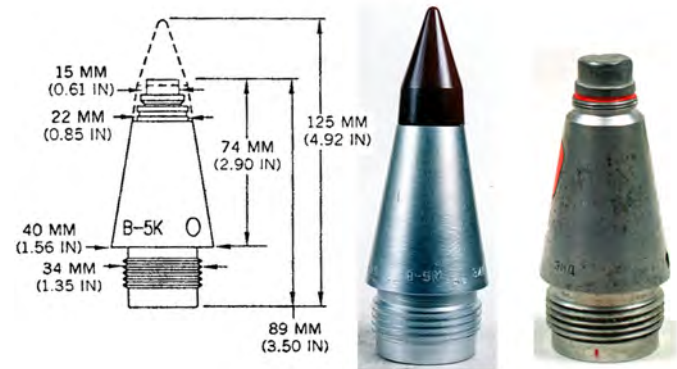



### U.S.S.R. ROCKET FUZE, PD, V-8

Ordnance used with:

S-8-OF, 80-MM, HE/FRAG, A-TO-S

S-8-OF, WARHEAD, 80-MM, HE/FRAG, A-TO-S

S-8-OF, 80-MM, MOTOR, SOLID PROPELLANT, A-TO-S



### U.S.S.R. ROCKET FUZE, PDSD, V-5M1

Ordnance used with:

UB-16-57-U, 57-MM, LAUNCHER, RKT

S-5KO, 57-MM, WARHEAD, HEAT-FRAG, A-TO-S

S-5M, 57-MM, HE, A-TO-S

S-5M1, 57-MM, HE-FRAG, A-TO-S

C-5MO, 57-MM, HE/FRAG, A-TO-S

S-5MO, 57-MM, HE/FRAG, A-TO-S

S-50, ILLUMINATION, A-TO-S

## U.S.S.R. ROCKET FUZE, VB-5

Ordnance used with:  
S-5-OB, 57-MM, WARHEAD, ILLUMINATION, A-TO-S  
S-5-01, 57-MM, ILLUMINATION, A-TO-S  
S-5-OB, 57-MM, ILLUMINATION, A-TO-S

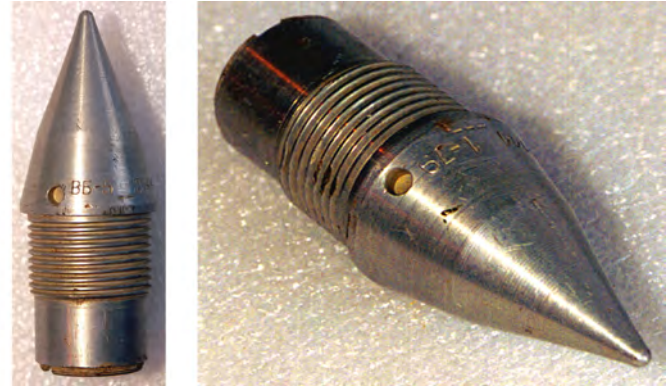

## YUGOSLAV PROJECTILE FUZE, PD, UTU, M78 / AU-29

Ordnance used with:  
M62P3, 120-MM, MORTAR, HE  
M77, 120-MM, MORTAR, HERA  
M62, 120-MM, HE, MORTAR  
M95A, 120-MM, MORTAR, HE  
M62P5, 120-MM, HE, MORTAR  
M95A, 120-MM, MORTAR, CARTRIDGE, HE  
M77, 120-MM, CARTRIDGE, MORTAR, HERA, FRAG  
N.E.W. 16.00 G

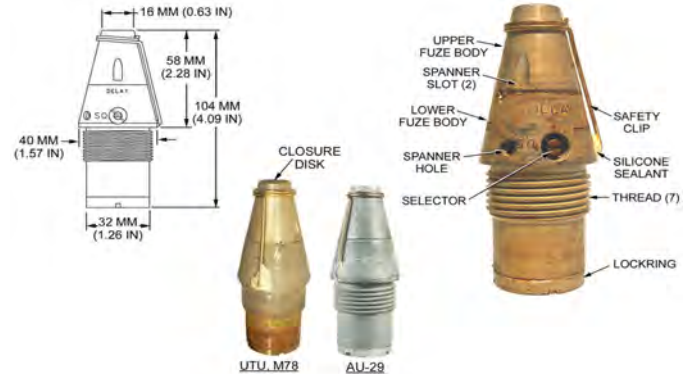

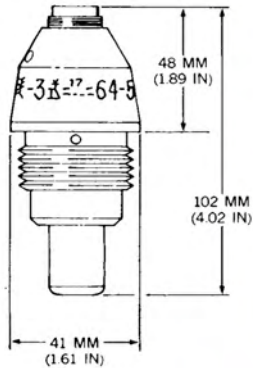

### CHINESE PROJECTILE FUZE, PD, TYPE 1 (ARTILLERY)

Ordnance used with:  
TYPE 26.12, 75MM, HE  
UNKNOWN, 57 MM, HE  
UNKNOWN, 75 MM, HE

N.E.W. 8.00 G

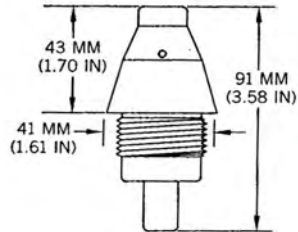

### CHINESE PROJECTILE FUZE, PD, TYPE 53 MODEL 1

Ordnance used with:  
MDL. UNKNOWN, 105 MM, HE  
UNKNOWN, CARTRIDGE, 105MM, HE

N.E.W. 14.00 G

## CHINESE PROJECTILE FUZE, PD, TYPE 53 MODEL 2

Ordnance used with:  
UNKNOWN, 75 MM, HE

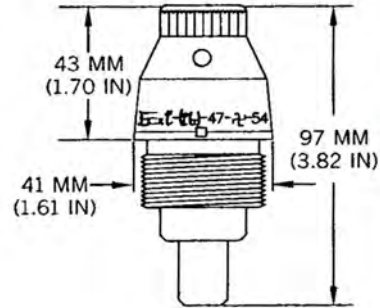

## CHINESE PROJECTILE FUZE, PD, TYPE 6 (M30P-1)

Ordnance used with:  
M30, 82MM, MORTAR, HE  
TYPE 52, 75 MM, HE, RR  
TYPE 52, CARTRIDGE, 75MM, HE  
MDL. UNKNOWN, SHIPPING-STORAGE CONTAINER FOR ...



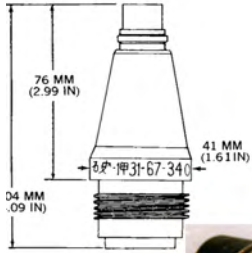

### CHINESE PROJECTILE FUZE, PIBD TYPE 1 (SPECIAL)

Ordnance used with:  
TYPE 52, 75 MM, RR, HEAT

N.E.W. 2.00 G



### CHINESE PROJECTILE FUZE, PIBD, TYPE 1

Ordnance used with:  
TYPE 52, 75 MM, RR, HEAT

## U.S.S.R. PROJECTILE FUZE, PD, MG-N

Ordnance used with:  
O-350A, 76-MM, FRAG  
OF-350, 76-MM, HE-FRAG  
OF-350A, 76-MM, HE-FRAG  
OF-350, 76-MM, HE  
M69, 85-MM, HE  
UO-367A, CARTRIDGE, 85MM, FRAG

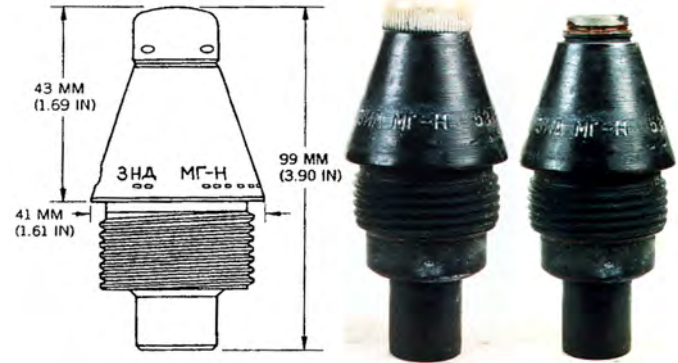

## U.S.S.R. PROJECTILE FUZE, PD, OR PIBD, GK-1

Ordnance used with:  
BK-881, 82-MM, CARTRIDGE, HEAT  
OG-82, 82 MM, FRAG-HE  
PG-82, 82 MM, HEAT  
GK-662, 82 MM, WARHEAD, HEAT  
GO-662, 82 MM, WHD.  
O-881, CARTRIDGE, 82MM, FRAGMENTATION

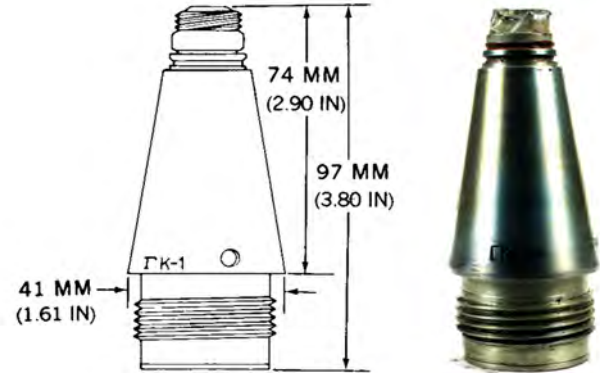

N.E.W. 2.00 G

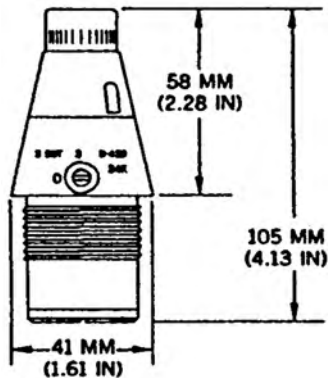

## U.S.S.R. PROJECTILE FUZES, PD, V-429 AND V-429E

Ordnance used with:

EF-412

OF-412, 100-MM, FRAG-HE

BP-460A, 122-MM, HEAT

MDL. UNKNOWN, 122-MM, CHEMICAL (NON-PERSISTANT)

DTS-1, 130-MM, SMOKE, WP

N.E.W. 16.00 G

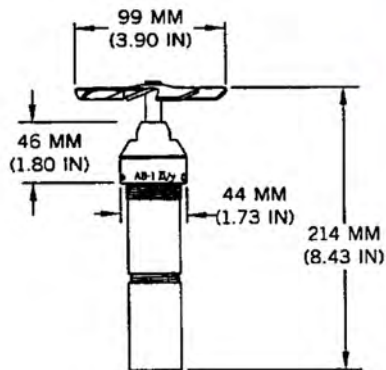

## U.S.S.R. BOMB FUZE, NOSE & TAIL, AV-1 D/U

Ordnance used with:

UNKNOWN, 100KG, HIGH-DRAG

MDL. 518, 452MM, HE

FAB-250 M46, BOMB, GENERAL PURPOSE

FAB-250 M54, BOMB, GENERAL PURPOSE

N.E.W. 52.00 G



## YUGOSLAV PROJECTILE FUZE, PD, UT M68 P1

Ordnance used with:

M73, 60-MM, HE, MORTAR  
TRM73, 60-MM, HE, MORTAR  
M72, 81-MM, HE, MORTAR  
M73, 60-MM, SMOKE, MORTAR  
M73, 60MM, CARTRIDGE, SMOKE, MORTAR  
M62P3, 120-MM, MORTAR, HE  
M74A1, 82-MM, MORTAR, HE

N.E.W. 23.45 G



## AUSTRIAN PROJECTILE FUZE, PD, M52B1

Ordnance used with:

HE 83 LD  
HE 83, 82-MM, MORTAR, HE  
HE83 LD, 82MM, HE  
HE 83 LD, CARTRIDGE, 82MM, HE

N.E.W. 17.42 G

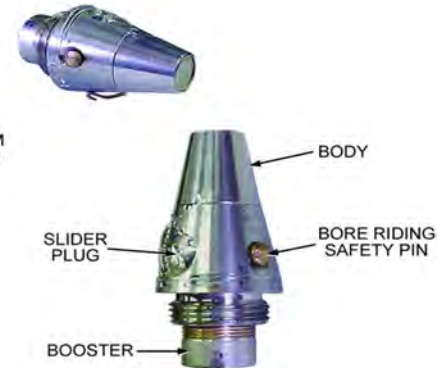



## AUSTRIAN PROJECTILE FUZE, PD, PDM525

Ordnance used with:  
 NR431A1, 60MM, HE  
 AR-M60, 60MM, HE, MORTAR  
 HE 80, 60-MM, HE  
 NR 431 A1, 60MM, CARTRIDGE, HE  
 UNKNOWN, 60MM, MORTAR, HE  
 UNKNOWN, 60MM, CARTRIDGE, MORTAR, HE  
 HE 83 LD

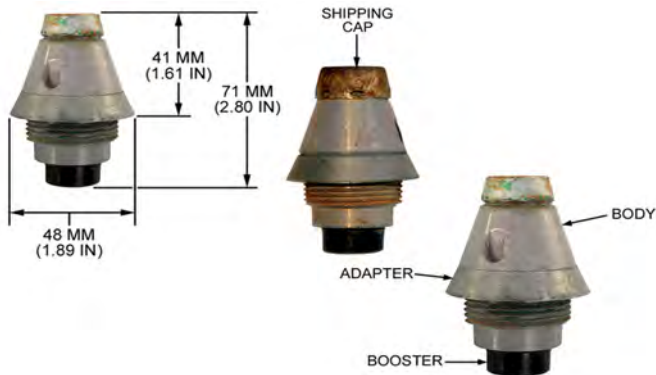

## CHINESE PROJECTILE FUZE, PD, PAI-1A

Ordnance used with:  
 TH521, 82-MM, HE  
 TYPE 53, 82-MM, HE  
 TYPE 53, 82 MM, SMOKE, WP  
 TYPE 53, 82MM, CARTRIDGE, HE, MORTAR  
 M43A1, CARTRIDGE, 81MM, HE  
 M43A1, 81MM, HE  
 M-57D MK 1, 82MM, MORTAR, HE  
 N.E.W. 6.80 G

## AUSTRIAN PROJECTILE FUZE, PD, T37A1B1

Ordnance used with:  
HE 70, 81-MM, HE  
HE 70LD, 81-MM, MORTAR, LONG DISTANCE, HE  
AR-M60, 60MM, HE, MORTAR  
HE 80, 60-MM, HE  
HE 83 LD  
HE 83, 82-MM, MORTAR, HE  
HE83 LD, 82MM, HE

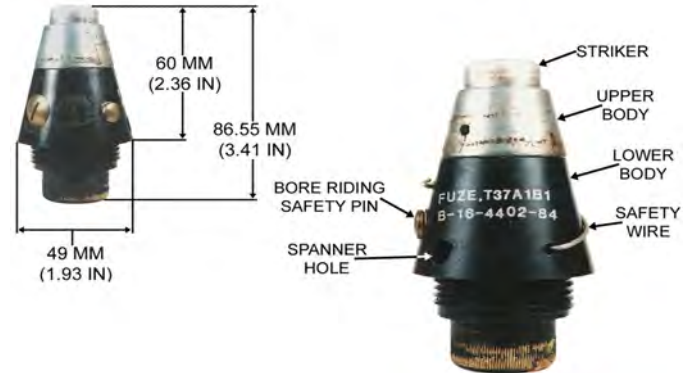

## GERMAN (FEDERAL REPUBLIC) PROJECTILE FUZE, PD, DM111A2, (AZ 111 A2), AZ DM 111A2

Ordnance used with:  
NR431A1, 60MM, HE  
BPD-IM1, 81-MM MORTAR, HE  
NM123, 81-MM, HE  
HE 70, 81-MM, HE  
HE 70LD, 81-MM, MORTAR, LONG DISTANCE, HE  
UNKNOWN, 60-MM, HE  
64, 81-MM, HE  
N.E.W. 15.00 G

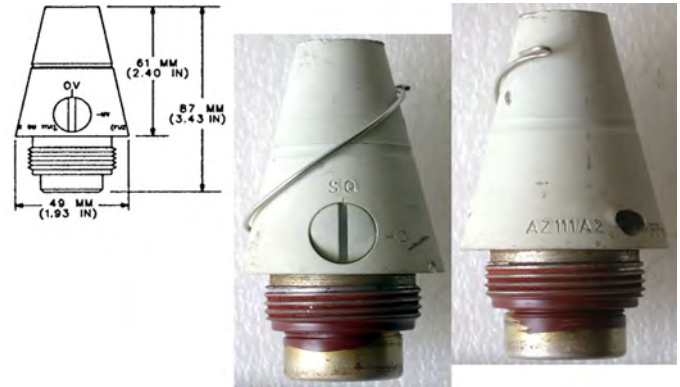



## IRANIAN PROJECTILE FUZE, PD, AZ111

Ordnance used with:  
 M73, 60-MM, HE, MORTAR  
 TRM73, 60-MM, HE, MORTAR  
 MDL. UNKNOWN, 60MM, MORTAR, HE  
 UNKNOWN, 120MM, MORTAR, HE  
 UNKNOWN, 60MM, MORTAR, HE  
 UNKNOWN, 60MM, CARTRIDGE, MORTAR, HE  
 M73, CARTRIDGE, 60-MM, MORTAR

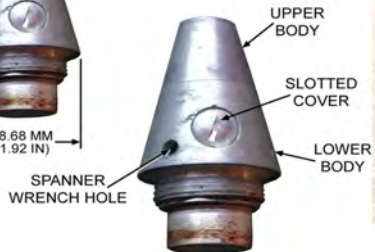

## IRANIAN PROJECTILE FUZE, PD, AZJV111A2

Ordnance used with:  
 NR431A1, 60MM, HE  
 NR 431 A1, 60MM, CARTRIDGE, HE

N.E.W. 18.00 G

## PAKISTANI PROJECTILE FUZE, PD, PAI-1A

Ordnance used with:

UNKNOWN, 60-MM, MORTAR, HE

UNKNOWN, 60-MM, SMOKE, WP, MORTAR

UNKNOWN, 60-MM, CARTRIDGE, MORTAR, HE

UNKNOWN, 60-MM, CARTRIDGE, MORTAR, SMOKE, WP

M57 DA-2, 81MM, MORTAR, HE

M-57D MK 1, 82MM, MORTAR, HE

M-57D MK 1, CARTRIDGE, 82MM, MORTAR, HE

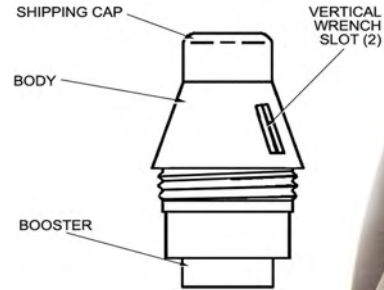

## SPANISH PROJECTILE FUZE, PD, PDB 332

Ordnance used with:

ER, 82MM, HE, MORTAR

M96, 82-MM, HE, MORTAR

ER, 82MM, CARTRIDGE, HE, MORTAR

M96, 82MM, CARTRIDGE, HE, MORTAR

ER, 82MM, SMOKE, WP, MORTAR (EXTENDED RANGE)

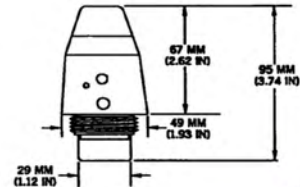

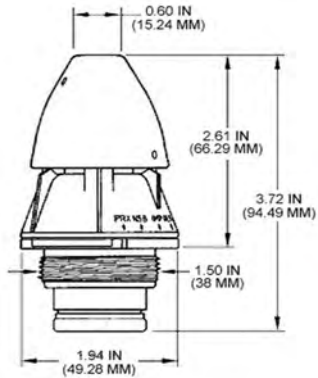

## U.S. PROJECTILE FUZE, MULTIOPTION, M734

Ordnance used with:

- M821, 81-MM, HE
- M821A1, 81MM, HE
- M888, 60-MM, HE, MORTAR
- M889, 81-MM, HE
- M889A1, 81MM, HE
- M933, PROJECTILE, 120-MM, HE, MORTAR
- M934, CARTRIDGE, 120-MM, MORTAR, HE

N.E.W. 8.42 G

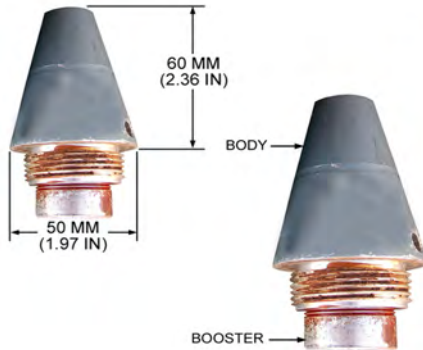

## IRANIAN PROJECTILE FUZE, PD, AZ111-A2

Ordnance used with:

- M512, 60-MM, HE, MORTAR
- UNKNOWN, 81MM, HE, MORTAR
- UNKNOWN, 120MM, MORTAR, HE
- M43A1, CARTRIDGE, 81MM, HE
- M43A1, 81MM, HE
- MDL. UNKNOWN, CARTRIDGE, 120MM, HE, MORTAR

## U.S. PROJECTILE FUZE, PD, M935

Ordnance used with:

M49A2E1, 60-MM, MORTAR, HE

M49A3, 60-MM, MORTAR, HE

M49A2E1, 60-MM, CARTRIDGE, MORTAR, HE

M49A3, 60-MM, CARTRIDGE, MORTAR, HE

M49A4, 60-MM, HE

M50A3, CARTRIDGE, 60-MM, TP

M722, CARTRIDGE, 60-MM, SMOKE, WP

N.E.W. 14.00 G

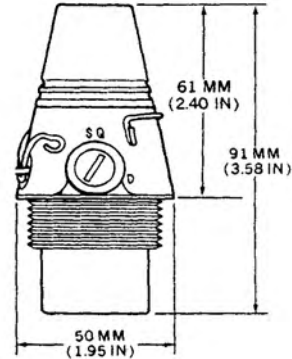

## U.S. BOMB FUZE, TAIL, IMPACT, SHORT DELAY, M905

Ordnance used with:

BLU-110A/B, BOMB, GPLD, 1,000 LB

BLU-111A/B, BOMB, GPLD, 500 LB

BLU-82/B, BOMB UNIT, BLAST, CRADLED

GBU-10/B, BOMB UNIT, GUIDED

GBU-10A/B, BOMB UNIT, GUIDED

GBU-10C/B, BOMB UNIT, GUIDED

GBU-10D/B, BOMB UNIT, GUIDED

N.E.W. 2.00 G

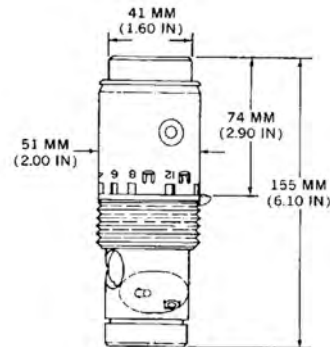

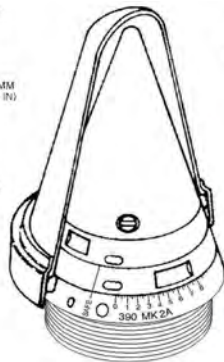
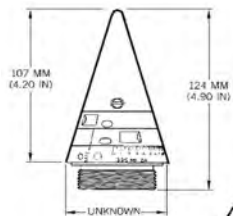

## U.K. PROJECTILE FUZE, PTT, NO. 390 MK 2A

Ordnance used with:  
 L32, CARTRIDGE, 76 MM, SMOKE  
 SX-1057  
 MK 4, 3-INCH, SMOKE, MORTAR

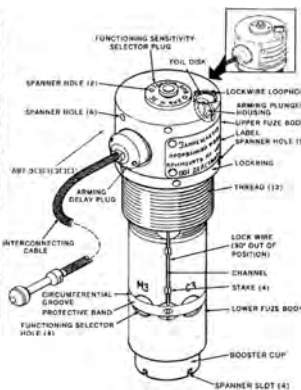
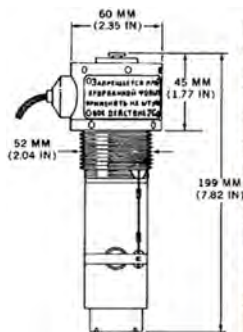

## U.S.S.R. BOMB FUZE, NOSE & TAIL, IMPACT, AVT-E

Ordnance used with:  
 FAB-1500 M54, BOMB, GENERAL PURPOSE  
 FAB-1500 M46, BOMB, GENERAL PURPOSE  
 FAB-250 M54, BOMB, GENERAL PURPOSE  
 FAB-250 SHN, BOMB, HE, RETARDED, 275 KG  
 FAB-500 M46, BOMB, GENERAL PURPOSE  
 FAB-500 M54, BOMB, GENERAL PURPOSE  
 FAB-500SH, GENERAL PURPOSE, 500 KG



## U.S.S.R. BOMB FUZE, NOSE AND TAIL, AVU

Ordnance used with:  
FAB 500, M62, BOMB, GP, 500 KG  
OFAB 100 120, BOMB, FRAG  
OFAB-250-270, BOMB, FRAGMENTATION

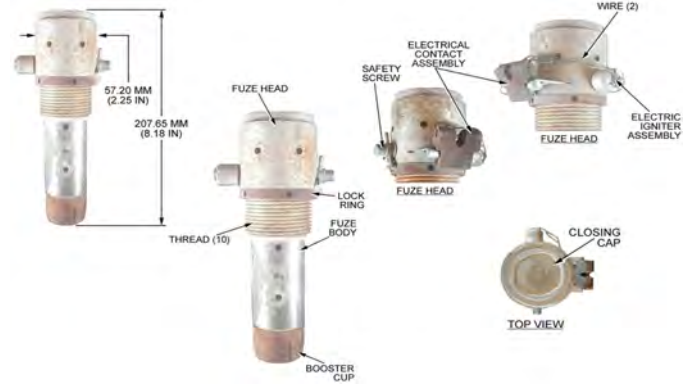

## U.S.S.R. BOMB FUZE, NOSE AND TAIL, AVU-ETM

Ordnance used with:  
OFAB 100 120, BOMB, FRAG  
PF.K ZB250SH, BOOSTER, FIRE BOMB  
PFK-ZB 250SH, IGNITER, FIRE BOMB  
PFKZB-250SH, IGNITER (INCENDIARY BOMB)  
PF.K ZB-500SH, BOOSTER, INCENDIARY

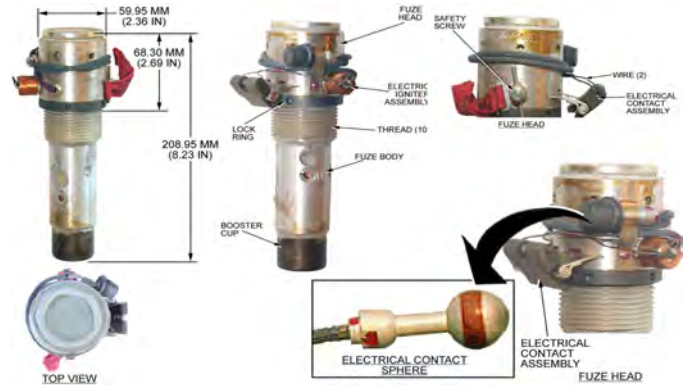

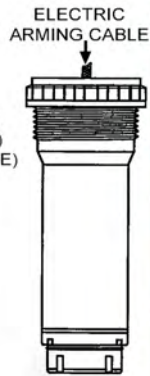
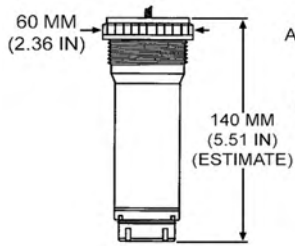

**U.S.S.R. BOMB FUZE, NOSE AND TAIL, IMPACT, AVB-E**

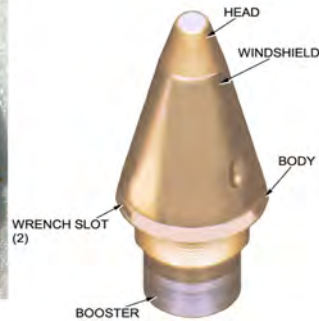
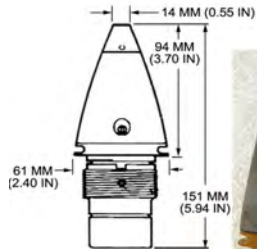

**PAKISTANI PROJECTILE FUZE, PD, PDM 557**

Ordnance used with:  
M125A1, BOOSTER  
M107, 155 MM, HE  
M107, 155 MM, HE  
M106, 203 MM, HE  
UNKNOWN, 105-MM, HE  
UNKNOWN, 105-MM, CARTRIDGE, HE  
UNKNOWN, 105-MM, SMOKE, WP

## U.S. PROJECTILE FUZE, PD, M557

Ordnance used with:

- M1, 105-MM, HE
- M101, 155 MM, HE (GUN)
- M104, 155 MM, SMOKE, WP OR FS
- M106, 8-INCH, HE
- M121, 155-MM, GAS, VX
- M121A1, 155-MM, GAS, VX OR GB
- M122, 155-MM, GAS, GB

N.E.W. 24.00 G

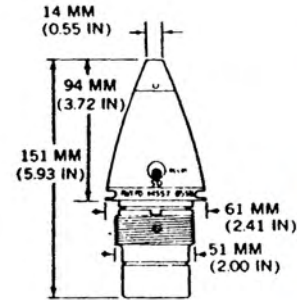

## U.S. PROJECTILE FUZE, PD, M557

Ordnance used with:

- M1, 105-MM, HE
- M101, 155 MM, HE (GUN)
- M104, 155 MM, SMOKE, WP OR FS
- M106, 8-INCH, HE
- M121, 155-MM, GAS, VX
- M121A1, 155-MM, GAS, VX OR GB
- M122, 155-MM, GAS, GB

N.E.W. 24.00 G

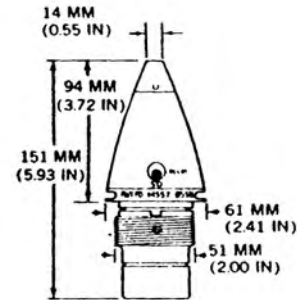

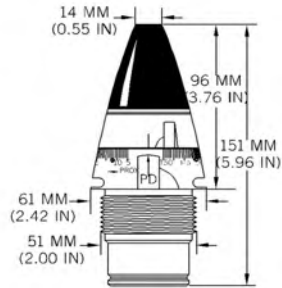

## U.S. PROJECTILE FUZE, PROXIMITY M732

Ordnance used with:

MK 81 MOD 0, 5-IN/54, HE-CVT, HI-FRAG

M1, 105-MM, HE

M106, 8-INCH, HE

M121A1, 155-MM, GAS, VX OR GB

M329, 4.2-IN (107-MM), HE

M329A1, 4.2-IN (107-MM), HE

M329A1E1, 4.2-IN (107-MM), HE

N.E.W. 5.96 G

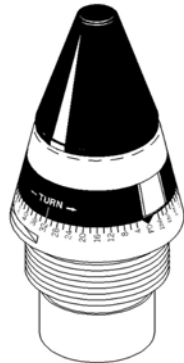
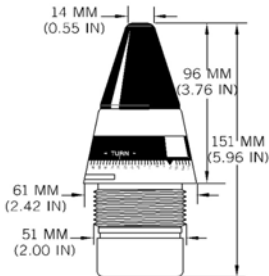

## U.S. PROJECTILE FUZE, PROXIMITY M732E2 (M732A2)

Ordnance used with:

M1, 105-MM, HE

M106, 8-INCH, HE

M121, 155-MM, GAS, VX

M329, 4.2-IN (107-MM), HE

M329A1, 4.2-IN (107-MM), HE

M329A1E1, 4.2-IN (107-MM), HE

M329A2, 4.2-IN (107-MM), HE

N.E.W. 28.00 G

## U.S. PROJECTILE FUZES, PD, MK 399 MODS 0 & 1, AND MK 407 MODS 0 & 1

Ordnance used with:

M60, 105-MM, CARTRIDGE, SMOKE, WP  
MK 166 MOD 0, 76-MM/62 CALIBER, HE-PD  
MK 58 MOD 0, PROJECTILE, 5-INCH/54, RAP  
MK 58 MOD 1, PROJECTILE, 5-INCH/54, RAP  
MK 283 MOD 0, 76MM, CARTRIDGE, HE-PD  
MK 55, PROJECTILE, 5 INCH/54, HE-CVT  
MK 64, PROJECTILE, 5 INCH/54, HE-CVT

N.E.W. 12.27 G

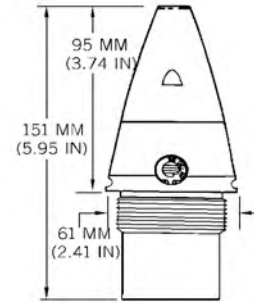

## U.S.S.R. BOMB FUZE, NOSE AND TAIL, AVU-E

Ordnance used with:

OFAB 100 120, BOMB, FRAG  
FAB-1500 M54, BOMB, GENERAL PURPOSE  
FAB-1500 M46, BOMB, GENERAL PURPOSE  
FAB-250 M-62, BOMB, GENERAL PURPOSE  
FAB-250 M54, BOMB, GENERAL PURPOSE  
FAB-250 SHN, BOMB, HE, RETARDED, 275 KG  
FAB-3000 M46, BOMB, GENERAL PURPOSE

N.E.W. 63.00 G

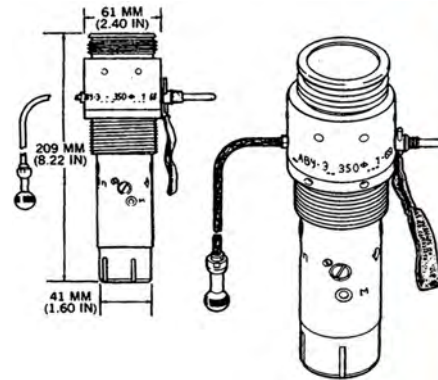

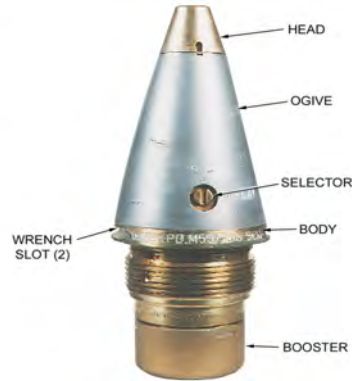
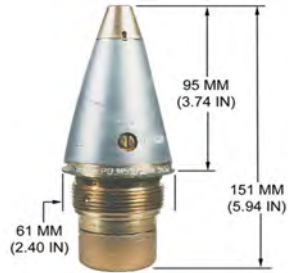

## YUGOSLAV PROJECTILE FUZE, PD, UTU M557

Ordnance used with:

- M1, 105-MM, HE
- M1, 105-MM, HE
- M84, 152-MM, HE
- M95, 122-MM, HE
- M60, 105-MM, CARTRIDGE, SMOKE WP
- 462, 122-MM, HE
- M1, CARTRIDGE, 105 MM, HE

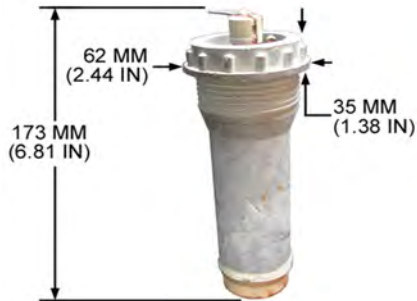

## U.S.S.R. BOMB FUZE, AVB-M

## U.S.S.R. BOMB FUZE, NOSE AND TAIL, AV-2 D/U

Ordnance used with:

FAB-1500 M54, BOMB, GENERAL PURPOSE  
FAB-1500 M46, BOMB, GENERAL PURPOSE  
FAB-250 M46, BOMB, GENERAL PURPOSE  
FAB-250 M54, BOMB, GENERAL PURPOSE  
FAB-250 SHN, BOMB, HE, RETARDED, 275 KG  
FAB-3000 M46, BOMB, GENERAL PURPOSE  
FAB-500T, BOMB, GENERAL PURPOSE

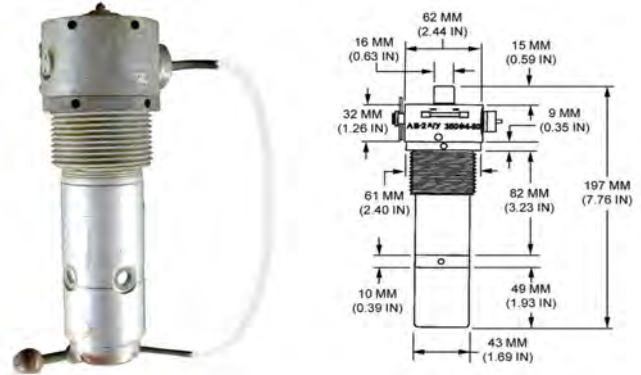

## CHINESE PROJECTILE FUZE, PROXIMITY (VT), MD-12A1

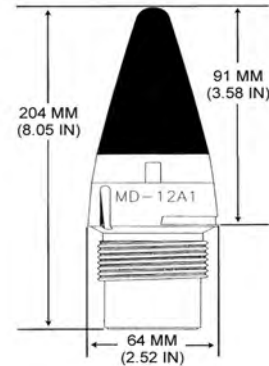

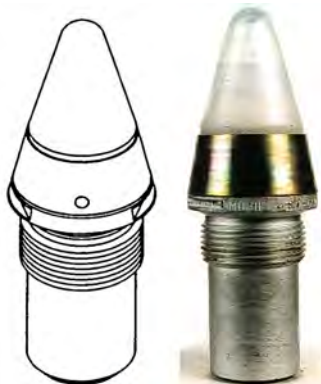
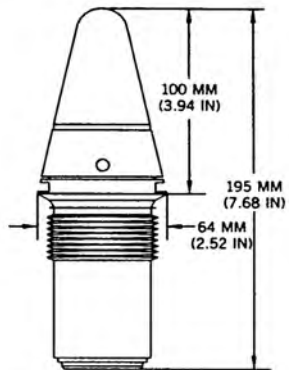

### CHINESE PROJECTILE FUZE, PROXIMITY/PD, MD-11

Ordnance used with:  
 TYPE 59, 130MM, HE  
 TYPE 66 MODIFIED, 152 MM, HE  
 TYPE 59 MODIFIED, PROJECTILE, 130-MM, HE

N.E.W. 13.82 G



### CHINESE PROJECTILE FUZE, PROXIMITY/PD, MD-12A

N.E.W. 80.02 G



## FRENCH ROCKET FUZE, PD, ALL-WAY ACTING, 156



N.E.W. 28.00 G

## FRENCH ROCKET FUZE, PD, S21



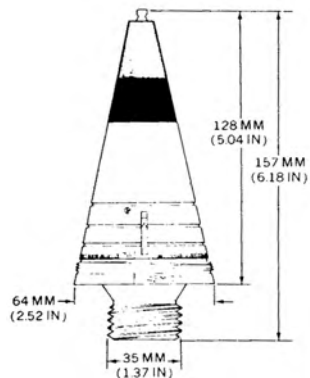

## GERMAN (PEOPLE'S REPUBLIC) ROCKET FUZE, PTT, MODEL T-7

Ordnance used with:  
 FLG-5000/M68, 116MM, ILLUMINATION  
 MDL. UNKNOWN, 116 MM, ILLUMINATION  
 ATI 5000, 116MM, DECOY, (AIR TARGET IMITATOR)  
 ATI 5000 (S), 116MM, DECOY (AIR TARGET IMITATOR)

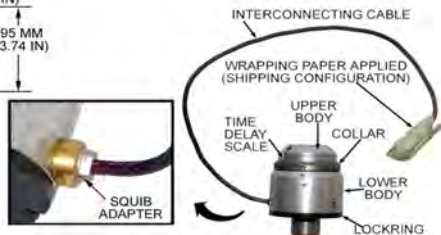
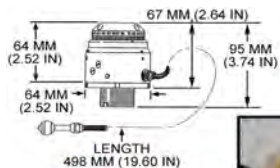

TOP VIEW



ELECTRIC CONTACT SPHERE



BOOSTER CUP

## U.S.S.R. BOMB FUZE, ATK-2A

# U.S.S.R. BOMB FUZE, ATK-EA

Ordnance used with:  
 RBK-250-275, DISP.  
 RBK-500 AO-2.5 RTM, CLUSTER BOMB

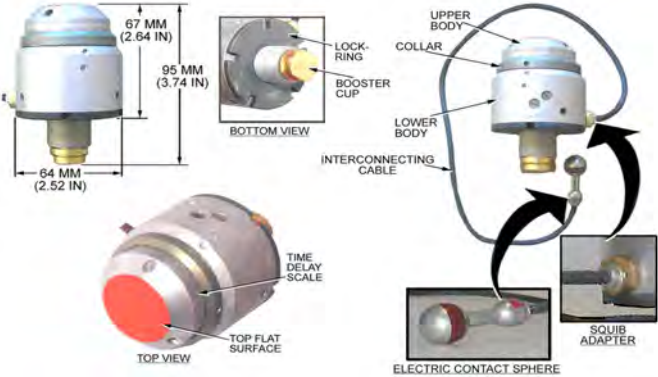

# U.S.S.R. BOMB FUZE, MT, ATK-2B

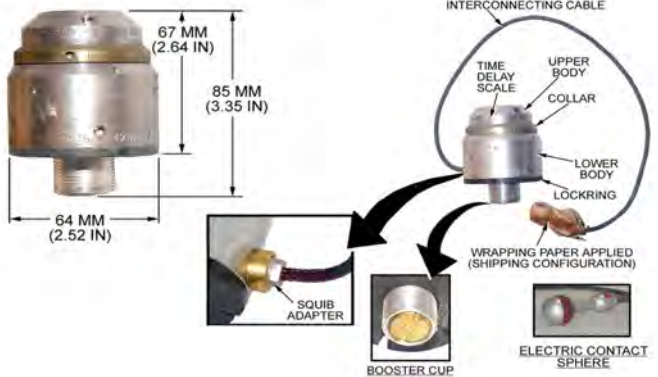

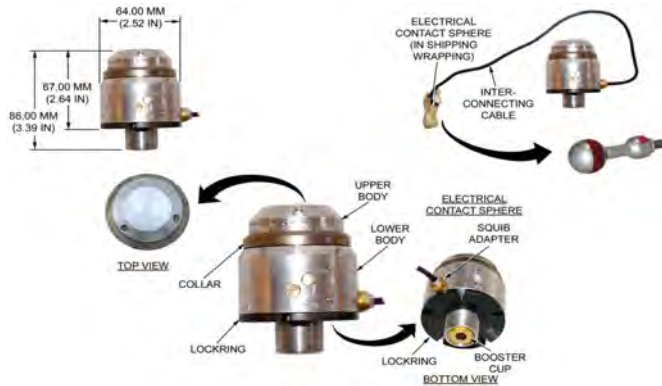

## U.S.S.R. BOMB FUZE, MT, ATK-EB

Ordnance used with:  
 RBK-250-275, DISP.  
 ZAB-50TG TYPE C, BOMB, INCENDIARY  
 PTAB-500-225, CLUSTER/DISPENSER  
 RBK-500-225, CLUSTER/DISPENSER  
 RBK-250, DISP.

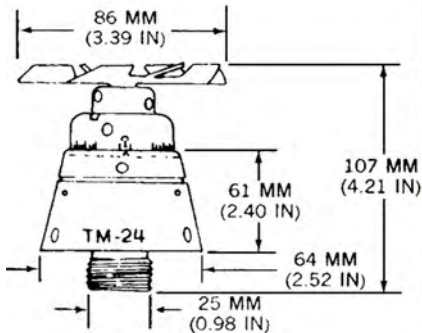

## U.S.S.R. BOMB FUZE, NOSE & TAIL, MT, TM-24A

Ordnance used with:  
 FAB 100 ZE, BOMB, HE, INCENDIARY  
 ZAB 100 TSHCH, CBU, INCENDIARY  
 ZAB 50T SHCH, CBU, INCENDIARY  
 PROSAB-250, CBU  
 BRAB-1000, BOMB, ARMOR PIERCING  
 FOTAB-100-80, BOMB, PHOTOFLASH  
 KHAB-25, BOMB, CHEMICAL

## U.S.S.R. BOMB FUZE, NOSE & TAIL, MT, TM-24B

Ordnance used with:  
FAB 100 ZE, BOMB, HE, INCENDIARY  
P 50 75, BOMB, PRACTICE  
ZAB 100 TSHCH, CBU, INCENDIARY  
ZAB 50T SHCH, CBU, INCENDIARY  
RBK-250, CLUSTER, ADAPTER  
RBK-250-275, DISP.  
RBK-500, DISP. (OLD STYLE)

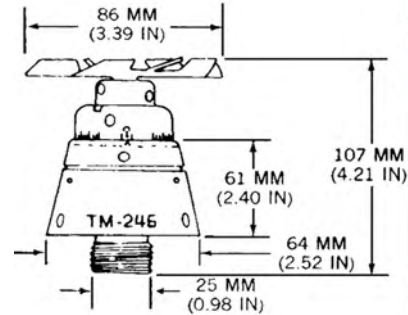

## U.S.S.R. BOMB FUZE, NOSE, AVR-5



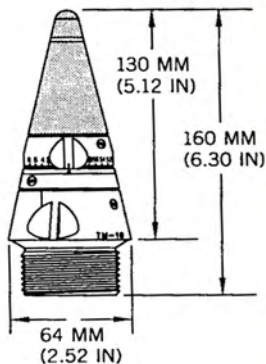

### U.S.S.R. PROJECTILE FUZE, MT, TM-16L

Ordnance used with:  
SP-46, 130-MM, ILLUMINATION

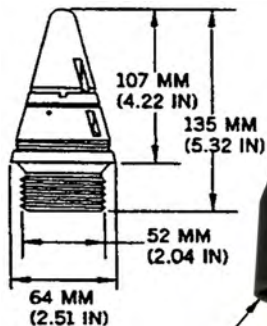

### U.S.S.R. PROJECTILE FUZE, MT, VM-30

Ordnance used with:  
O-415, 100-MM, FRAG  
O-415, 100-MM, HE-FRAG

N.E.W. 6.00 G

## U.S.S.R. PROJECTILE FUZE, MT, VM-30-L1

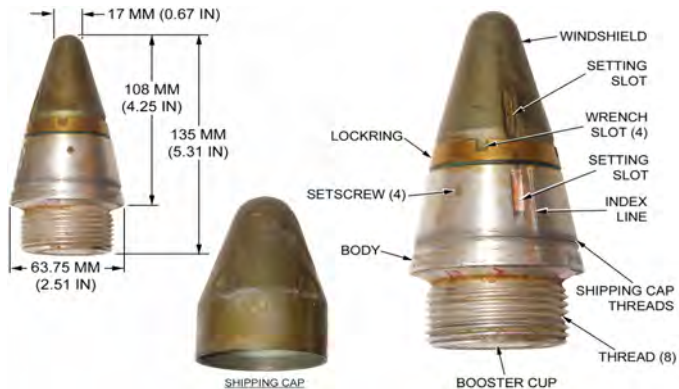

N.E.W. 58.68 G

## U.S.S.R. PROJECTILE FUZE, MT, VM-30L

Ordnance used with:  
 O-415, 100-MM, FRAG  
 O-415, 100-MM, HE-FRAG

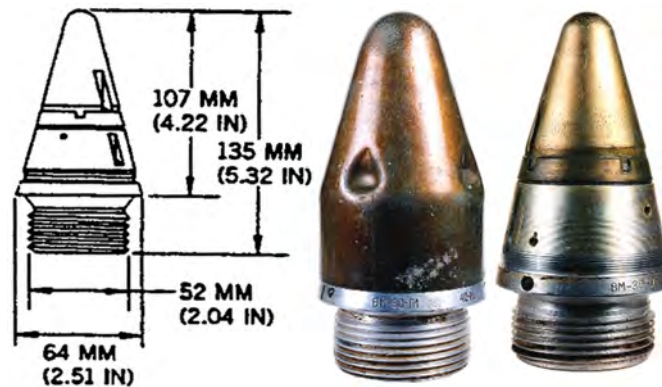

N.E.W. 6.00 G

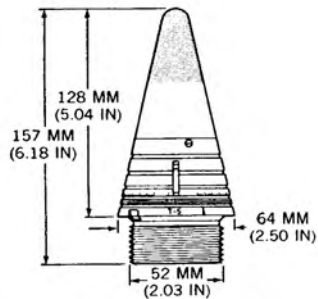

FUZE WITH SHIPPING CAP

## U.S.S.R. PROJECTILE FUZES, TIME, T-5 & T-11

Ordnance used with:

O-365, 85-MM, PROJECTILE, HE, (2 PIECE)

UO-365, 85-MM, CARTRIDGE, HE

UO-365K, 85-MM, CARTRIDGE, FRAG

M69, 85-MM, HE

O-365 (ONE-PIECE), 85-MM, HE-FRAG

N.E.W. 0.16 LB

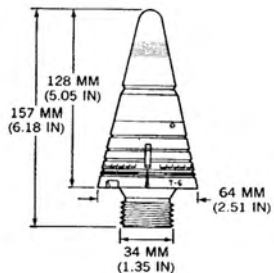

## U.S.S.R. PROJECTILE FUZES, TSQ, T-6; & TIME OR TSQ, T-7

Ordnance used with:

OS-464, 122-MM, ILLUM

A-462, 122-MM, PROPAGANDA

S-463, 122-MM, ILLUM

S-463ZH, 122-MM, ILLUM

SH-354G, 76-MM, SHRAPNEL

N.E.W. 10.00 G



## U.S.S.R. ROCKET FUZE, PD, DKZ-B

Ordnance used with:  
9M22M, 122 MM, HE-FRAG, 6 FOOT  
SAKR-10  
UNKNOWN, 122MM, HE, TWO-STAGE, S-TO-S



## U.S.S.R. ROCKET FUZE, PD, MRV

Ordnance used with:  
9M22M, 122 MM, HE-FRAG, 6 FOOT  
SAKR-10  
UNKNOWN, 122MM, HE, TWO-STAGE, S-TO-S

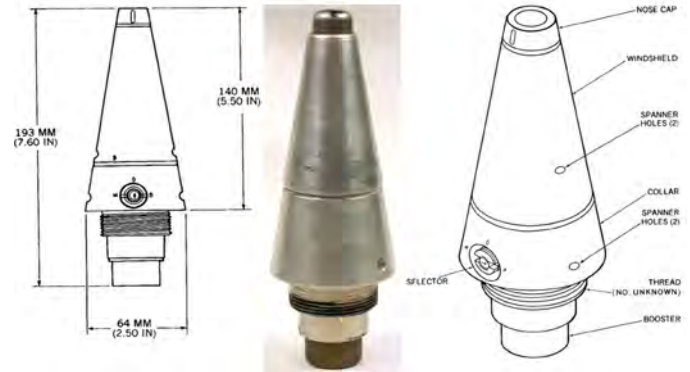

N.E.W. 88.00 G

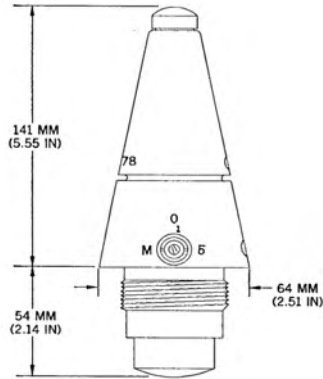

## U.S.S.R. ROCKET FUZE, PD, MRV-U

Ordnance used with:

9M22M, 122 MM, HE-FRAG, 6 FOOT

SAKR-10

9M22U, 122 MM, HE-FRAG, 9 FOOT

UNKNOWN, 122MM, HE, TWO-STAGE, S-TO-S

MDL UNK, WHD, 122 MM, CHEMICAL, NON-PERSISTANT

9M27F, 220MM, HE

9N128F, WARHEAD, 220MM, HE

N.E.W. 29.00 G

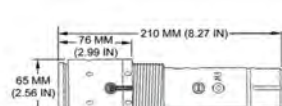

## U.S.S.R. BOMB FUZE, NOSE AND TAIL, IMPACT INERTIA, AVU-ET

Ordnance used with:

FAB 500, M62, BOMB, GP, 500 KG

OFAB 100 120, BOMB, FRAG

KAB-500KR, TV GUIDED

OFAB-250-270, BOMB, FRAGMENTATION

FAB-100 M80, BOMB, GP, 100 KG

UNKNOWN, GUIDANCE KIT

PF.K ZB-500SH, BOOSTER, INCENDIARY

N.E.W. 59.44 G

**AFGHAN FIRING DEVICE, ELECTRONIC DELAY,  
3/6/12 MINUTE, MODEL UNKNOWN**

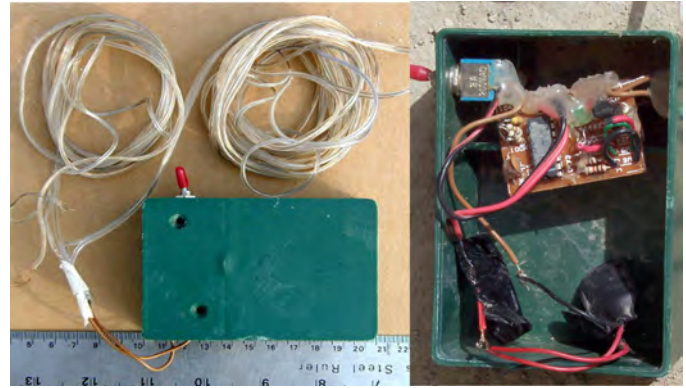

**U.S.S.R. BOMB FUZE, NOSE AND TAIL, IMPACT,  
AV 527**

Ordnance used with:  
ZAB 500 SH, BOMB, INCENDIARY, 500 KG  
RBK-500 BETAB, DISPENSER, BETAB, 500 KG  
RBK-500 PTAB-1M, CBU  
KP-527, EXPLOSIVE DISCONNECT/DEPLOYMENT MECHANISM  
RBK-500 AO-2.5 RTM, CLUSTER BOMB  
RBK-500 AO-2.5 RT, CBU  
RBK-500 ZAB 2.50SM, CBU

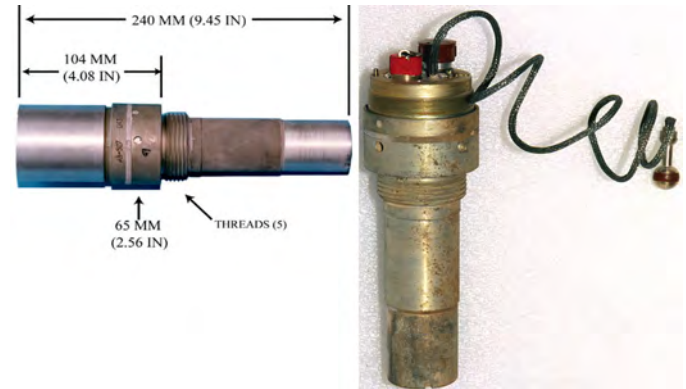

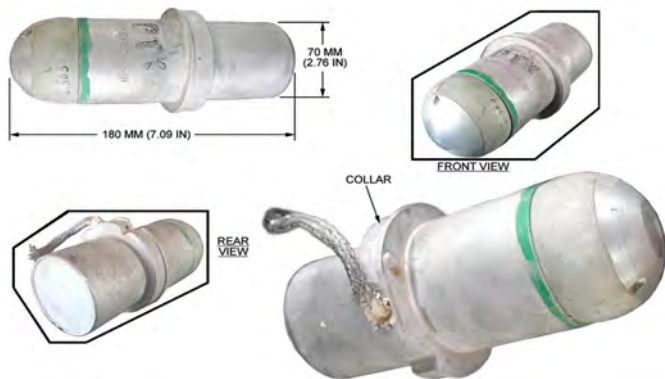

## U.S.S.R. BOMB FUZE, UP-581

Ordnance used with:  
FAB-500 SHN, GENERAL PURPOSE, 500 KG

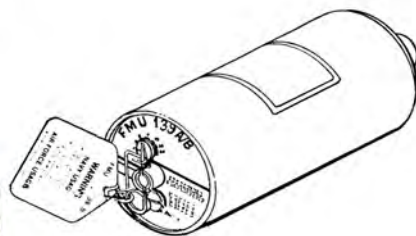
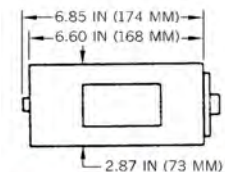

## U.S. BOMB FUZES, ELECTRONIC, NOSE AND/OR TAIL, IMPACT, FMU-139A/B AND FMU-139B/B

Ordnance used with:  
BLU-110A/B, BOMB, GPLD, 1,000 LB  
BLU-111A/B, BOMB, GPLD, 500 LB  
DSU-30/B, BOMB TARGET DETECTING DEVICE  
DSU-33A(D-2)/B, SENSING ELEMENT, DUMMY  
DSU-33A/B, SENSING ELEMENT, PROX.  
GBU-10/B, BOMB UNIT, GUIDED  
GBU-10A/B, BOMB UNIT, GUIDED

N.E.W. 129.00 G

## U.S.S.R. ROCKET FUZE, PROXIMITY, RV-24

Ordnance used with:  
S-24, 240-MM, FIXED FIN, HE, A-TO-S

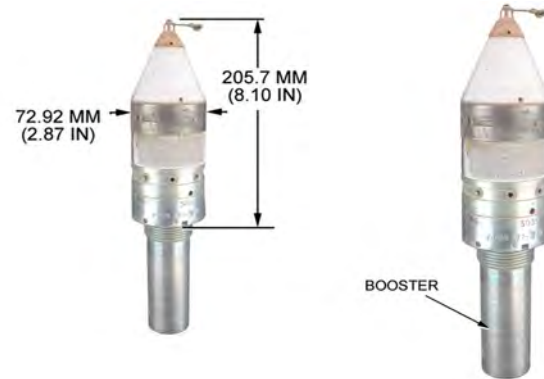

---

## U.S. PROJECTILE FUZE, PD, FMU-153/B

Ordnance used with:  
M1 (MOD), CARTRIDGE, 105MM, HE  
M1 (MOD), PROJECTILE, 105MM, HE  
HF M1 (MOD), CARTRIDGE, 105MM, HE  
HF M1 (MOD), 105MM, HE



---

N.E.W. 12.27 G

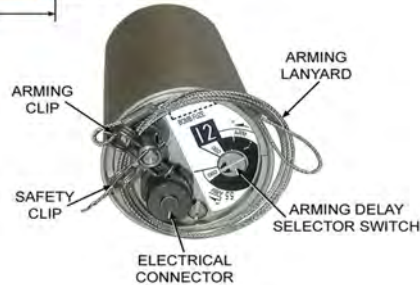
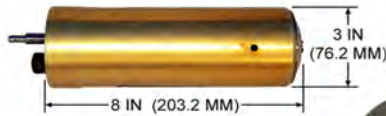

## U.S. BOMB FUZE, NOSE AND TAIL, IMPACT, FMU-143J/B

Ordnance used with:  
 GBU-24/B, BOMB UNIT, GUIDED  
 GBU-24A/B, BOMB UNIT, GUIDED  
 BLU-118/B, PENETRATOR, 2000 LB, THERMOBARIC

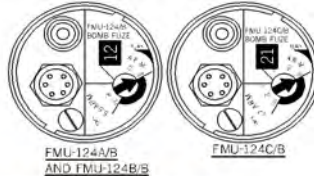
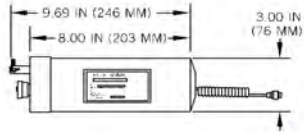

## U.S. BOMB FUZES, NOSE & TAIL, IMPACT, FMU-124A/B, FMU-124B/B, AND FMU-124C/B

Ordnance used with:  
 GBU-15(V)1/B  
 AGM-142A, AIR-TO-GROUND HAVE NAP  
 AGM-142B, AIR-TO-GROUND HAVE NAP  
 AGM-142C, AIR-TO-GROUND HAVE NAP  
 N.E.W. 133.00 G



**U.S. BOMB FUZES, NOSE & TAIL, IMPACT, FMU-143/B,  
FMU-143A/B, FMU-143B/B, FMU-143D/B, FMU-143E/B,  
FMU-143F/B, FMU-143G/B & FMU-143H/B**

Ordnance used with:  
 BLU-113/B, PENETRATOR  
 BLU-113A/B, PENETRATOR  
 GBU-10C/B, BOMB UNIT, GUIDED  
 GBU-10G/B, BOMB UNIT, GUIDED  
 GBU-15(V)2/B  
 GBU-15(V)31/B, BOMB UNIT, GUIDED  
 GBU-15(V)32/B, BOMB UNIT, GUIDED  
 N.E.W. 133.00 G

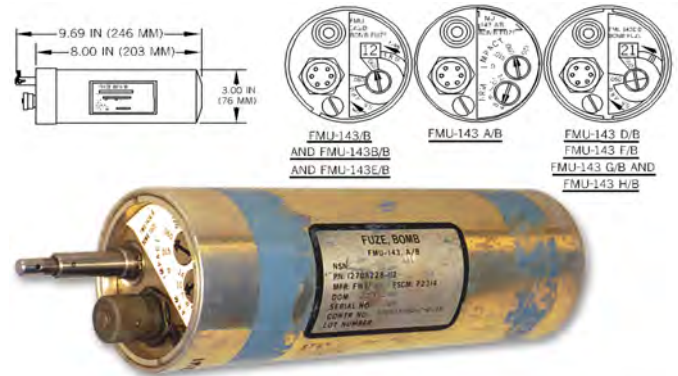

**U.S. PROJECTILE FUZE, PD, MK407 MOD 1 (HIP)**

Ordnance used with:  
 M1, 105-MM, HE  
 M1 (MOD), CARTRIDGE, 105MM, HE  
 M1 (MOD), PROJECTILE, 105MM, HE

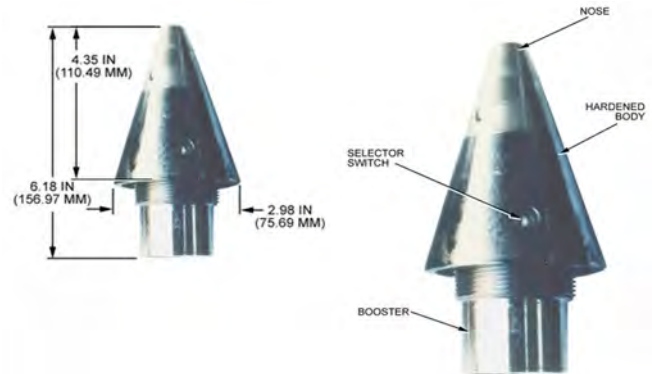

N.E.W. 12.27 G

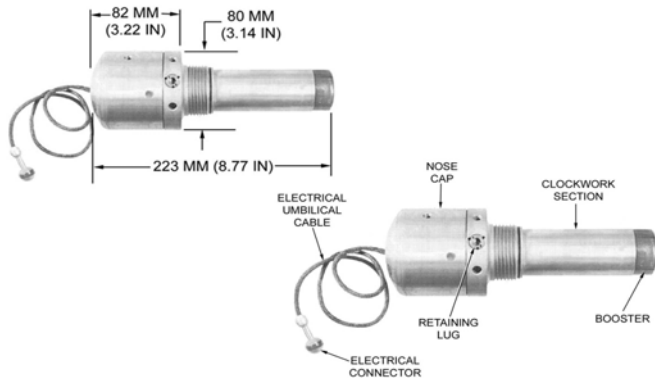

## U.S.S.R. BOMB FUZE, NOSE AND TAIL, LONG DELAY, ANTIDISTURBANCE, AVPZ

Ordnance used with:  
 FAB-1500 M54, BOMB, GENERAL PURPOSE  
 FAB-3000 M54, GENERAL PURPOSE  
 MDL. UNKNOWN, BATTERY, 47 VOLTS, FOR AVPZ BOM...

N.E.W. 50.00 G

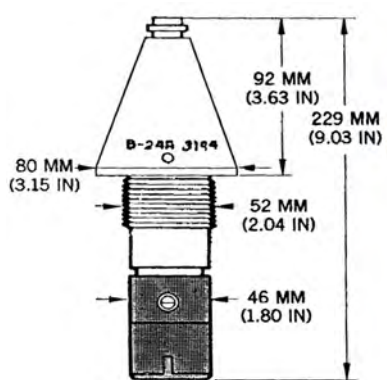

## U.S.S.R. ROCKET FUZE, NOSE, PD, V-24A

Ordnance used with:  
 F-961, 240 MM, SPIN STABILIZED, HE, S-TO-S  
 F-961U, 240 MM, SPIN STABILIZED, HE, S-TO-S  
 S-24, 240-MM, FIXED FIN, HE, A-TO-S



## U.S. PROJECTILE FUZE, MTSQ, M772

Ordnance used with:  
M721, CARTRIDGE, 60-MM, ILLUMINATING  
M-819, 81-MM, CARTRIDGE, SMOKE, RP, MORTAR  
M819, 81-MM, CARTRIDGE, SMOKE, RP, MORTAR  
M853A1 CARTRIDGE, 81-MM, ILLUM  
M853A1, 81MM, ILLUM  
M721, PROJECTILE, 60-MM, MORTAR, ILLUMINATING  
M-819, 81-MM, SMOKE, RP, MORTAR

N.E.W. 6.00 G

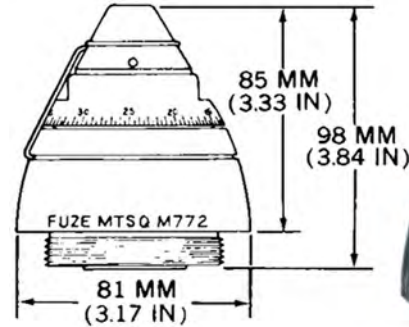

## SWEDISH PROJECTILE FUZE, MT, FFV 447

Ordnance used with:  
FFV 441B, 84-MM, CARTRIDGE, HE-FRAG  
FFV 441B, 84-MM, HE-FRAG

N.E.W. 5.05 G

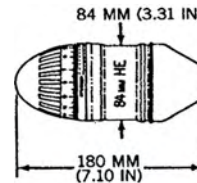

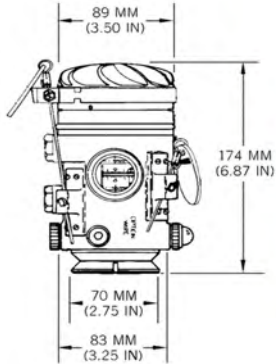

### U.S. BOMB FUZE, NOSE, MT, MK 339 MOD 0

Ordnance used with:  
 MJU-1/B, 750 LB, CNTRMSRS (CHAFF)  
 MK 7 MOD 2, DISP.  
 MK 7 MOD 3, DISP.  
 MK 7 MOD 4, DISP.  
 MK 7 MOD 6, DISP.  
 SUU-30A/B, DISP.  
 SUU-30B/B, DISP.  
 N.E.W. 6.00 G

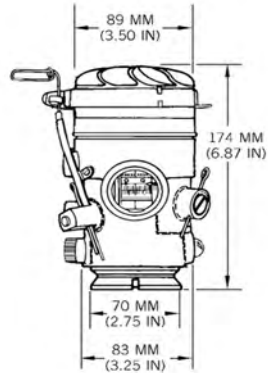

### U.S. BOMB FUZE, NOSE, MT, MK 339 MOD 1

Ordnance used with:  
 MJU-1/B, 750 LB, CNTRMSRS (CHAFF)  
 MK 7 MOD 2, DISP.  
 MK 7 MOD 3, DISP.  
 MK 7 MOD 4, DISP.  
 MK 7 MOD 6, DISP.  
 SUU-30/B, DISP.  
 SUU-30A/B, DISP.  
 N.E.W. 0.27 G

## U.S. BOMB FUZE, NOSE, M904E4

Ordnance used with:

M117A3

BLU-110A/B, BOMB, GPLD, 1,000 LB

BLU-111A/B, BOMB, GPLD, 500 LB

BLU-82/B, BOMB UNIT, BLAST, CRADLED

M117, 750 LB, GP

M117A1, 750 LB, GP

M117A1E1, 750 LB, GP

N.E.W. 75.00 G

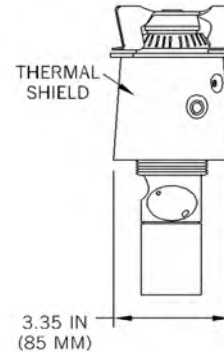

## U.S. BOMB FUZES, NOSE, M904E1, M904E2, AND M904E3

Ordnance used with:

M117A3

BLU-110A/B, BOMB, GPLD, 1,000 LB

BLU-111A/B, BOMB, GPLD, 500 LB

BLU-82/B, BOMB UNIT, BLAST, CRADLED

M117, 750 LB, GP

M117A1, 750 LB, GP

M117A1E1, 750 LB, GP

N.E.W. 75.00 G

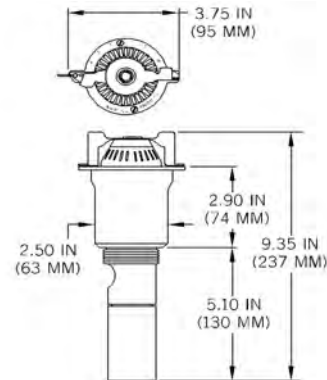

M904E1 (SHOWN)

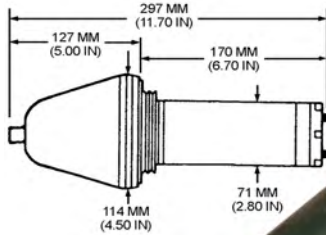

## U.S. BOMB TARGET DETECTING DEVICE, MK 43 MOD 0

Ordnance used with:  
 FMU-54A/B, BOMB FUZE, TAIL  
 M117, 750 LB, GP  
 M117A1, 750 LB, GP  
 M117A1E2, 750 LB, GP  
 M117A1E3, 750 LB, GP  
 M117A2, 750 LB, GP  
 M990, BOMB FUZE, TAIL, ELEC.

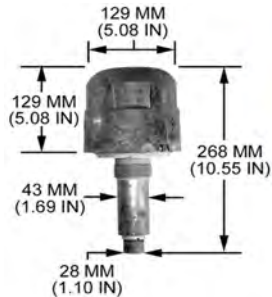

TOP VIEW  
WITH NOSE CAP  
REMOVED



## U.S.S.R. BOMB FUZE, NOSE, PROXIMITY, 9-A-798

## U.S. BOMB SENSING ELEMENT, PROXIMITY, DSU-33A/B

Ordnance used with:  
BLU-110A/B, BOMB, GPLD, 1,000 LB  
BLU-111A/B, BOMB, GPLD, 500 LB  
FMU-139/B, NOSE & TAIL, IMPACT  
FMU-139A/B, NOSE & TAIL, IMPACT  
M117, 750 LB, GP  
M117A1, 750 LB, GP  
M117A1E1, 750 LB, GP

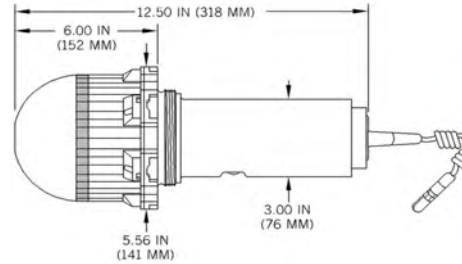

## AFGHAN KIT, FIRING DEVICE, RADIO CONTROLLED, MODEL UNKNOWN

Ordnance used with:  
MDL. UNKNOWN, TRANSMITTER, RADIO CONTROLLED (RC)  
MDL. UNKNOWN, RECEIVER, RADIO CONTROLLED (RC)





### U.S.S.R. ANTILIFT DEVICE, MS-3

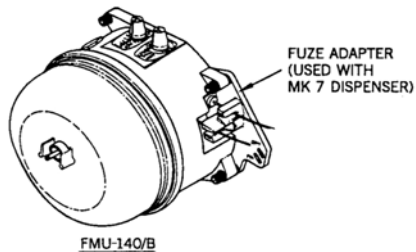
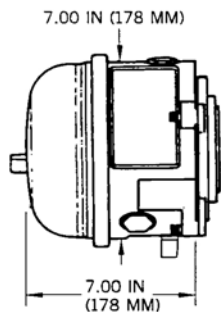

### U.S. BOMB FUZE, NOSE, PROXIMITY, FMU-140/B

Ordnance used with:  
MK 7 MOD 2, DISP.  
MK 7 MOD 3, DISP.  
MK 7 MOD 4, DISP.  
MK 7 MOD 6, DISP.  
SUU-58/B, DISP.  
APAM CLUSTER WEAPON  
CBU-59/B  
N.E.W. 608.33 MG

## U.S. BOMB FUZE, NOSE, PROXIMITY, FMU-140A/B

Ordnance used with:  
MK 7 MOD 2, DISP.  
MK 7 MOD 3, DISP.  
MK 7 MOD 4, DISP.  
MK 7 MOD 6, DISP.  
SUU-58/B, DISP.  
APAM CLUSTER WEAPON  
CBU-59/B

N.E.W. 608.33 MG

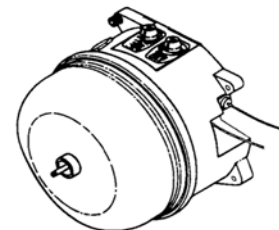
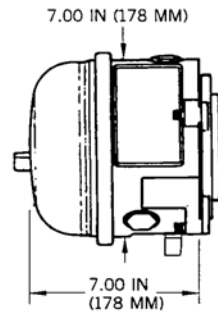

FMU-140A/B

***THIS PAGE INTENTIONALLY LEFT BLANK***



## BULGARIAN CARTRIDGE, 100-MM, HEAT, UBK-4

Ordnance used with:  
GPV-2, PROJECTILE, PIBD, SPITBACK  
AP.HC4.5CU, 100MM, HEAT-FS-T  
APHC5CU, 100MM, HEAT-FS-T  
BK-5, 100MM, HEAT-FS-T

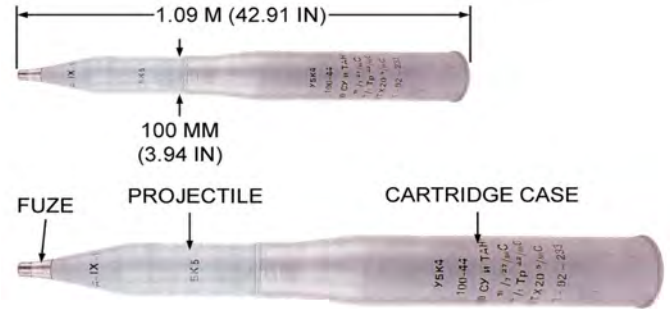

## U.S.S.R. CARTRIDGE, 115-MM, APFSDS-T, UBM-9

Ordnance used with:  
3BM21, 115-MM, APFSDS  
BM-21, 115-MM, APFSDS

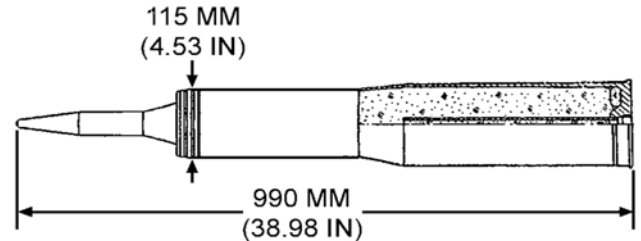

## U.S.S.R. CARTRIDGE, 122 MM, HE-FRAG, VOF-462A



Ordnance used with:  
OF-462A, 122-MM, HE, FRAG  
ZH-463, 122MM, PROPELLING CHARGE

---

## U.S.S.R. CARTRIDGE, 37-MM, AP-T, BZT



Ordnance used with:  
BZT, 37-MM, AP-T

## U.S.S.R. PROJECTILE, 115-MM, APFSDS-T, BM-21

Ordnance used with:  
3UBM9, CARTRIDGE, 115-MM, APFSDS  
UBM-9, CARTRIDGE, 115-MM, APFSDS

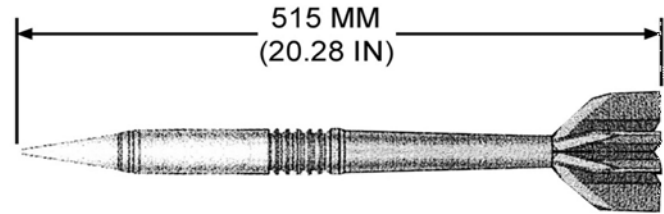

---

## YUGOSLAV CARTRIDGE, 100-MM, HEAT-T, M69

Ordnance used with:  
AU-16, PROJECTILE, PIBD  
M69, PROJECTILE, PIBD  
UT PE M69, PROJECTILE, PIBD  
UT-PE.M69, PROJECTILE, PIBD  
M69, 100-MM, HEAT-T

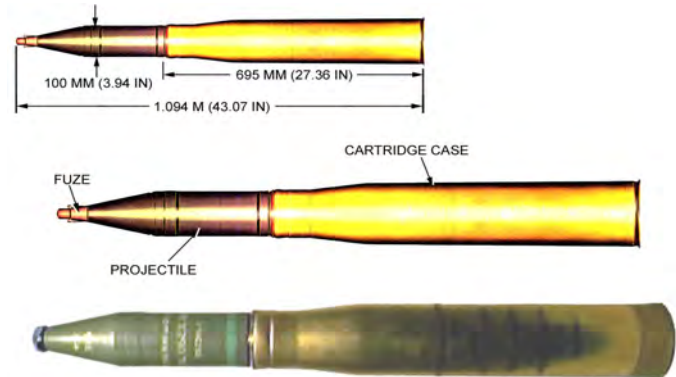

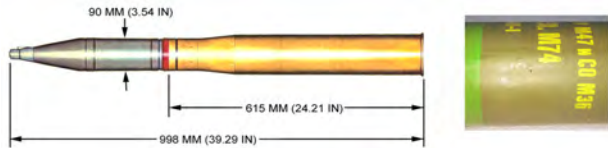

## YUGOSLAV CARTRIDGE, 90-MM, HEAT-T, M74

Ordnance used with:  
M74, 90-MM, HEAT-T  
AU-16, PROJECTILE, PIBD  
M69, PROJECTILE, PIBD  
UT PE M69, PROJECTILE, PIBD  
UT-PE.M69, PROJECTILE, PIBD



## SWISS PROJECTILE, 20-MM, APHEI-T (PSBLH/B)

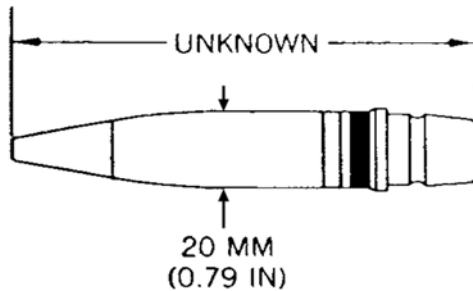

Ordnance used with:  
PSBLH/B, CARTRIDGE, 20-MM, APHEI-T  
BZ-0144, PROJECTILE, BD

## BULGARIAN PROJECTILE, 23-MM, HEI-T, OFZT

Ordnance used with:  
MG-25, PROJECTILE, PDSO  
OFZT, CARTRIDGE, 23MM, HEI-T

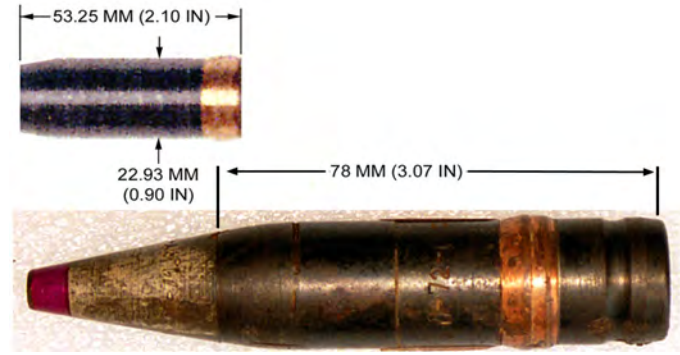

## CHINESE IGNITION CARTRIDGE, 82-MM, MORTAR, MODEL UNKNOWN

Ordnance used with:  
TH521, 82-MM, HE  
TYPE 53, 82-MM, HE  
TYPE 53, 82 MM, SMOKE, WP  
TYPE 53, 82MM, ILLUM, MORTAR  
UNKNOWN, 82 MM, MORTAR, ILLUM  
TYPE 53, 82MM, CARTRIDGE, HE, MORTAR



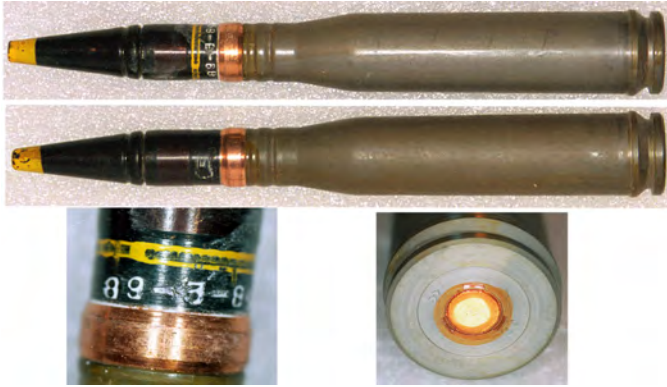

## U.S.S.R. CARTRIDGE, 23-MM, API-T, BZT

Ordnance used with:

BZT, 23-MM, API-T

ZUR-23-2S, GUN/MISSILE AIR DEFENSE SYSTEM, 23...

ZU-23, AIR DEFENSE GUN, 23MM, TWIN, TOWED

ZSU-23-4, AIR DEFENSE GUN, 23MM, QUAD, SELF-P...

SKYWIPE, AIR DEFENSE GUN, 23MM, TWIN, TOWED

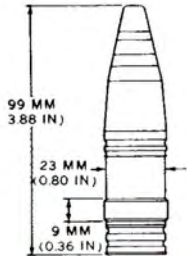

## U.S.S.R. PROJECTILE, 23-MM, API, BZA-23



## U.S.S.R. PROJECTILE, 23-MM, API-T, BZT

Ordnance used with:  
BZT, 23MM X 152BMM, CARTRIDGE, API-T

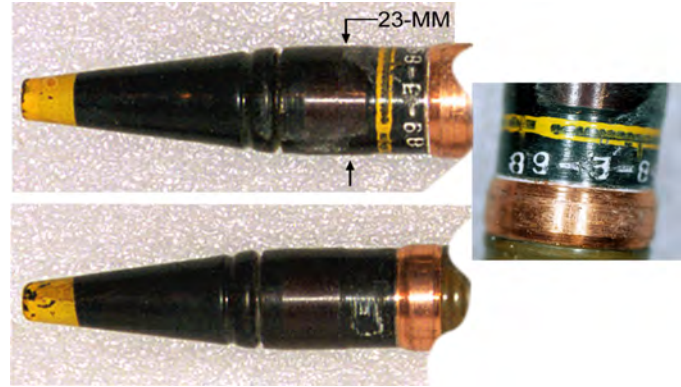

## U.S.S.R. PROJECTILE, 23-MM, FRAG-HEIT, OFZT

Ordnance used with:  
OFZT, CARTRIDGE, 23MM X 152MM, FRAG-HEIT  
B-23A, FUZE, PROJECTILE, PD  
MG-25, FUZE, PROJECTILE, PDS  
OFZT, 23-MM, CARTRIDGE, HEI-T  
OFZT, 23MM X 115MM, CARTRIDGE, HEI-T  
B-23M, PROJECTILE, PD

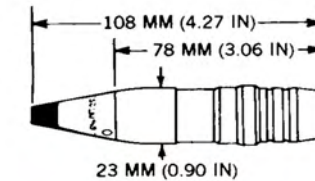

N.E.W. 13.00 G

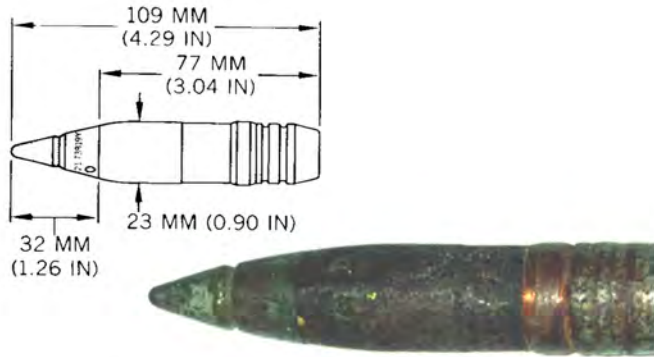

### U.S.S.R. PROJECTILE, 23-MM, HEI-FRAG, OFZ

Ordnance used with:  
 V-19U, PROJECTILE, PDSD  
 OFZ, CARTRIDGE, 23-MM, HEI, (23MM X 152MM)  
 V19UK, PROJECTILE, PDSD  
 B-23M, PROJECTILE, PD

N.E.W. 19.00 G

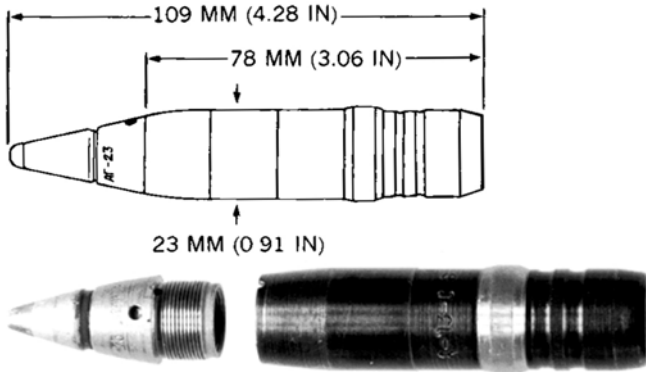

### U.S.S.R. PROJECTILE, 23-MM, FRAG-HEI, OFZ

Ordnance used with:  
 OFZ, CARTRIDGE, 23-MM, HEI (23MM X 115MM)  
 AG-23, PROJECTILE, PD



## U.S. CARTRIDGE, 25-MM, HEI, PGU-25/U

Ordnance used with:  
M505A3, PROJECTILE, PDSQ

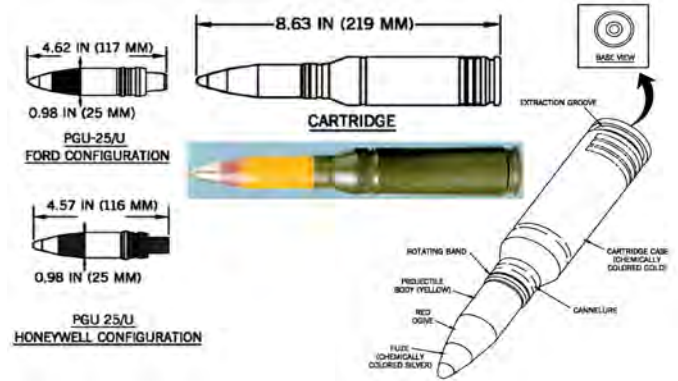

N.E.W. 131.00 G

## U.S. CARTRIDGE, 25-MM, HEI, PGU-25A/U

Ordnance used with:  
M505A3, PROJECTILE, PDSQ

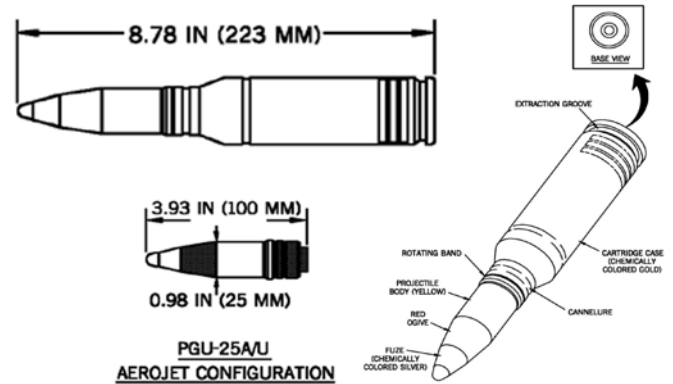

N.E.W. 131.00 G

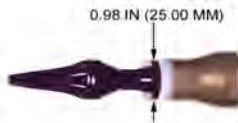
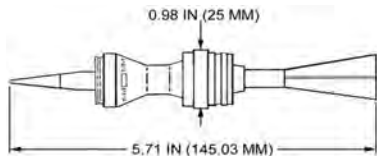

## U.S. PROJECTILE, 25-MM, APFSDS-T, M919 (2ND MODIFIED)

Ordnance used with:  
M919, 2ND MODIFIED, CARTRIDGE, 25MM, APFSDS-T

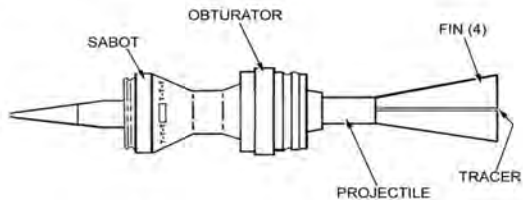

N.E.W. 2.00 G

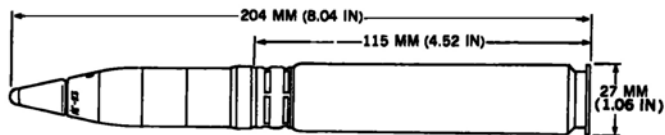

## U.S.S.R. CARTRIDGE, 23-MM, FRAG-HEI, OFZ

Ordnance used with:  
AG-23, PROJECTILE, PD  
OFZ, 23-MM, FRAG-HEI



## U.S.S.R. CARTRIDGE, 23-MM, HEI-T, OFZT

Ordnance used with:  
B-23A, FUZE, PROJECTILE, PD  
OFZT, 23-MM, HEI-T

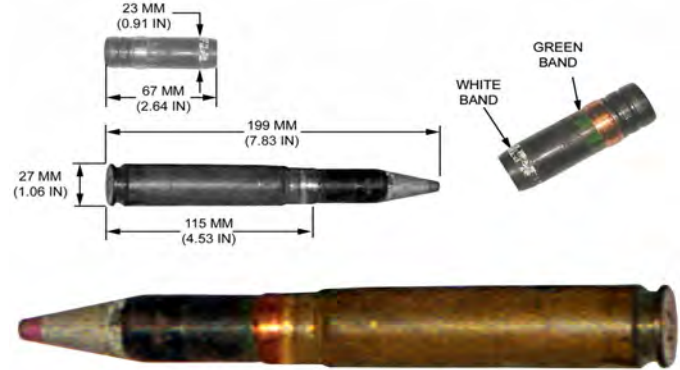

---

## RUSSIAN CARTRIDGE, 30-MM, HEI, OFZ

Ordnance used with:  
A-30U, PROJECTILE, PD

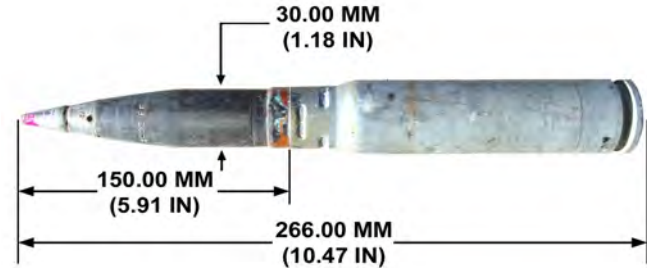

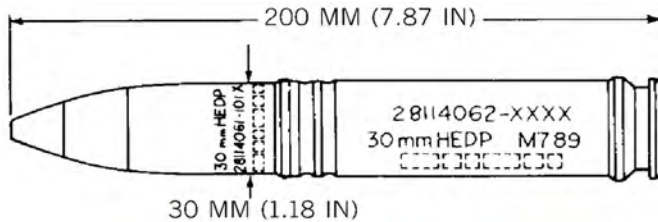

### U.S. CARTRIDGE, 30-MM, HEDP, M789

Ordnance used with:  
M789, 30-MM, HEDP  
M759, PROJECTILE, GRAZE-SENTITIVE PD  
PA520, ELEC. PRIMER

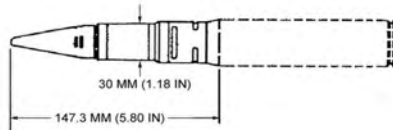

### U.S.S.R. PROJECTILE, 30-MM, AP-T, BT-30

Ordnance used with:  
BT-30, 30MM X 165MM, CARTRIDGE, AP-T



## U.S.S.R. PROJECTILE, 30-MM, APHEI, OFT WITH BD-30 FUZE

Ordnance used with:  
BD-30, PROJECTILE, BD  
CARTRIDGE, 30MM X 156B, BR-30, APHEI

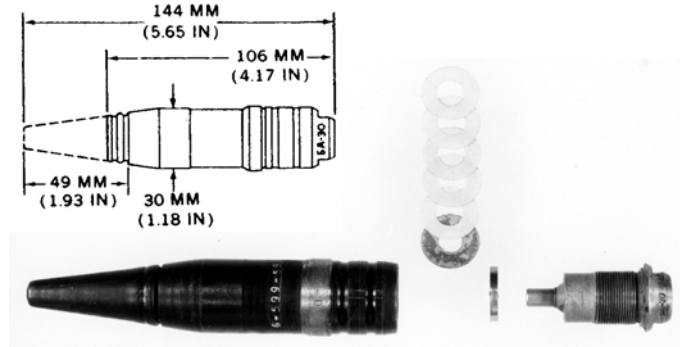

N.E.W. 16.00 G

## U.S.S.R. PROJECTILE, 30-MM, APHEI, OFT WITH BDM-30 FUZE

Ordnance used with:  
BDM-30, PROJECTILE, BD  
OFT, CARTRIDGE, 30-MM, APHEI (CURRENT)

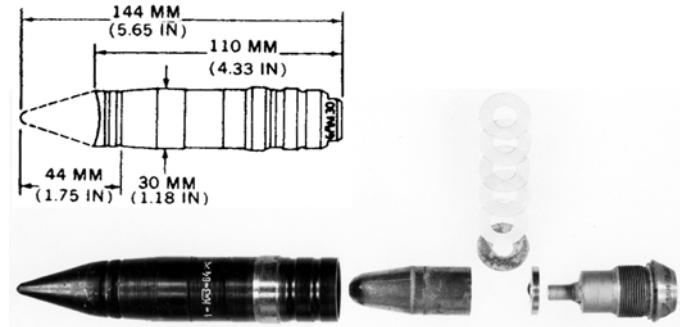

N.E.W. 26.00 G

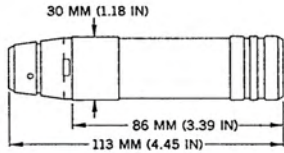

## U.S.S.R. PROJECTILE, 30-MM, FRAG, VOG-17M

Ordnance used with:  
VMG, PROJECTILE, PD  
7P9M, CARTRIDGE, 30MM, FRAG  
VOG-17M, CARTRIDGE, 30MM, FRAG  
VMG-M, PROJECTILE, PDS

N.E.W. 33.23 G

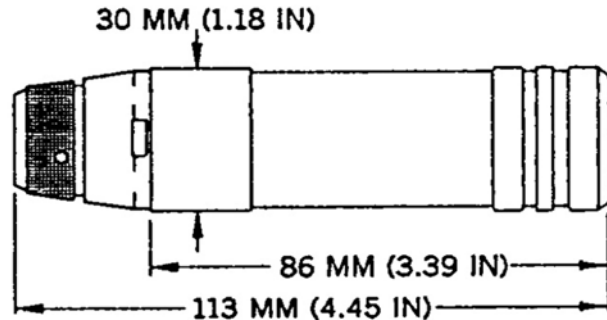

## U.S.S.R. PROJECTILE, 30-MM, FRAG, VOG-26

Ordnance used with:  
VOG-26, 30-MM, CARTRIDGE, FRAG  
VMG, PROJECTILE, PD  
VMG-M, PROJECTILE, PDS

N.E.W. 33.00 G

## U.S.S.R. PROJECTILE, 30-MM, FRAG-HEI, MODEL UNKNOWN

Ordnance used with:

A-670M, PROJECTILE, PDS

A670M, PROJECTILE, PDS

MG-32, PROJECTILE, PDS

MG32, PROJECTILE, PDS

OFZ, 30MM X 165MM, CARTRIDGE, HEI

UOF-84, 30MM X 165MM, CARTRIDGE, HEI

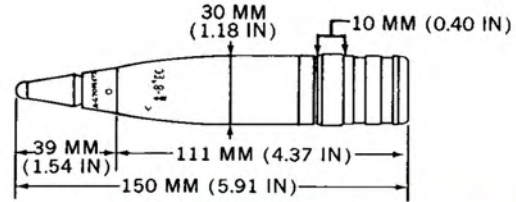

## U.S.S.R. PROJECTILE, 30-MM, FRAG-HEI, OFZ

Ordnance used with:

A-30, PROJECTILE, PD

B-30, PROJECTILE, PDS

A-30U, PROJECTILE, PD

OFZ, 30-MM, CARTRIDGE, HEI

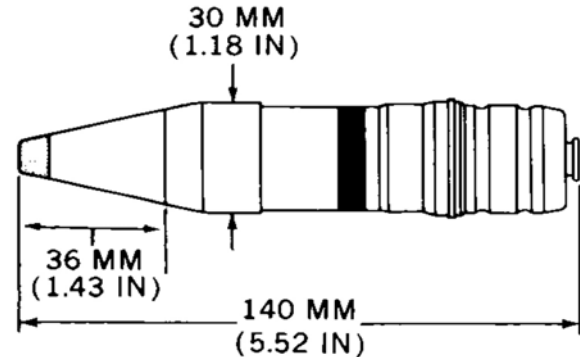

N.E.W. 47.00 G

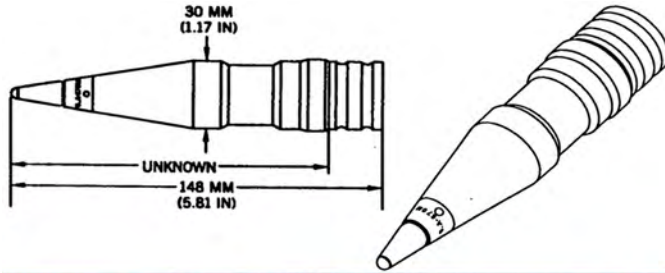

## U.S.S.R. PROJECTILE, 30-MM, HEI-T, OT

Ordnance used with:  
 A-670M, PROJECTILE, PDS  
 A670M, PROJECTILE, PDS  
 MG-32, PROJECTILE, PDS  
 MG32, PROJECTILE, PDS  
 FT, 30-MM, CARTRIDGE, HE-T  
 OT, 30-MM, CARTRIDGE, HE-T  
 OT-30, 30-MM, CARTRIDGE, HE-T  
 N.E.W. 38.00 G

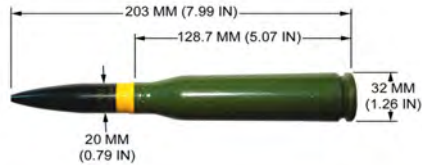

## ITALIAN CARTRIDGE, 20-MM, SAPHEI, MODEL UNKNOWN

Ordnance used with:  
 UNKNOWN, 20MM, SAPHEI  
 UNKNOWN, PROJECTILE, BDS



## U.S.S.R. CARTRIDGE, 30-MM, FRAG, VOG-17M (7P9M)

Ordnance used with:  
VMG, PROJECTILE, PD  
VMG-M, PROJECTILE, PSD  
7P9M, 30-MM, FRAGMENTATION  
VOG-17M, 30-MM, FRAGMENTATION

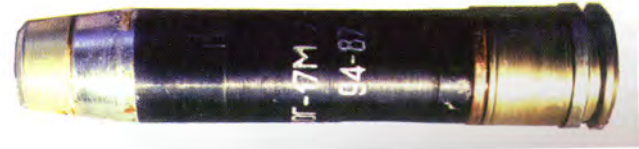
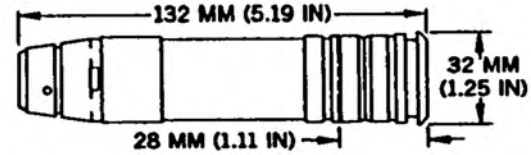

## U.S.S.R. CARTRIDGE, 30-MM, FRAG, VOG-26

Ordnance used with:  
VMG, PROJECTILE, PD  
VMG-M, PROJECTILE, PSD  
VOG-26, 30-MM, FRAGMENTATION

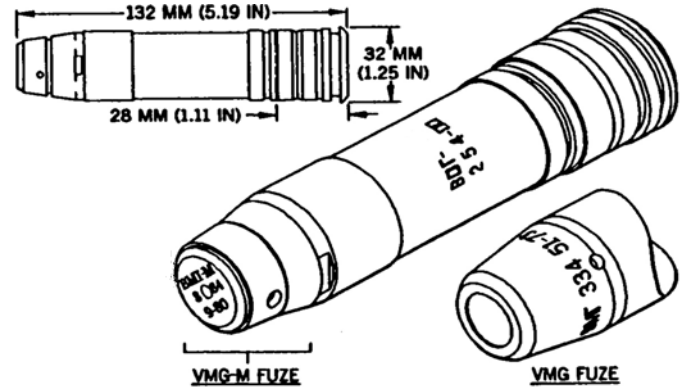



## BULGARIAN CARTRIDGE, 23MM, HEI-T, OFZT

Ordnance used with:  
 OFZT, 23MM, HEI-T  
 MG-25, PROJECTILE, PDS

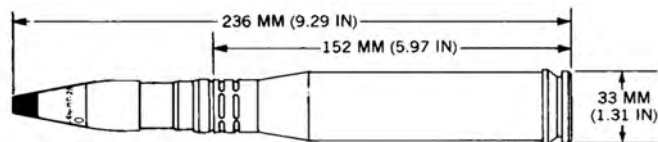

## U.S.S.R. CARTRIDGE, 23-MM, FRAG-HEIT, OFZT

Ordnance used with:  
 MG-25, FUZE, PROJECTILE, PDS  
 OFZT, 23MM, FRAG-HEIT  
 OFZT, 23-MM, HEI-T  
 ZUR-23-2S, GUN/MISSILE AIR DEFENSE SYSTEM, 23...  
 ZU-23, AIR DEFENSE GUN, 23MM, TWIN, TOWED  
 ZSU-23-4, AIR DEFENSE GUN, 23MM, QUAD, SELF-P...  
 SKYWIFE, AIR DEFENSE GUN, 23MM, TWIN, TOWED

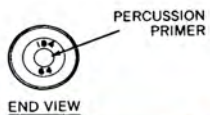

## U.S.S.R. CARTRIDGE, 23-MM, HEI-FRAG, OFZ

Ordnance used with:  
V-19U, PROJECTILE, PDSD  
OFZ, 23-MM, HEI  
V19UK, PROJECTILE, PDSD  
ZU-23, AIR DEFENSE GUN, 23MM, TWIN, TOWED  
ZSU-23-4, AIR DEFENSE GUN, 23MM, QUAD, SELF-P...  
SKYWIPE, AIR DEFENSE GUN, 23MM, TWIN, TOWED

N.E.W. 103.00 G

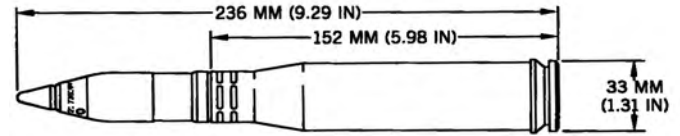

## GERMAN (FEDERAL REPUBLIC), CARTRIDGE, 27-MM X 145, HEI, DM21

Ordnance used with:  
DM 351, PROJECTILE, PDSD  
DM 341, PROJECTILE, PD  
DM 21, 27MM, HEI  
DM 401, PROJECTILE, PD

N.E.W. 108.00 G

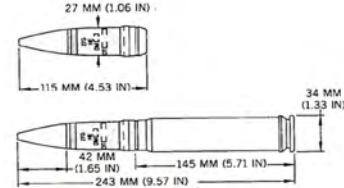

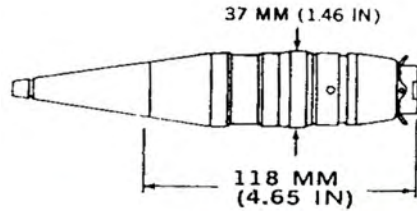

## U.S.S.R. CARTRIDGE, 37-MM, HEI-T, OZT

Ordnance used with:  
A-37U, PROJECTILE, PSDS  
OZT, 37 MM, HEIT

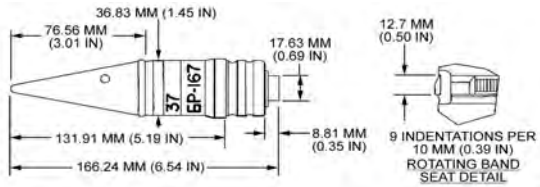

## U.S.S.R. PROJECTILE, 37-MM, AP-T, BR-167

Ordnance used with:  
UBR-167, 37-MM, CARTRIDGE, AP-T (253RMM)

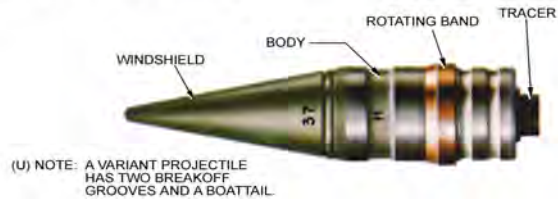

N.E.W. 12.25 G

## U.S.S.R. PROJECTILE, 37-MM, AP-T, TYPE BZT

Ordnance used with:  
BZT, 37MM, CARTRIDGE, AP-T



## U.S.S.R. PROJECTILE, 37-MM, FRAG-T, OR-167N

Ordnance used with:  
B-37, PROJECTILE, PDS  
MG-37, PROJECTILE, PDS  
MG-8, PROJECTILE, PDS  
UOR-167N, 37-MM X 253RMM, CARTRIDGE, FRAG-T  
UOR-167N, 37-MM, CARTRIDGE, FRAG-T

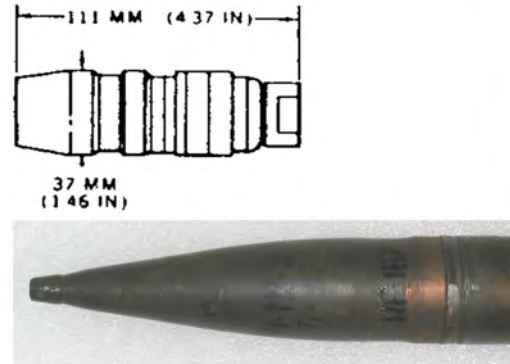

N.E.W. 35.00 G

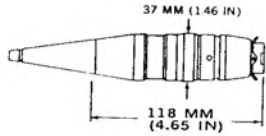

## U.S.S.R. PROJECTILE, 37-MM, HEI-T, OZT

Ordnance used with:  
A-37, PROJECTILE, PDS  
A-37U, PROJECTILE, PDS  
OZT, 37MM, CARTRIDGE, HEIT

N.E.W. 37.00 G

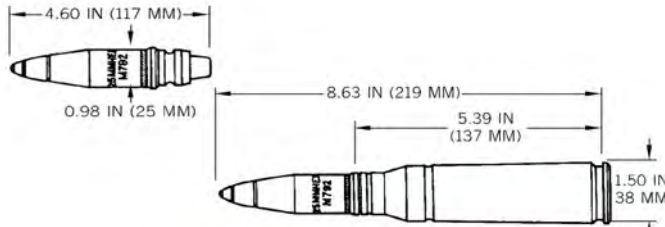

## U.S. CARTRIDGE, 25-MM, HEI-T, M792

Ordnance used with:  
M758, FUZE, PROJECTILE, PDSQ  
M758A1, FUZE, PROJECTILE, PDS  
M792, 25-MM, HEI-T

N.E.W. 92.00 G

**U.S.S.R. PROJECTILE, 100-MM, APFSDS-T, BM-2**

Ordnance used with:  
UBM-2, CARTRIDGE, 100-MM, APFSDS

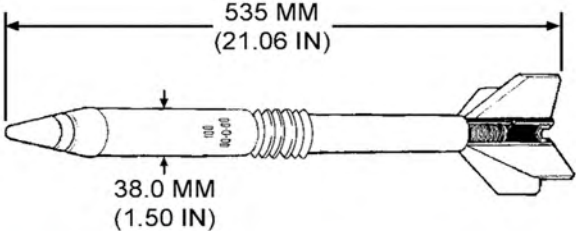

**U.S.S.R. PROJECTILE, 100-MM, APFSDS-T, BM-20**

Ordnance used with:  
UBM-8, CARTRIDGE, 100-MM, APFSDS

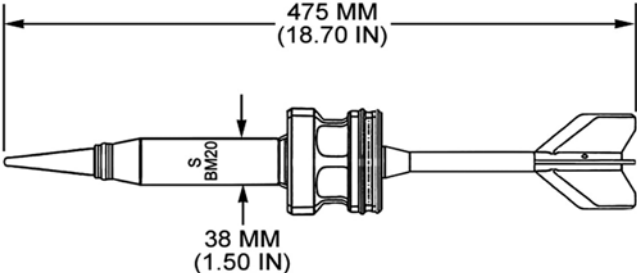

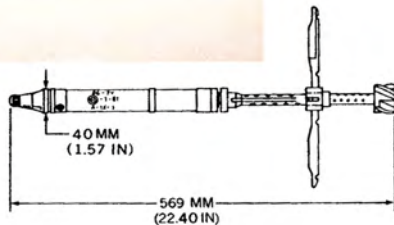

## BULGARIAN PROJECTILE, 40-MM, HE, OG-7V

Ordnance used with:

M-6

M6, PROJECTILE, PD

GO-2, PROJECTILE, PD

O-4M, PROJECTILE, PD

PG-7P, EJECTION CHARGE FOR PG-7-SERIES ROCKETS

OG-7V, 40MM, FRAG

N.E.W. 340.50 G



## CHINESE PROPELLING CHARGE, PG-2

Ordnance used with:

TYPE 56, 80MM, HEAT, (VARIANT 3)

TYPE 56, 80MM, HEAT, MODIFIED

PG-2, 80MM, HEAT

TYPE 56, 80MM, HEAT

RPG-2, LNCHR.

TYPE 56, LNCHR.

TYPE 56, 80MM, HEAT, (VARIANT 1)

N.E.W. 154.00 G



## RUSSIAN CARTRIDGE, 30-MM, AP-T, BT-30

Ordnance used with:  
BT-30, 30MM, AP-T

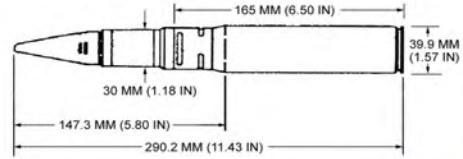

## U.S. CARTRIDGE, 40-MM, HEDP, M433

Ordnance used with:  
M550, PROJECTILE, PIBD  
M9, PROPELLING CHARGE  
M42, PERCUSSION PRIMER  
M118, CARTRIDGE CASE, 40 MM  
M433, 40 MM, HEDP

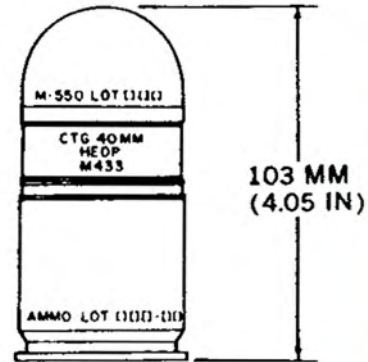

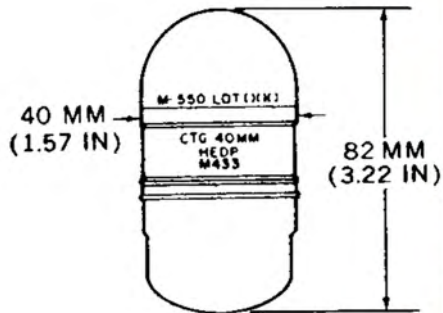

### U.S. PROJECTILE, 40-MM, HEDP, M433

Ordnance used with:  
M433, 40MM, CARTRIDGE, HEDP  
M550, PROJECTILE, PIBD

N.E.W. 43.00 G

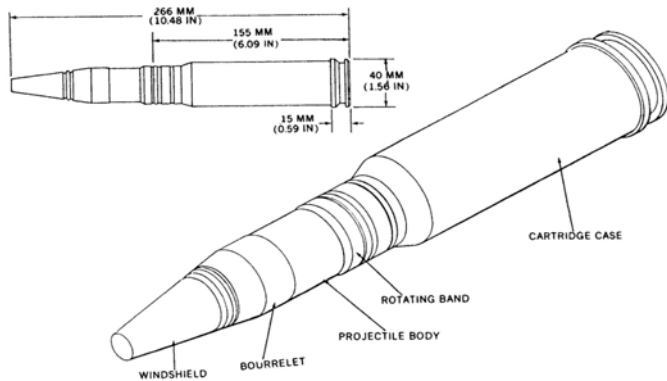

### U.S.S.R. CARTRIDGE, 30-MM, APHEI, OFT WITH BD-30 FUZE

Ordnance used with:  
OFT, 30MM, APHEI (EARLY)  
BD-30, PROJECTILE, BD

N.E.W. 134.00 G

## U.S.S.R. CARTRIDGE, 30-MM, APHEI, OFT WITH BDM-30 FUZE

Ordnance used with:  
BDM-30, PROJECTILE, BD  
OFT, 30MM, APHEI (EARLY)  
BR-30, TYPE II, 30-MM, APHEI  
OFT, 30MM, APHEI (CURRENT)  
BD-30, PROJECTILE, BD

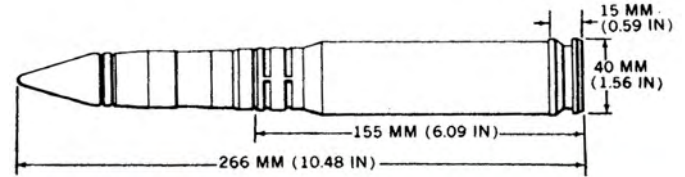

N.E.W. 134.00 G

## U.S.S.R. CARTRIDGE, 30-MM, FRAG-HEI, MODEL UNKNOWN

Ordnance used with:  
A-670M, PROJECTILE, PDSD  
A670M, PROJECTILE, PDSD  
MG-32, PROJECTILE, PDSD  
MG32, PROJECTILE, PDSD  
OF-84, 30MM, HEI  
OFZ, 30MM, HEI

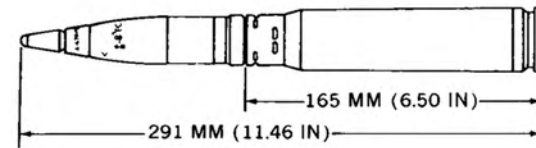

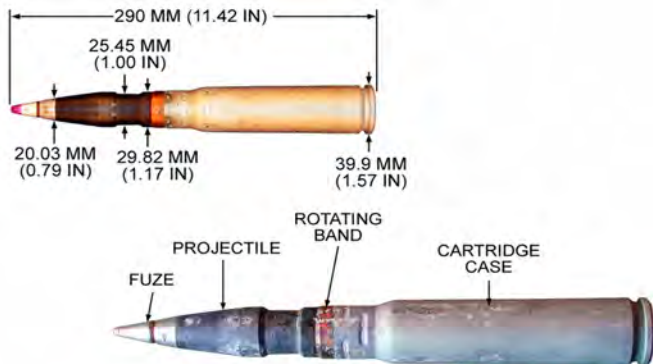

## U.S.S.R. CARTRIDGE, 30-MM, HE-T, OT

Ordnance used with:  
FT, 30-MM, HE-T  
OR-84, 30MM, HE-T  
OT, 30-MM, HE-T  
OT-30, 30-MM, HE-T  
A-670M, PROJECTILE, PDS  
A670M, PROJECTILE, PDS  
MG-32, PROJECTILE, PDS



## U.S.S.R. PROJECTILE, 40-MM, FRAG, BOUNDING, VOG-25

Ordnance used with:  
VMG-M, PROJECTILE, PDS

## RUSSIAN CARTRIDGE, 30-MM X 165B, APHE, BR-30

Ordnance used with:  
BR-30, 30-MM, APHE

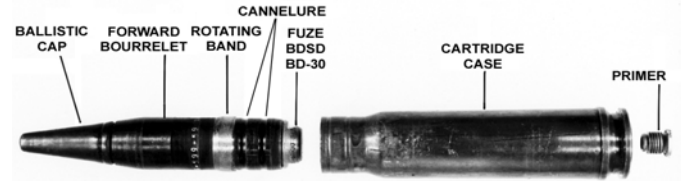

N.E.W. 358.00 G

## U.S.S.R. PROJECTILE, 40-MM, FRAG, BOUNDING, VOG-25P

Ordnance used with:  
BG-15  
GP-25  
GP-30  
GP-95  
GP-97



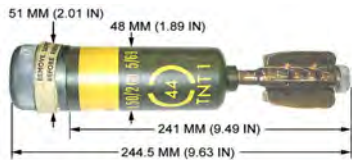

## U.K. PROJECTILE, 2-INCH, HE, MORTAR, MK 1

Ordnance used with:  
 NO. 161 MKS 3/2, PD, PROJECTILE  
 NO. 161 MK 4, PD, PROJECTILE  
 NO. 162 MK 1/1, PROJECTILE, PD



NOTE: BODY MAY BE PAINTED BROWN WITH A 7 MM RED STRIPE ADJACENT TO THE FUZE WELL AND A 12 MM GREEN STRIPE NEAR THE BASE OF THE PROJECTILE.



## U.S.S.R. CARTRIDGE, 37-MM, AP-T, UBR-167

Ordnance used with:  
 BR-167, 37-MM, AP-T  
 M1939, AIR DEFENSE GUN, 37MM, TOWED



## U.S.S.R. CARTRIDGE, 37-MM, FRAG-T, UOR-167N

Ordnance used with:  
B-37, PROJECTILE, PDSD  
MG-37, PROJECTILE, PDSD  
MG-8, PROJECTILE, PDSD  
OR-167N, 37-MM, FRAG-T  
M1939, AIR DEFENSE GUN, 37MM, TOWED

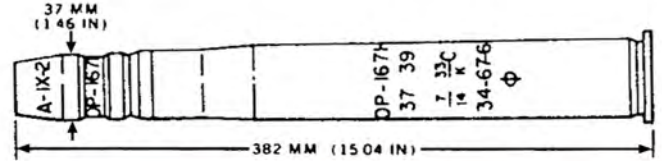

## U.S.S.R. PROJECTILE, 57 MM, APHE-T, BR-271M

Ordnance used with:  
MD-10, PROJECTILE, BD

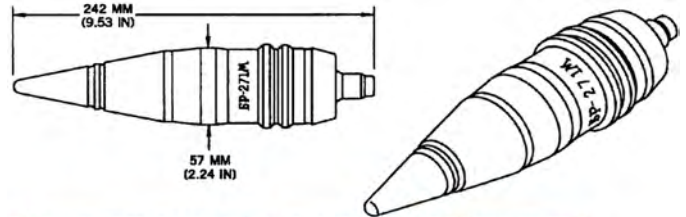

N.E.W. 13.00 G

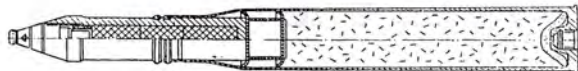
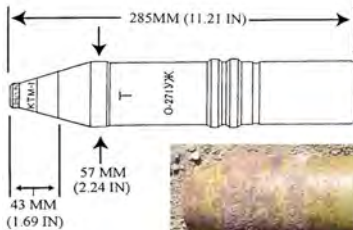

## U.S.S.R. PROJECTILE, 57 MM, FRAG, O-271UZH W/ CARTRIDGE, UO-271UZH

Ordnance used with:  
KTM-1U, PROJECTILE, PD  
KTM-1Y, PROJECTILE, PD  
O-271UZH, 57MM, HE  
UO-271UZH, 57MM, CARTRIDGE, HE

N.E.W. 200.00 G

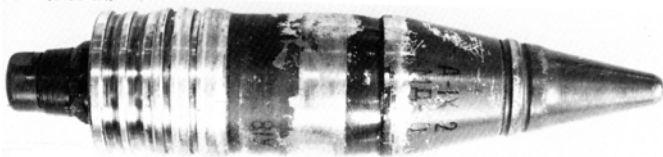
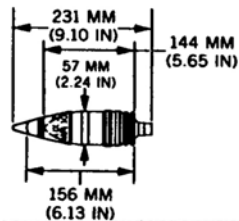

## U.S.S.R. PROJECTILE, 57-MM, APHE-T, BR-281

Ordnance used with:  
UBR-281, 57-MM, CARTRIDGE, APHE-T (57MM X 348MM)  
MD-10, PROJECTILE, BD

N.E.W. 18.00 G



## U.S.S.R. PROJECTILE, 57-MM, APHE-T, BR-281U

Ordnance used with:  
UBR-281U, 57-MM, CART, APHE-T (57MM X 348MM)  
MD-10, PROJECTILE, BD

N.E.W. 18.00 G



## U.S.S.R. PROJECTILE, 57-MM, FRAG-T, OR-281U

Ordnance used with:  
MG-57, PROJECTILE, PDS  
MGZ-57, PROJECTILE, PDS  
UOR-281U, CARTRIDGE, 57MM X 348MM, FRAG-T  
57-7N, PROJECTILE, PDS

N.E.W. 154.00 G

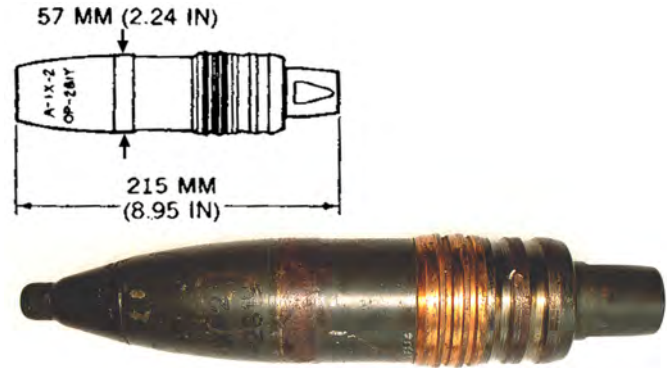

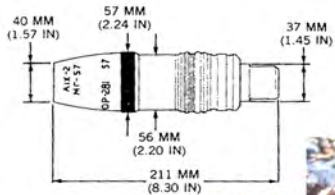

## U.S.S.R. PROJECTILE, 57-MM, HE, FRAG-T, OR-281

Ordnance used with:  
 MG-57, PROJECTILE, PDS  
 MGZ-57, PROJECTILE, PDS  
 UOR-281, CARTRIDGE, 57MM X 348MM, FRAG-T

## CANADIAN CARTRIDGE, 60-MM, SMOKE, WP, MORTAR, C157



Ordnance used with:  
 M935, PROJECTILE, PD  
 XM935, PROJECTILE, PD  
 C157, 60-MM, SMOKE, WP, MORTAR

## CHINESE CARTRIDGE, 60-MM, HE, MORTAR, M-83A

Ordnance used with:  
MP-1B, PROJECTILE, PD  
MP1B, PROJECTILE, PD  
83A  
M-83A, 60 MM, MORTAR, HE  
M38  
M83A  
TYPE 63

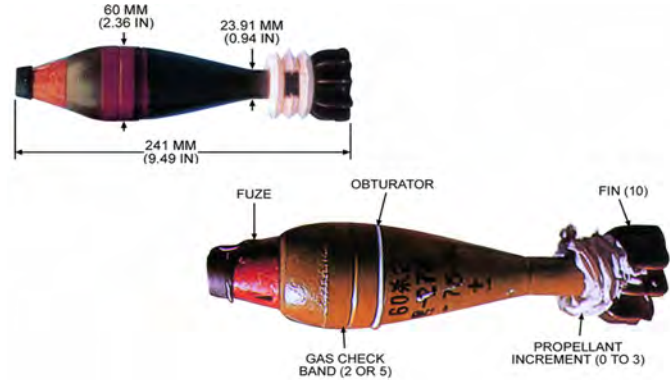

## CHINESE PROJECTILE, 60-MM, HE, MORTAR, M-83A

Ordnance used with:  
MP-1B, PROJECTILE, PD  
MP1B, PROJECTILE, PD  
M38, PROJECTILE, PD  
MP-1A, PROJECTILE, PD  
MP1A, PROJECTILE, PD  
UZRGM, GRENADE, STRIKER-RELEASE  
MP-1, PROJECTILE, PD  
N.E.W. 112.00 G

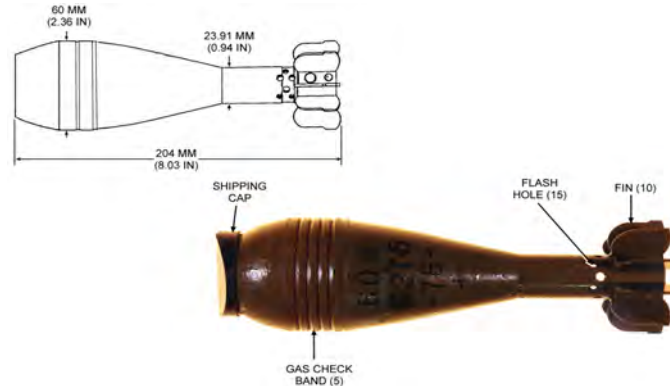

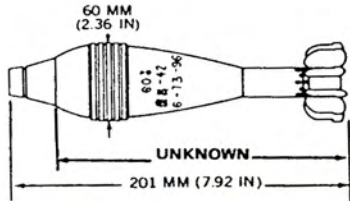

## CHINESE PROJECTILE, 60-MM, MORTAR, HE, MODEL UNKNOWN

Ordnance used with:  
 MP-1B, PROJECTILE, PD  
 MP1B, PROJECTILE, PD  
 M38, PROJECTILE, PD  
 MP-1A, PROJECTILE, PD  
 MP1A, PROJECTILE, PD  
 MP-1, PROJECTILE, PD  
 MP1, PROJECTILE, PD

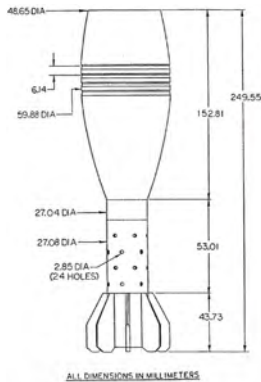

## IRANIAN PROJECTILE, 60-MM, MORTAR, HE, MODEL UNKNOWN

Ordnance used with:  
 M-6  
 M6, PROJECTILE, PD  
 MP-1B, PROJECTILE, PD  
 MP1B, PROJECTILE, PD  
 DM 111, PROJECTILE, PD  
 AZ DM111A1, PROJECTILE, PD  
 DM 111A1, PROJECTILE, PD  
 N.E.W. 196.00 G

## U.S. CARTRIDGE, 40-MM, HEI, PGU-9/B

Ordnance used with:  
MK 27 MOD 1, PROJECTILE, PD  
PGU-9/B, PROJECTILE, 40-MM, HEI

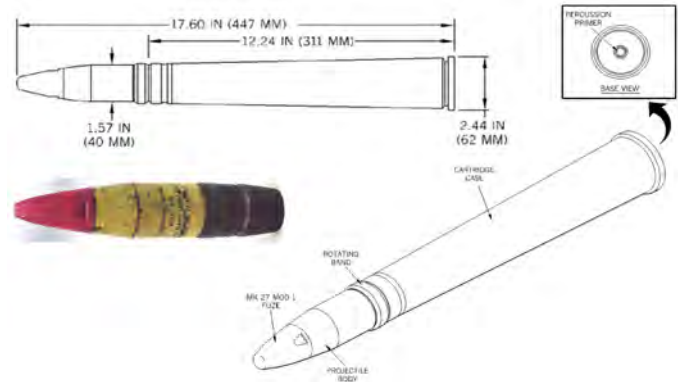

N.E.W. 380.00 G

## GERMAN PROJECTILES, 67-MM, HEAT AND APERS (ARMBRUST)

Ordnance used with:  
ARMBRUST, 67MM, CARTRIDGE, HEAT & APERS

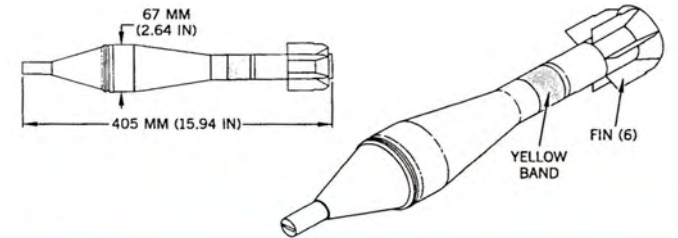

N.E.W. 169.00 G

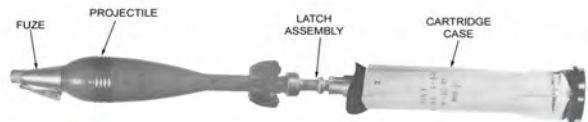

## ROMANIAN CARTRIDGE, 73-MM, HE, 346-E (TEARDROP, OG-9)

Ordnance used with:

- 346-E, 73MM, HE (TEARDROP)
- 346E, 73MM, HE (TEARDROP)
- OG-9, 73MM, HE (TEARDROP)
- OG-9/F, 73MM, HE (TEARDROP)
- 346-E, PROJECTILE, PD
- UB-2M, PROJECTILE, PD
- UB2, PROJECTILE, PD

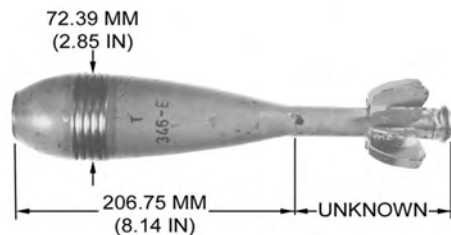

## ROMANIAN PROJECTILE, 73-MM, HE, 346-E

Ordnance used with:

- 346-E, PROJECTILE, PD
- UB-2M, PROJECTILE, PD
- UB2, PROJECTILE, PD
- UB2M, PROJECTILE, PD
- 346-E, 73MM, CARTRIDGE, HE (TEARDROP)
- 346E, 73MM, CARTRIDGE, HE (TEARDROP)
- OG-9, 73MM, CARTRIDGE, HE (TEARDROP)

N.E.W. 535.25 G

## BULGARIAN PROJECTILE, 73-MM, HE-FRAG, OG-9B

Ordnance used with:  
 GO-2, PROJECTILE , PD  
 O-4M, PROJECTILE, PD  
 OG-15VB, CARTRIDGE, 73 MM, HE  
 SPG-9, 73MM, RECOILESS RIFLE

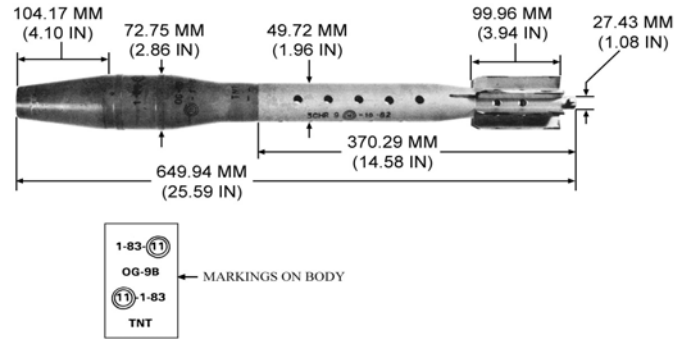

N.E.W. 371.95 G

## U.S.S.R. PROJECTILES, 73-MM, HE, FRAG, OG-9 & OG-9M

Ordnance used with:  
 GO-2, PROJECTILE , PD  
 UTIU M85, PROJECTILE, PD  
 O-4M, PROJECTILE, PD  
 OG-9P, 73MM, PROPELLING CHARGE  
 OG-15P, 73-MM, CARTRIDGE, HE  
 SPG-9, 73MM, RECOILESS RIFLE  
 OG-9V, 73MM, CARTRIDGE, FRAG

N.E.W. 704.82 G

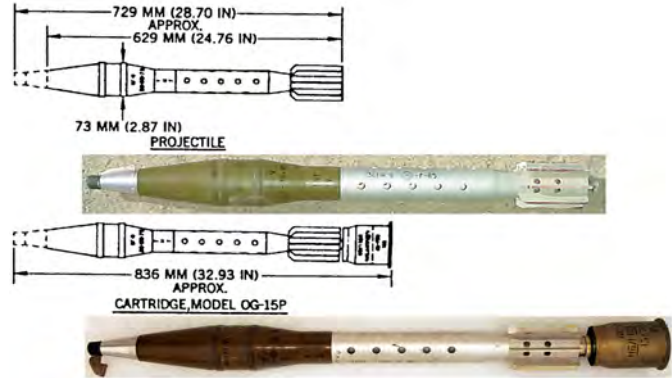



## CHINESE CARTRIDGE, 75-MM, HE, TYPE 52

Ordnance used with:  
 TYPE 1, PROJECTILE, PD (RR)  
 M30P-1  
 TYPE 6, PROJECTILE, PD  
 TYPE 52, 75 MM, HE, RR

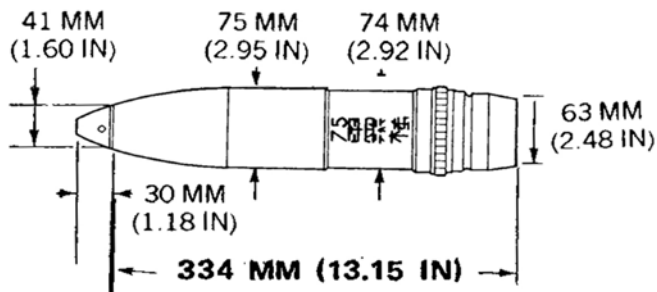

## CHINESE PROJECTILE, 75-MM, HEAT, TYPE UNKNOWN (COPY OF US M310A1)

Ordnance used with:  
 UNKNOWN, PROJECTILE, PIBD  
 TYPE 56, CARTRIDGE, 75MM, HEAT

N.E.W. 637.00 G



## CHINESE PROJECTILE, 75-MM, RR, HEAT, TYPE 52

Ordnance used with:  
TYPE 1 (SPECIAL), PROJECTILE, PIBD  
TS-1, PROJECTILE, PIBD  
TS-2, PROJECTILE, PIBD  
TYPE 1, PROJECTILE, PIBD  
TYPE 52, CARTRIDGE, 75MM, HEAT

N.E.W. 343.00 G

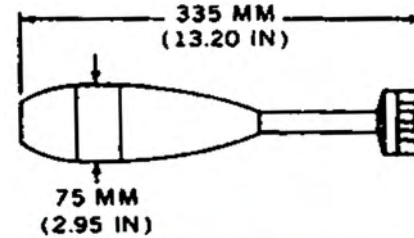

## GERMAN CARTRIDGES, 67-MM, HEAT AND APERS (ARMBRUST)

Ordnance used with:  
ARMBRUST, 67MM, HEAT  
ARMBRUST, 67MM, APERS  
ARMBRUST SC, 67MM, PRACTICE

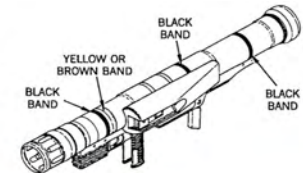
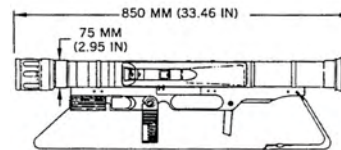

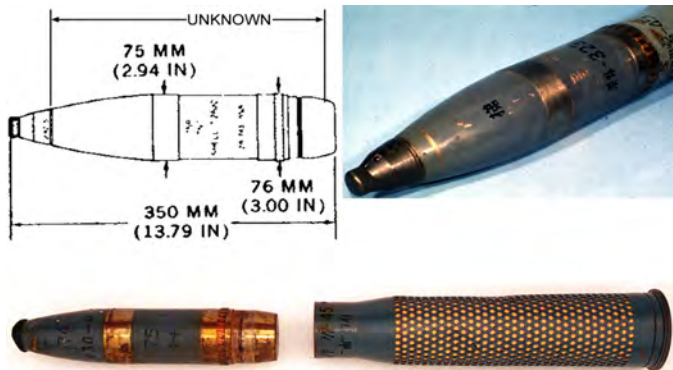

## CHINESE PROJECTILE, 75-MM, HE, TYPE 26.12

Ordnance used with:  
 TYPE 1, PROJECTILE, MORTAR, PD  
 TYPE 1 (ARTILLERY), PROJECTILE, PD  
 TYPE 1, PROJECTILE, PD (RR)  
 TYPE 3 (SPECIAL) (RECOILLESS RIFLE), PROJ, PD  
 TYPE 53, PROJECTILE, PD

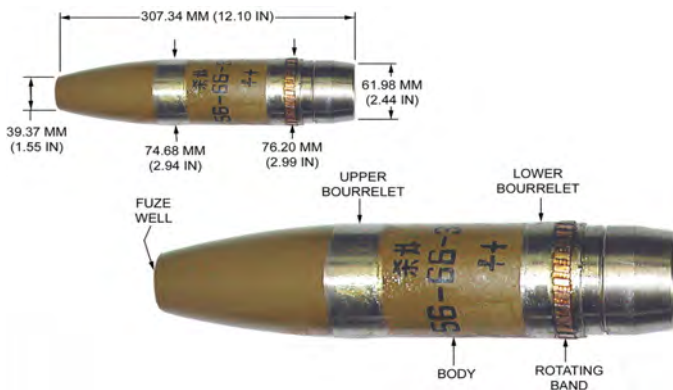

## CHINESE PROJECTILE, 75-MM, HE, TYPE 52

Ordnance used with:  
 TYPE 1, PROJECTILE, PD (RR)  
 M30P-1  
 TYPE 6, PROJECTILE, PD  
 TYPE 52, CARTRIDGE, 75MM, HE

N.E.W. 0.71 KG

## U.K. CARTRIDGE, 3-INCH, HE, MORTAR, MK 2

Ordnance used with:  
NO. 162 /1, PROJECTILE, PD  
MK 2, 3-INCH, HE, MOTAR



---

## U.K. CARTRIDGE, 3-INCH, HE, MORTAR, MK 6

Ordnance used with:  
NO. 162 MK 1/2, PROJECTILE, PD



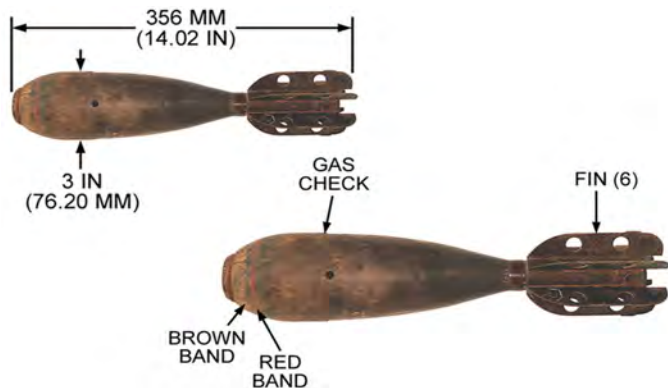

### U.K. PROJECTILE, 3-INCH, SMOKE (WP), MORTAR, MK 7

Ordnance used with:

- NO. 162 MK 1/2, PROJECTILE, PD
- NO. 162 MK 10, PROJECTILE, PD
- NO. 162 MK 3, PROJECTILE, PD
- NO. 162 MK 3/1, PROJECTILE, PD
- NO. 162 MK 3/2, PROJECTILE, PD
- NO. 162 MK 3/3, PROJECTILE, PD
- NO. 162 MK 4, PROJECTILE, PD

### U.K. PROJECTILE, 3-INCH, SMOKE (WP), MORTAR, MK II



Ordnance used with:

- NO. 162 MK 1/2, PROJECTILE, PD
- NO. 162 MK 10, PROJECTILE, PD
- NO. 162 MK 3, PROJECTILE, PD
- NO. 162 MK 3/1, PROJECTILE, PD
- NO. 162 MK 3/2, PROJECTILE, PD
- NO. 162 MK 3/3, PROJECTILE, PD
- NO. 162 MK 4, PROJECTILE, PD

## U.K. PROJECTILE, 3-INCH, SMOKE, MORTAR, MK 5

Ordnance used with:  
NO. 390 MK 5, TIME



---

## U.S.S.R. CARTRIDGE, 76-MM, FRAG-HE, UOF-353M

Ordnance used with:  
KTM-1, PROJECTILE, PD  
OF-350, 76-MM, HE-FRAG  
M1942 (ZIS-3), FIELD GUN, 76MM



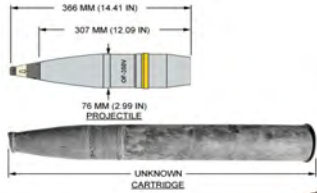

## U.S.S.R. CARTRIDGE, 76-MM, HE, UOF-15

Ordnance used with:  
RGM-2M, PROJECTILE, PD  
OF-350V, 76-MM, HE

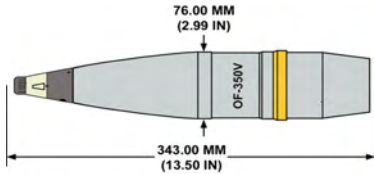

## U.S.S.R. PROJECTILE, 76-MM, FRAG-HE, OF-350V

Ordnance used with:  
RGM-2M, PROJECTILE, PD  
UOF-15, 76-MM, CARTRIDGE, HE



N.E.W. 604.00 G

## U.S.S.R. PROJECTILE, 76-MM, HE, FRAG, OF-350

Ordnance used with:

NSC-1, PROJECTILE, PDS  
KT-1, FUZE, PROJECTILE, PD  
KT-2, FUZE, PROJECTILE, PD  
KT-3, FUZE, PROJECTILE, PD  
KTM-1, PROJECTILE, PD  
KTM-1U, PROJECTILE, PD  
KTM-1Y, PROJECTILE, PD

N.E.W. 713.00 G

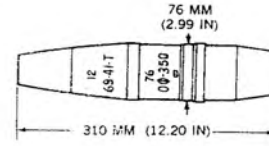

## U.S.S.R. PROJECTILE, 76-MM, HE, FRAG, OF-350A

Ordnance used with:

3GT, FUZE, PROJECTILE, PD  
KT-1, FUZE, PROJECTILE, PD  
KT-2, FUZE, PROJECTILE, PD  
KT-3, FUZE, PROJECTILE, PD  
KTM-1, PROJECTILE, PD  
KTM-2, PROJECTILE, PD  
KTM-3, PROJECTILE, PD

N.E.W. 1.60 LB

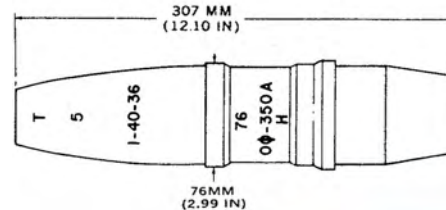

## U.S.S.R. PROJECTILE, 76-MM, HEAT-FS, BK-354M

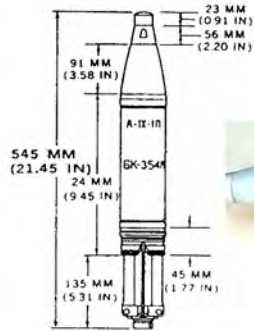

Ordnance used with:  
GPV-2, PROJECTILE, PIBD, SPITBACK

N.E.W. 0.80 KG

## U.S.S.R. PROJECTILE, 76-MM, SMOKE, D-350

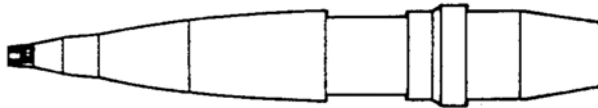
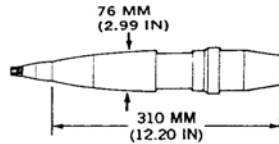

Ordnance used with:  
KT-1, FUZE, PROJECTILE, PD  
KT-2, FUZE, PROJECTILE, PD  
KT-3, FUZE, PROJECTILE, PD  
KTM-1, PROJECTILE, PD  
KTM-1U, PROJECTILE, PD  
KTM-1Y, PROJECTILE, PD  
KTM-2, PROJECTILE, PD



## CHINESE PROJECTILE, 80-MM, HEAT, TYPE 56 (VARIANT 1)

Ordnance used with:  
DK-2, PROJECTILE, BD  
TYPE 4, PROJECTILE, BD  
RPG-2, LNCHR.  
TYPE 56, LNCHR.  
PG-2, PROPELLING CHARGE



---

## CHINESE PROJECTILE, 80-MM, HEAT, TYPE 56 (VARIANT 2)

Ordnance used with:  
DK-2, PROJECTILE, BD  
TYPE 4, PROJECTILE, BD  
RPG-2, LNCHR.  
TYPE 56, LNCHR.  
PG-2, PROPELLING CHARGE



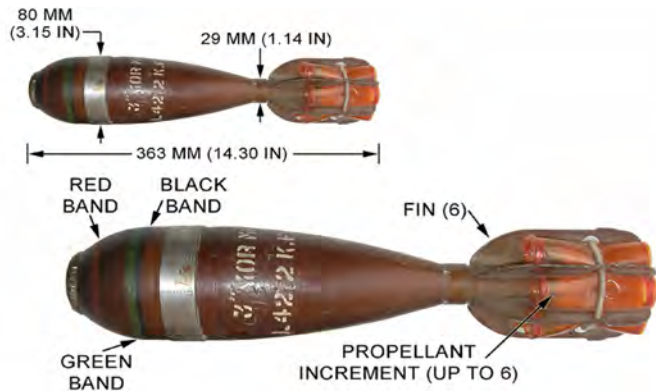

### U.K. PROJECTILE, 3-INCH, HE, MK 3

Ordnance used with:  
 NO. 152 I, PROJECTILE, PD  
 NO. 162 MK 2/1, PROJECTILE, PD

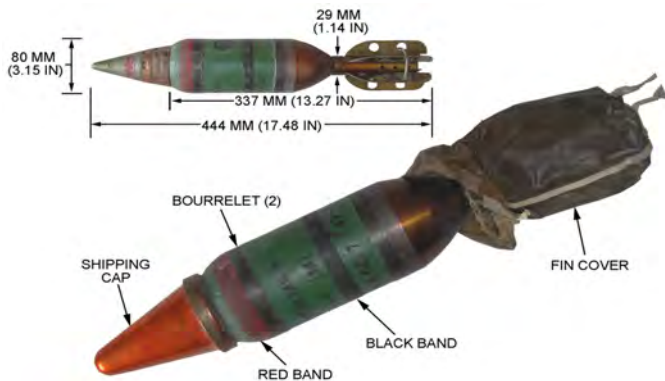

### U.K. PROJECTILE, 3-INCH, SMOKE (WP), MORTAR, MK 4

Ordnance used with:  
 NO. 390 MK 2A, PROJECTILE, PTT

## AUSTRIAN CARTRIDGE, 81-MM, MORTAR, LONG DISTANCE, HE, HE 70LD

Ordnance used with:  
M525A1, PROJECTILE, PD  
M935, PROJECTILE, PD  
XM935, PROJECTILE, PD  
AZ 111 A2  
AZ DM 111A2, PD  
DM 111A2, PROJECTILE, PD  
DM 111A3, PROJECTILE, PD  
N.E.W. 748.00 G

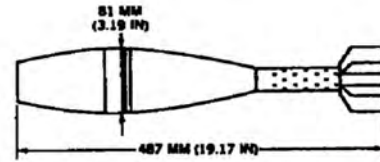

## CANADIAN PROJECTILE, 81-MM, ILLUMINATION, MORTAR, C105

Ordnance used with:  
DM 93-2, PROJECTILE, MT  
C105, CARTRIDGE, 81 MM, ILLUM, MORTAR



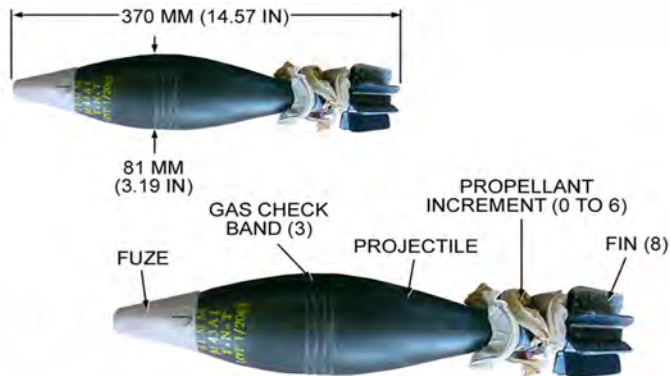

## IRANIAN CARTRIDGE, 81-MM, HE, MORTAR, M43A1

Ordnance used with:  
 AZ 111 A2  
 AZ DM 111A2, PD  
 DM 111A2, PROJECTILE, PD  
 AZ111 A2, PROJECTILE, PD  
 AZ111-A2  
 PAI-1A, PROJECTILE, PD  
 M43A1, 81MM, HE

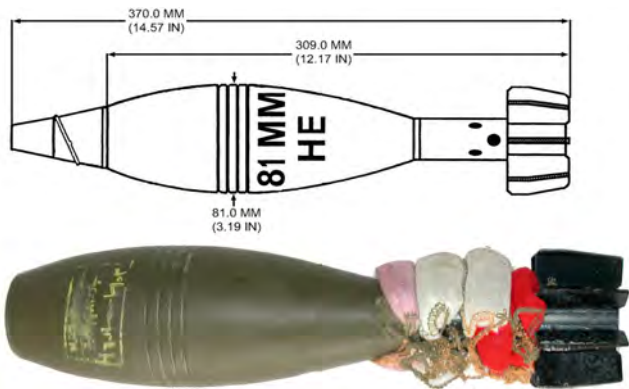

## IRANIAN CARTRIDGE, 81-MM, HE, MORTAR, MODEL UNKNOWN

Ordnance used with:  
 MP-5C  
 MP5C, PROJECTILE, PD  
 AZ111 A2, PROJECTILE, PD  
 AZ111-A2  
 MP-7A  
 MP7A, PROJECTILE, PD  
 MP-5B, PROJECTILE, PD  
 N.E.W. 550.00 G

## IRANIAN CARTRIDGE, HE, MORTAR, MODEL UNKNOWN

Ordnance used with:  
MP-7A  
MP7A, PROJECTILE, PD  
UNKNOWN, 81MM, HE, MORTAR

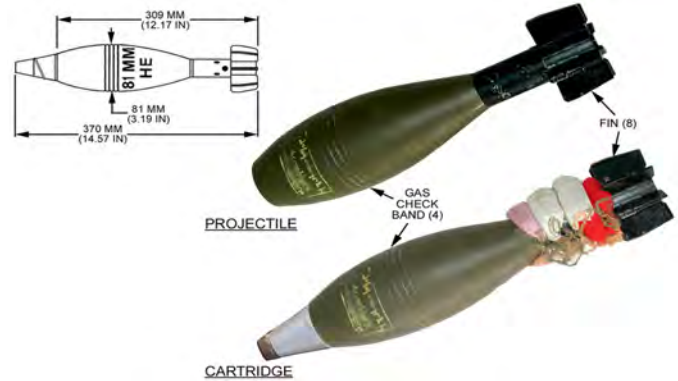

## IRANIAN PROJECTILE, 81-MM, HE, MORTAR, M43A1

Ordnance used with:  
AZ 111 A2  
AZ DM 111A2, PD  
DM 111A2, PROJECTILE, PD  
AZ111 A2, PROJECTILE, PD  
AZ111-A2  
M38, PROJECTILE, PD  
MP-1A, PROJECTILE, PD



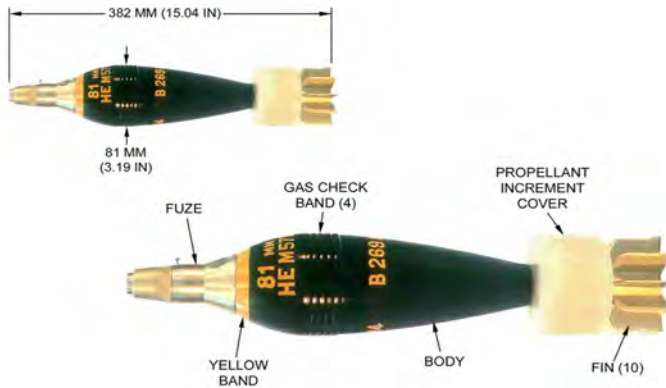

## PAKISTANI CARTRIDGE, 81-MM, HE, MORTAR, M57 DA-2

Ordnance used with:  
 V19PA-A2, PROJECTILE, PD  
 M57 DA-2, 81MM, MORTAR, HE  
 V19PA, PROJECTILE, PD

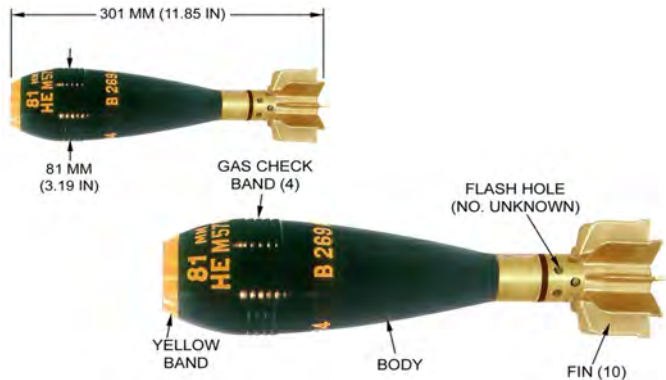

## PAKISTANI PROJECTILE, 81-MM, HE, MORTAR, M57 DA-2

Ordnance used with:  
 PAI-1A, PROJECTILE, PD  
 PAI1A  
 V19PA-A2, PROJECTILE, PD  
 M57 DA-2, 81-MM, CARTRIDGE, MORTAR, HE  
 V19PA, PROJECTILE, PD

## U.S. CARTRIDGE, 81-MM, MORTAR, HE, M821

Ordnance used with:  
M567, PROJECTILE, PD  
XM567E5, PROJECTILE, PD  
M734 PROJECTILE, MULTIOPTION  
M935, PROJECTILE, PD  
XM935, PROJECTILE, PD

N.E.W. 726.00 G

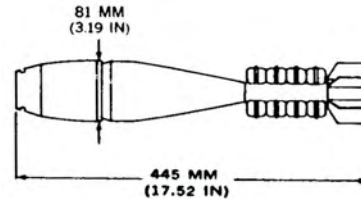

## U.S. PROJECTILE, 81-MM, ILLUMINATION, M853A1

Ordnance used with:  
M768 PROJECTILE, PTT  
M772 PROJECTILE, MTSQ  
M853A1, 81MM, ILLUM

N.E.W. 1.80 LB

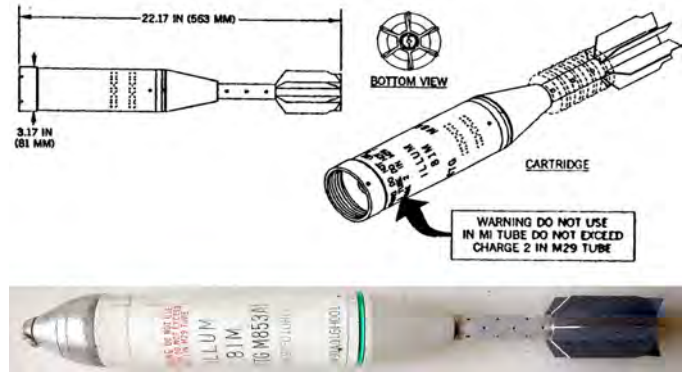

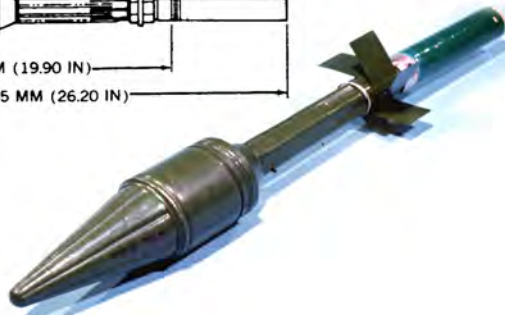
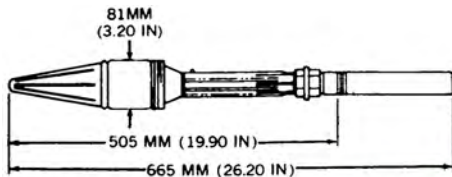

## U.S.S.R. CARTRIDGE, 80-MM, HEAT, PG-2; CHINESE CARTRIDGE, HEAT, TYPE 56

Ordnance used with:  
 DK-4, PROJECTILE, BD  
 DK-2, PROJECTILE, BD  
 TYPE 4, PROJECTILE, BD  
 RPG-2, LNCHR.  
 TYPE 56, LNCHR.  
 PG-2, PROPELLING CHARGE

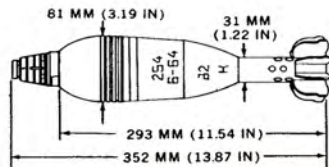

## U.S.S.R. PROJECTILE, 82-MM, ILLUM, S-832S

Ordnance used with:  
 T-1, PROJECTILE, TSQ



## AUSTRIAN CARTRIDGE, 82-MM, HE, MORTAR, HE83 LD

Ordnance used with:  
PDM525, PROJECTILE, PD  
T37A1B1, PROJECTILE, PD  
HE 83 LD  
HE 83, 82-MM, MORTAR, HE  
HE83 LD, 82MM, HE  
M52B1, PROJECTILE, PD  
TP 70, IGNITER, MORTAR

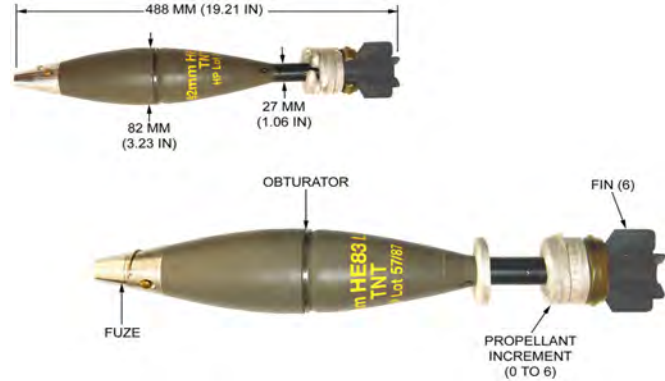

## AUSTRIAN PROJECTILE, 82-MM, HE, MORTAR, HE83 LD

Ordnance used with:  
PDM525, PROJECTILE, PD  
T37A1B1, PROJECTILE, PD  
M52B1, PROJECTILE, PD  
HE 83 LD, CARTRIDGE, 82MM, HE

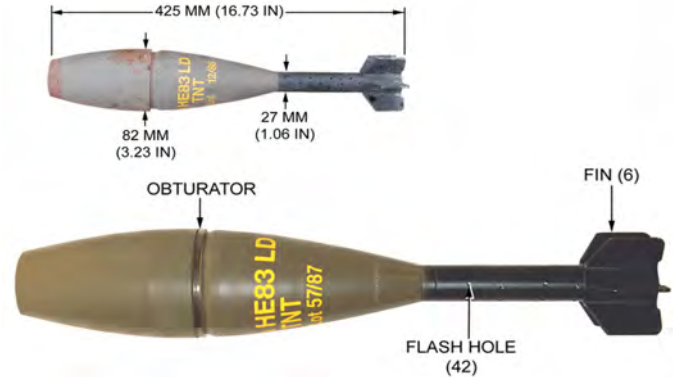

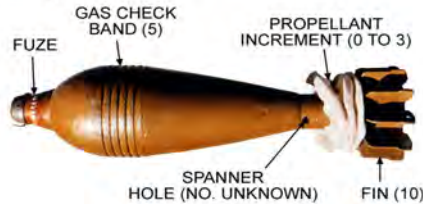

## CHINESE CARTRIDGE, 82-MM, HE, MORTAR, TYPE 53

Ordnance used with:  
 MP-1B, PROJECTILE, PD  
 MP1B, PROJECTILE, PD  
 M38, PROJECTILE, PD  
 MP-1A, PROJECTILE, PD  
 MP1A, PROJECTILE, PD  
 TH521, 82-MM, HE  
 TYPE 53, 82-MM, HE

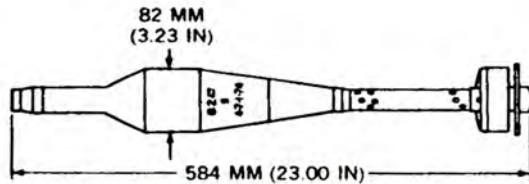

## CHINESE CARTRIDGE, 82-MM, HEAT, DK 82 (TYPE 65)

Ordnance used with:  
 TYPE 4, PROJECTILE, BD  
 DK 82, 82MM, HEAT  
 TYPE 65

N.E.W. 595.00 G

## CHINESE CARTRIDGE, 82MM, HEAT, TYPE 65 (VARIANT 2)

Ordnance used with:  
TYPE 65 (VARIANT 2), 82MM, HEAT

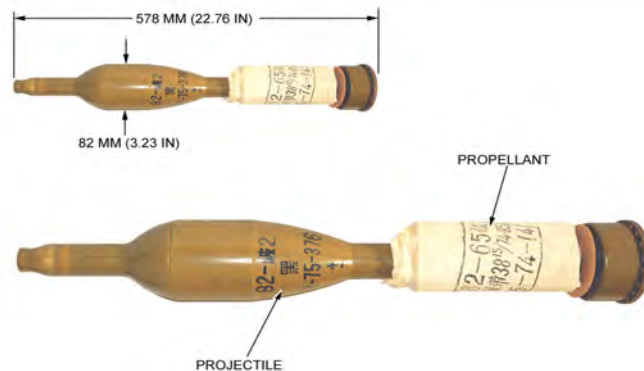

## CHINESE PROJECTILE, 82-MM, HE, MORTAR, 42-832

Ordnance used with:  
MM-6, PROJECTILE, PD



## CHINESE PROJECTILE, 82-MM, HE, MORTAR, M30

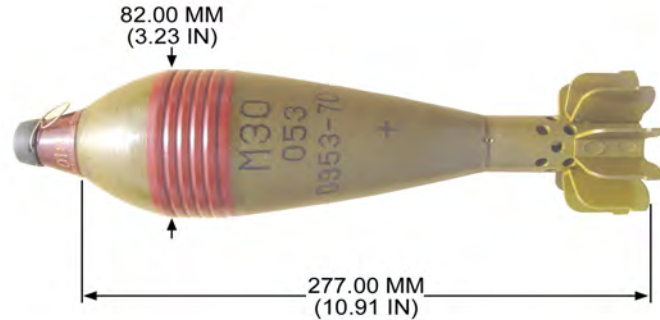

Ordnance used with:  
M-6, PROJECTILE, PD  
M30P-1  
TYPE 6, PROJECTILE, PD

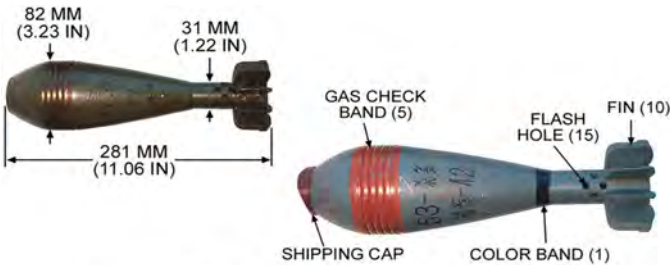

## CHINESE PROJECTILE, 82-MM, HE, MORTAR, TYPE 53

Ordnance used with:  
MP-1B, PROJECTILE, PD  
MP1B, PROJECTILE, PD  
M38, PROJECTILE, PD  
MP-1A, PROJECTILE, PD  
MP1A, PROJECTILE, PD  
TYPE UNIVERSAL MODIFIED, PD  
MP-1, PROJECTILE, PD  
N.E.W. 0.86 LB

### ALTERNATE COLOR SCHEMES



## CHINESE PROJECTILE, 82-MM, HE-FRAG, (TYPE 64)

Ordnance used with:  
TYPE 2, PROJECTILE, PD  
TYPE 64, 82-MM, HE, FRAG, MORTAR, CARTRIDGE

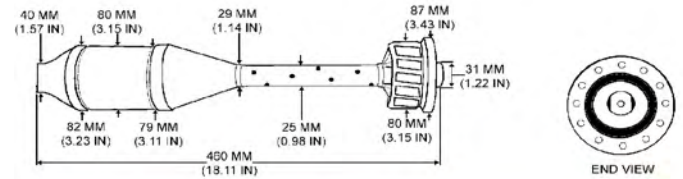

## CHINESE PROJECTILE, 82-MM, HEAT, DK-82 (TYPE 65)

Ordnance used with:  
DK 82, CARTRIDGE, 82MM, HEAT  
TYPE 65  
TYPE 4, PROJECTILE, BD

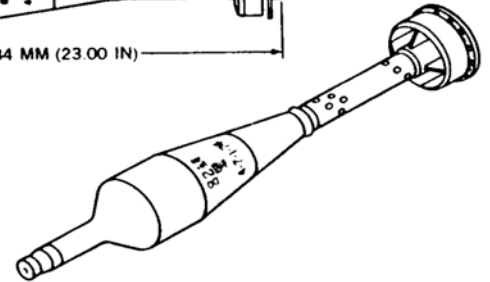
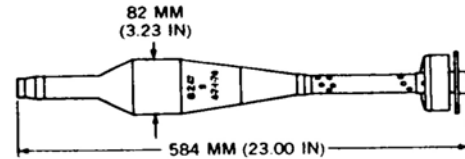

N.E.W. 428.00 G

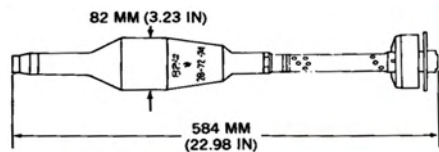

## CHINESE PROJECTILE, 82-MM, HEAT, DK-82 (TYPE 65/1) VARIANT

Ordnance used with:  
TYPE 4, PROJECTILE, BD

N.E.W. 595.00 G

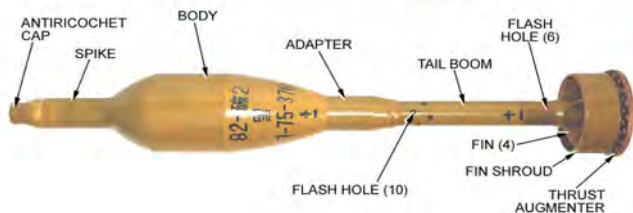

## CHINESE PROJECTILE, 82-MM, HEAT, TYPE 65 (VARIANT 2)

Ordnance used with:  
TYPE 4, PROJECTILE, BD  
TYPE 65 (VARIANT 2), CARTRIDGE, 82MM, HEAT

## CHINESE PROJECTILE, 82-MM, MORTAR, HE, MODEL UNKNOWN

Ordnance used with:  
MP-1B, PROJECTILE, PD  
MP1B, PROJECTILE, PD  
M38, PROJECTILE, PD  
MP-1A, PROJECTILE, PD  
MP1A, PROJECTILE, PD  
MP-1, PROJECTILE, PD  
MP1, PROJECTILE, PD

N.E.W. 399.00 G

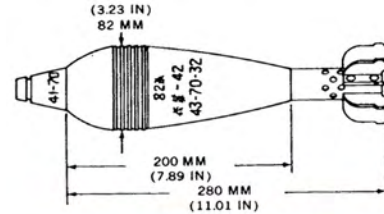

## CHINESE PROJECTILE, 82-MM, MORTAR, HE, MODEL UNKNOWN

Ordnance used with:  
M-6  
M6, PROJECTILE, PD  
PUI-1A, PROJECTILE, PD

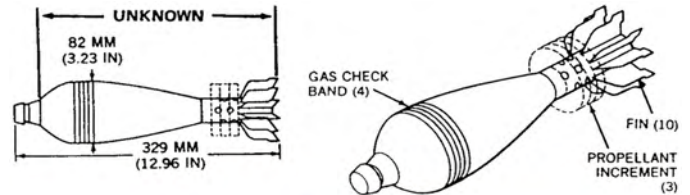



## NORTH KOREAN CARTRIDGE, 82-MM, FRAG, O-881

Ordnance used with:  
GK-1, FUZE, PROJECTILE, PD  
O-881, 82 MM, FRAG  
B-2, PROJECTILE, PD

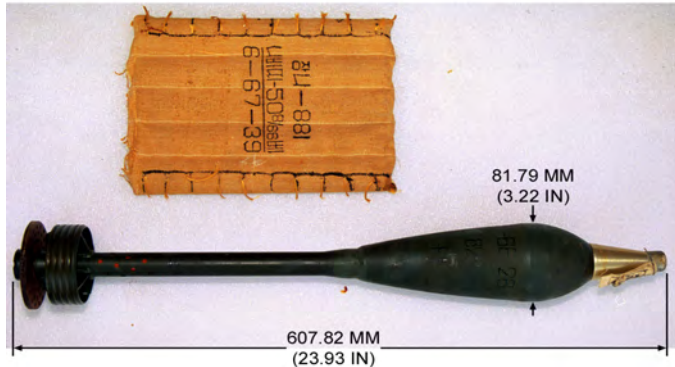

## NORTH KOREAN PROJECTILE, 82-MM, FRAG, O-881

Ordnance used with:  
GK-2, FUZE, PROJECTILE, PD  
O-881, CARTRIDGE, 82MM, FRAGMENTATION  
B-2, PROJECTILE, PD

N.E.W. 470.00 G



## PAKISTANI CARTRIDGE, 82-MM, HE, M-57D MK 1

Ordnance used with:  
PAI-1A, PROJECTILE, PD  
PAI1A  
V19PA-A2, PROJECTILE, PD  
PAI-1A, PROJECTILE, PD  
M-57D MK 1, 82MM, MORTAR, HE



## PAKISTANI PROJECTILE, 82-MM, HE, M-57D MK 1

Ordnance used with:  
PAI-1A, PROJECTILE, PD  
PAI1A  
V19PA-A2, PROJECTILE, PD  
PAI-1A, PROJECTILE, PD  
M-57D MK 1, CARTRIDGE, 82MM, MORTAR, HE



N.E.W. 681.00 G



**PAKISTANI PROJECTILE, 82-MM, HE, MORTAR,  
MODEL UNKNOWN**

Ordnance used with:  
PAI-1A, PROJECTILE, PD  
PAI1A

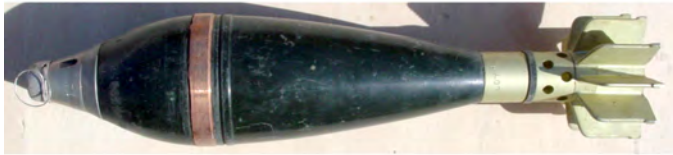

**SPANISH CARTRIDGE, 82-MM, SMOKE (WP),  
MORTAR, MODEL UNKNOWN**

Ordnance used with:  
EE-53-W-330  
EE53-W330, PROJECTILE, PD  
MDL. UNKNOWN, 82-MM, SMOKE, WP, MORTAR



## SPANISH PROJECTILE, 82-MM, MORTAR, WP, SMOKE, MODEL UNKNOWN

Ordnance used with:  
EE-53-W-330  
EE53-W330, PROJECTILE, PD  
MDL. UNKNOWN, 82-MM, SMOKE, WP, CARTRIDGE, MORTAR

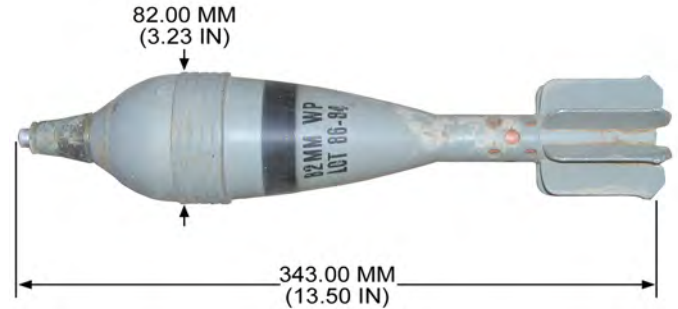

## U.S.S.R. CARTRIDGE, 82-MM, FRAG, MORTAR, UO-832 DU

Ordnance used with:  
SH-82, PROJECTILE, PD  
O-832DU, 82-MM, FRAG  
M-1, PROJECTILE, PDSQ  
TYPE 1, PROJECTILE, PD  
M-2, PROJECTILE, PD  
M-3, PROJECTILE, PD  
M-4, PROJECTILE, PD

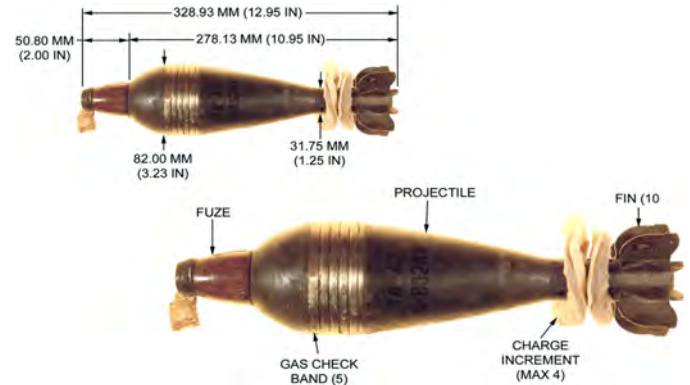

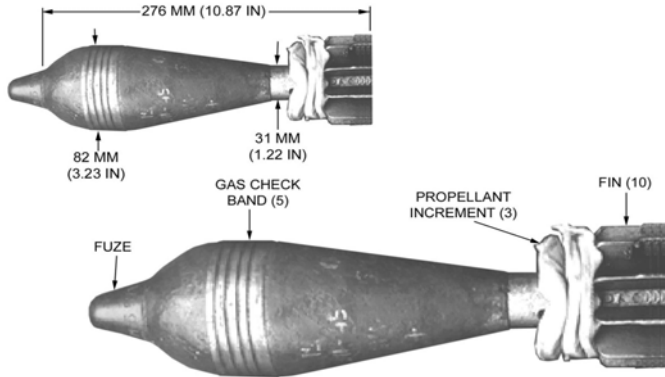

### U.S.S.R. CARTRIDGE, 82-MM, FRAG, MORTAR, UO-832D

Ordnance used with:  
 SH-82, PROJECTILE, PD  
 O-832D, 82-MM, MORTAR, FRAG  
 M-1, PROJECTILE, PDSQ  
 TYPE 1, PROJECTILE, PD  
 M-2, PROJECTILE, PD  
 M-3, PROJECTILE, PD  
 M-4, PROJECTILE, PD

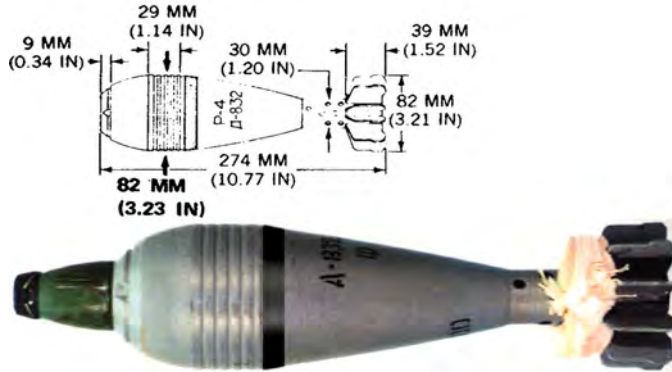

### U.S.S.R. CARTRIDGE, 82-MM, MORTAR, SMOKE, WP, D-832

Ordnance used with:  
 SH-82, PROJECTILE, PD  
 M-1, PROJECTILE, PDSQ  
 TYPE 1, PROJECTILE, PD  
 M-2, PROJECTILE, PD  
 M-3, PROJECTILE, PD  
 M-4, PROJECTILE, PD  
 M-5, PROJECTILE, PD

## U.S.S.R. CARTRIDGE, 82-MM, RECOILLESS, BK-881

Ordnance used with:  
GK-1, FUZE, PROJECTILE, PD  
GK-2, FUZE, PROJECTILE, PD  
GK-2M, FUZE, PROJECTILE, PD  
ZHN-881, 82MM, PROPELLING CHARGE

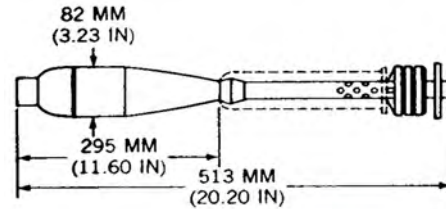

N.E.W. 1.36 KG

## U.S.S.R. PROJECTILE, 82-MM, MORTAR, FRAG, O-832-DU

Ordnance used with:  
SH-82, PROJECTILE, PD  
M-1, PROJECTILE, PDSQ  
TYPE 1, PROJECTILE, PD  
M-2, PROJECTILE, PD  
M-3, PROJECTILE, PD  
M-4, PROJECTILE, PD  
M-5, PROJECTILE, PD

N.E.W. 0.44 KG

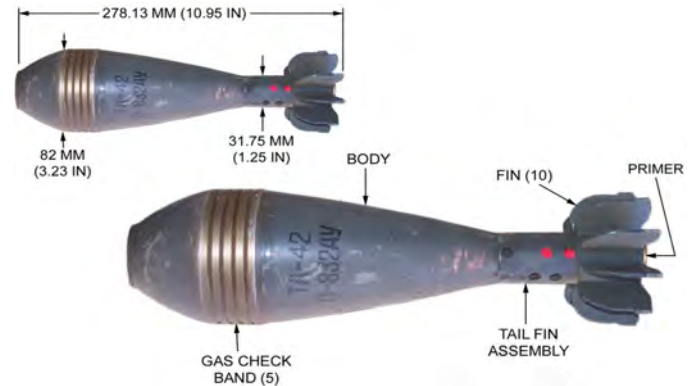

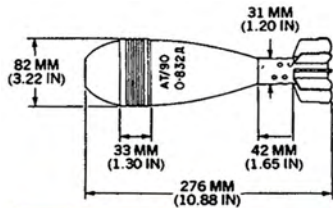

## U.S.S.R. PROJECTILE, 82-MM, MORTAR, FRAG, O-832D

Ordnance used with:  
 SH-82, PROJECTILE, PD  
 M-1, PROJECTILE, PDSQ  
 TYPE 1, PROJECTILE, PD  
 M-2, PROJECTILE, PD  
 M-3, PROJECTILE, PD  
 M-4, PROJECTILE, PD  
 M-5, PROJECTILE, PD

N.E.W. 0.41 KG

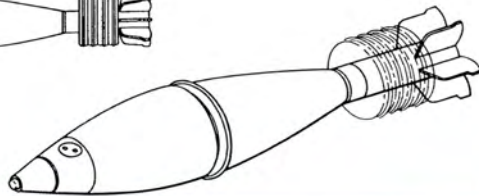
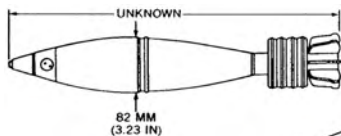

## YUGOSLAV CARTRIDGE, 82-MM, HE, MORTAR, M71

Ordnance used with:  
 UT M68 P1, PROJECTILE, PD  
 UT M68P1, PROJECTILE, PD  
 UT.M68 P1, PROJECTILE, PD  
 UTU M67, PROJECTILE, PD  
 M71, 82-MM, HE, MORTAR  
 UT M5P1, PROJECTILE, PD  
 UTM5P1, PROJECTILE, PD



## YUGOSLAV CARTRIDGE, 82-MM, HE, MORTAR, M74

Ordnance used with:  
UT M68 P1, PROJECTILE, PD  
UT M68P1, PROJECTILE, PD  
UT.M68 P1, PROJECTILE, PD  
M74, 82MM, HE, MORTAR  
M6-R, PROJECTILE, PD  
M-6R, PROJECTILE, PD

N.E.W. 680.00 G

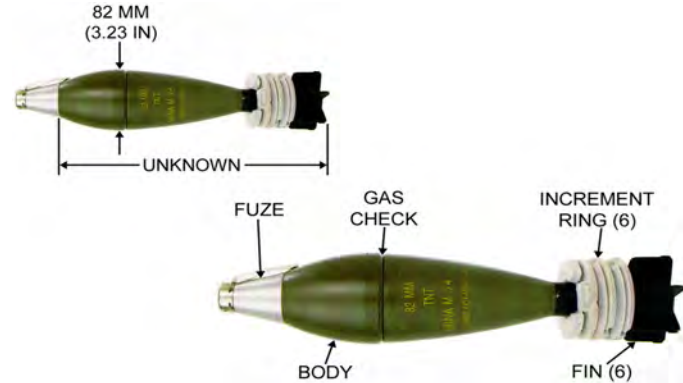

## YUGOSLAV CARTRIDGE, 82-MM, HE, MORTAR, M96

Ordnance used with:  
PDB 332, PROJECTILE, PD  
UTU M67, PROJECTILE, PD  
ER, 82MM, HE, MORTAR  
M96, 82-MM, HE, MORTAR  
UT M96, PROJECTILE, PD

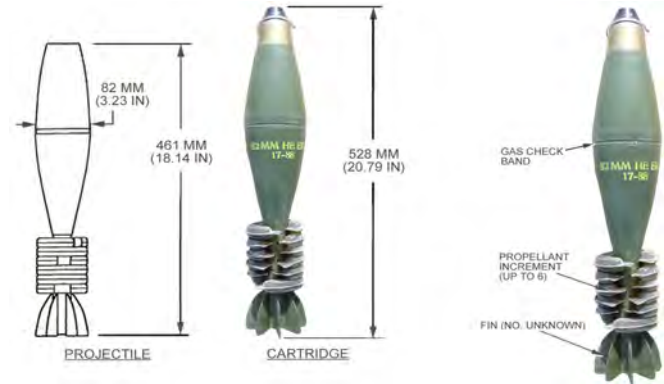

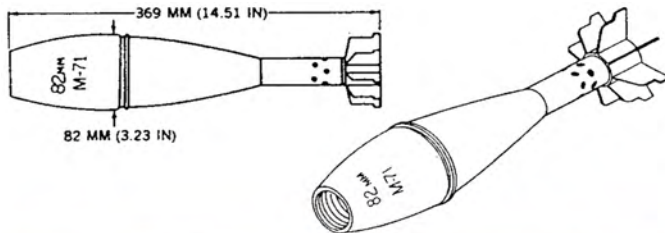

## YUGOSLAV PROJECTILE, 82-MM, HE, MORTAR, M71

Ordnance used with:

- UT M68 P1, PROJECTILE, PD
- UT M68P1, PROJECTILE, PD
- UT.M68 P1, PROJECTILE, PD
- UTU M67, PROJECTILE, PD
- UT M5P1, PROJECTILE, PD
- UTM5P1, PROJECTILE, PD
- M71, 82MM, CARTRIDGE, HE, MORTAR

N.E.W. 690.00 G

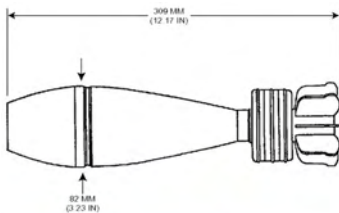

## YUGOSLAV PROJECTILE, 82-MM, HE, MORTAR, M74

Ordnance used with:

- UT M68 P1, PROJECTILE, PD
- UT M68P1, PROJECTILE, PD
- UT.M68 P1, PROJECTILE, PD
- UTU M67, PROJECTILE, PD
- M6-R, PROJECTILE, PD
- M-6R, PROJECTILE, PD
- M74, 82MM, CARTRIDGE, HE, MORTAR

N.E.W. 680.00 G





## YUGOSLAV PROJECTILE, 82-MM, HE, MORTAR, M96 (ER)

Ordnance used with:  
PDB 332, PROJECTILE, PD  
UTU M67, PROJECTILE, PD  
UT M96, PROJECTILE, PD  
ER, 82MM, CARTRIDGE, HE, MORTAR  
M96, 82MM, CARTRIDGE, HE, MORTAR

N.E.W. 860.00 G

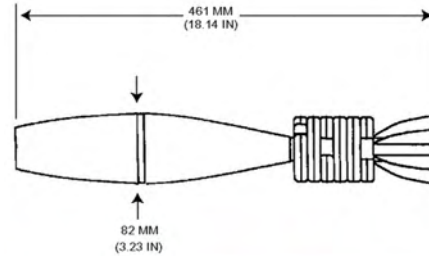

## YUGOSLAV PROJECTILE, 82-MM, MORTAR, SMOKE, M71

Ordnance used with:  
UT M70P1, PROJECTILE, PD  
UT,M70 P1, PROJECTILE, PD  
UTU M67, PROJECTILE, PD  
M71, 82-MM, CARTRIDGE, SMOKE, WP, MORTAR

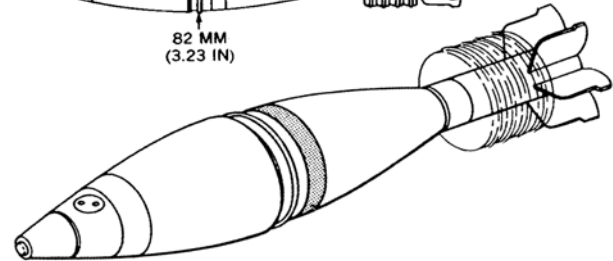
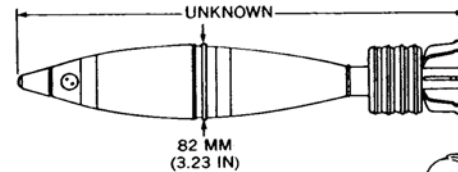

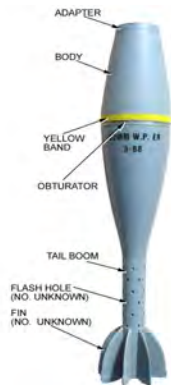

## YUGOSLAV PROJECTILE, 82-MM, SMOKE (WP), MORTAR, ER

Ordnance used with:  
PDB 332, PROJECTILE, PD

---

## U.S.S.R. CARTRIDGE, 73-MM, HE, OG-15P



Ordnance used with:  
GO-2, PROJECTILE , PD  
OG-9, 73-MM, HE-FRAG  
OG-9M, 73-MM, HE-FRAG  
SPG-9, 73MM, RECOILESS RIFLE

## SWEDISH CARTRIDGE, 84-MM, HE-FRAG, FFV 441B

Ordnance used with:  
FFV 447, PROJECTILE, MT  
FFV 441B, 84-MM, HE-FRAG  
M2 & M3, 84-MM SYSTEM, CARL-GUSTAF, RECOILLES...

N.E.W. 738.05 G

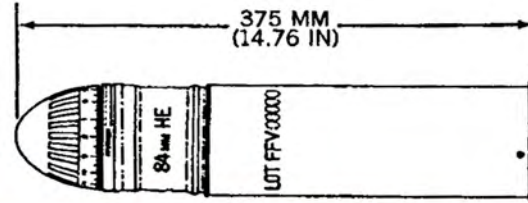

## SWEDISH PROJECTILE, 84-MM, HE-FRAG, FFV 441B

Ordnance used with:  
FFV 441B, 84-MM, CARTRIDGE, HE-FRAG  
FFV 447, PROJECTILE, MT

N.E.W. 359.00 G

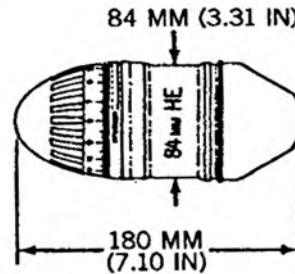

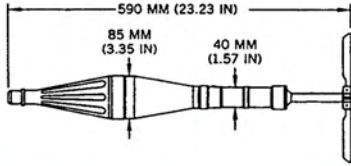

## CHINESE ROCKET, 85-MM, HEAT, TYPE 84

Ordnance used with:  
RPG-7, LNCHR.  
TYPE 69, LNCHR.

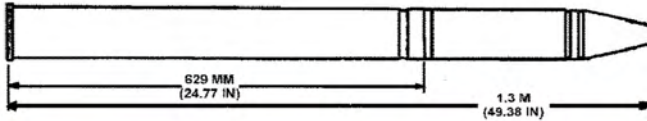

## U.S.S.R. CARTRIDGE, 85-MM, HEAT-FS, UBK-1M

Ordnance used with:  
BK-2M, 85-MM, HEAT-FS

## U.S.S.R. PROJECTILE, 85-MM, APHE-T, BR-365K

Ordnance used with:  
UBR-365K, 85-MM, CARTRIDGE, APHE-T  
MD-10, PROJECTILE, BD  
MD-7, FUZE, PROJECTILE, BD  
MD-8, PROJECTILE, BD

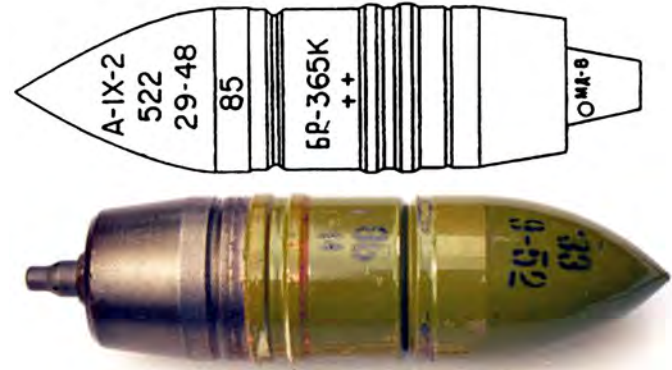

## U.S.S.R. PROJECTILE, 85-MM, FIXED, FRAG, O-365K

Ordnance used with:  
NSC-1, PROJECTILE, PDSD  
KTM-1, PROJECTILE, PD  
KTM-1U, PROJECTILE, PD  
KTM-1Y, PROJECTILE, PD  
KTM-2, PROJECTILE, PD  
KTM-3, PROJECTILE, PD  
KTM3-1, PROJECTILE, PD

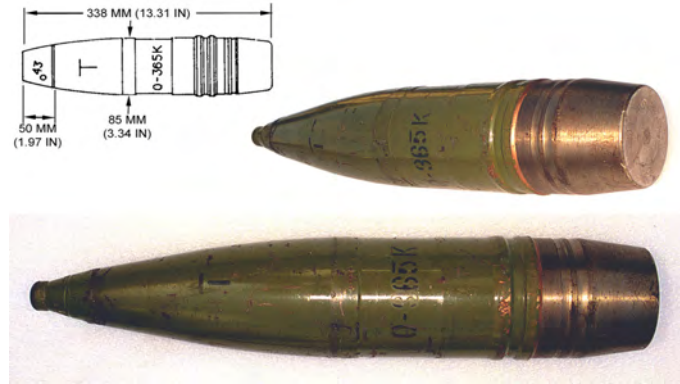

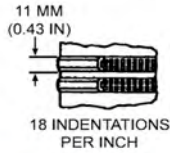
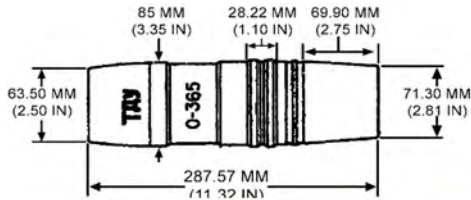

## U.S.S.R. PROJECTILE, 85-MM, HE, O-365 (ONE-PIECE)

Ordnance used with:  
 T-11, PROJECTILE, PTT  
 T-5, FUZE, PROJECTILE, PTT  
 VM-2, PROJECTILE, MT  
 UO-365, 85-MM, CARTRIDGE, HE  
 UO-365K, 85-MM, CARTRIDGE, FRAG



N.E.W. 650.00 G

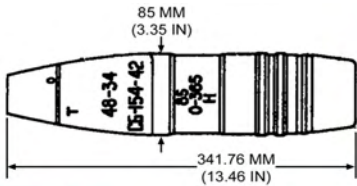

## U.S.S.R. PROJECTILE, 85-MM, HE, O-365 (TWO-PIECE)

Ordnance used with:  
 KTM-1, PROJECTILE, PD  
 KTM-1U, PROJECTILE, PD  
 KTM-1Y, PROJECTILE, PD  
 KTM-2, PROJECTILE, PD  
 KTM-3, PROJECTILE, PD  
 KTM3-1, PROJECTILE, PD  
 KTMZ-1, PROJECTILE, PD



N.E.W. 708.00 G

**U.S.S.R. PROJECTILE, 85-MM, HE, O-367A**

Ordnance used with:  
KTM-1U, PROJECTILE, PD  
KTM-1Y, PROJECTILE, PD  
UO-367A, CARTRIDGE, 85MM, FRAG

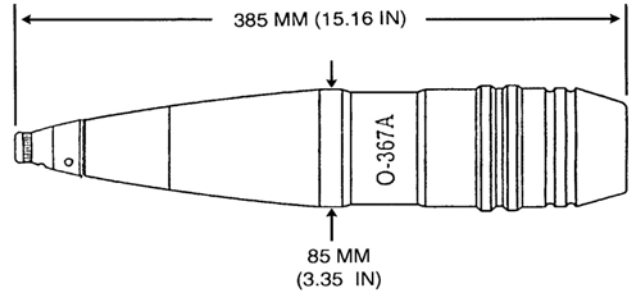

N.E.W. 670.00 G

**U.S.S.R. PROJECTILE, 85-MM, HVAP-T, BR-365P**

Ordnance used with:  
UBR-365P, CARTRIDGE, 85MM, HVAP-T

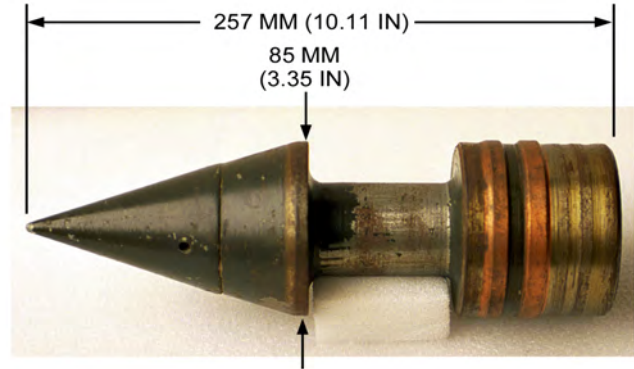

## U.S.S.R CARTRIDGE, 76-MM, UOF-354



Ordnance used with:  
KTM-1, PROJECTILE, PD  
KTM3-1, PROJECTILE, PD  
KTMZ-1, PROJECTILE, PD  
OF-350, 76-MM, HE-FRAG  
M1942 (ZIS-3), FIELD GUN, 76MM

---

## U.S.S.R. CARTRIDGE, 76-MM, FRAG-HE, UOF-354M



Ordnance used with:  
KTM-1, PROJECTILE, PD  
KTM-1U, PROJECTILE, PD  
KTM-1Y, PROJECTILE, PD  
KTM-3, PROJECTILE, PD  
KTM3-1, PROJECTILE, PD  
KTMZ-1, PROJECTILE, PD  
KTM3-1U, PROJECTILE, PD



## YUGOSLAV PROJECTILE, 90-MM, HEAT-T, M74

Ordnance used with:  
AU-16, PROJECTILE, PIBD  
M69, PROJECTILE, PIBD  
UT PE M69, PROJECTILE, PIBD  
UT-PE.M69, PROJECTILE, PIBD  
M74, 90-MM, HEAT-T, CARTRIDGE

N.E.W. 735.00 G

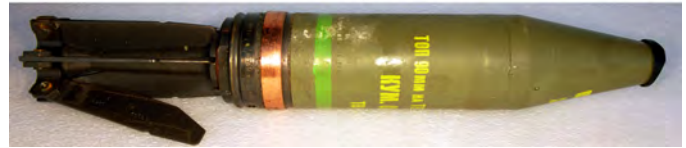
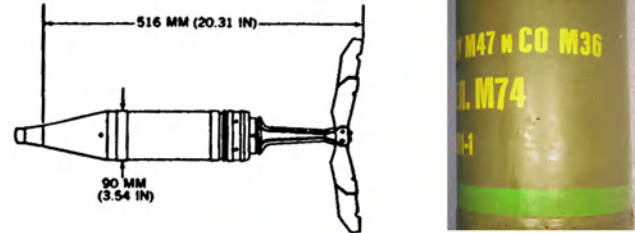

## U.S.S.R. PROJECTILE, 92-MM, INCENDIARY, (THERMOBARIC), RPO-A





## CHINESE CARTRIDGE, 57-MM, HE-T, TYPE 59

Ordnance used with:  
 ML-2  
 ML-2, PROJECTILE, PDS  
 ML2, PROJECTILE, PD  
 LIU 2, PROJECTILE, PDS  
 TYPE 59, 57MM, CARTRIDGE, HE  
 TYPE 59, 57MM, HE

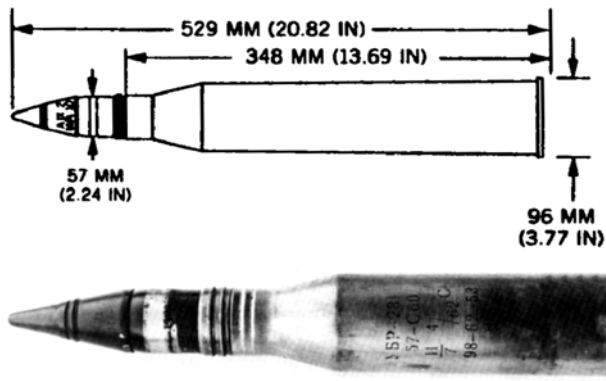

## U.S.S.R. CARTRIDGE, 57-MM, APHE-T, UBR-281

Ordnance used with:  
 MD-10, PROJECTILE, BD  
 BR-281, 57-MM, APHE-T  
 ZSU-57-2, AIR DEFENSE GUN, 57MM, TWIN  
 S-60, AIR DEFENSE GUN, 57MM, TOWED

N.E.W. 18.00 G

## U.S.S.R. CARTRIDGE, 57-MM, APHE-T, UBR-281U

Ordnance used with:  
MD-10, PROJECTILE, BD  
BR-281U, 57-MM, APHE-T  
ZSU-57-2, AIR DEFENSE GUN, 57MM, TWIN  
S-60, AIR DEFENSE GUN, 57MM, TOWED

N.E.W. 18.00 G

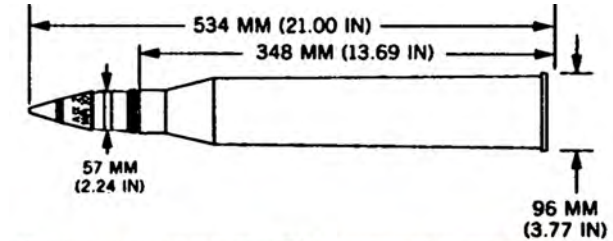

## U.S.S.R. CARTRIDGE, 57-MM, FRAG-T, OR-281U

Ordnance used with:  
MG-57, PROJECTILE, PDSD  
MGZ-57, PROJECTILE, PDSD  
OR-281U, 57-MM, FRAG-T  
ZSU-57-2, AIR DEFENSE GUN, 57MM, TWIN  
S-60, AIR DEFENSE GUN, 57MM, TOWED  
57-7N, PROJECTILE, PDSD

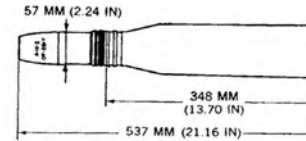

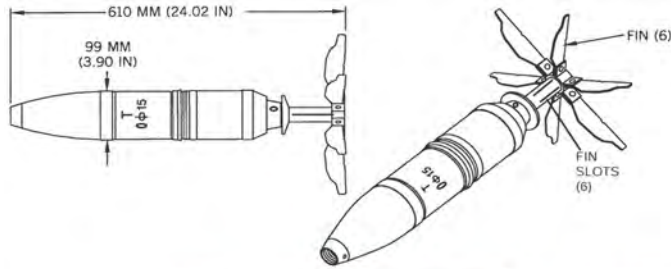

## U.S.S.R. PROJECTILE, 100-MM, FRAG-HE, OF15

Ordnance used with:  
 V-429E, PROJECTILE, PD  
 UOF-3, 100-MM, CARTRIDGE, FRAG-HE  
 UOF3, 100-MM, CARTRIDGE, HE



N.E.W. 2.23 KG

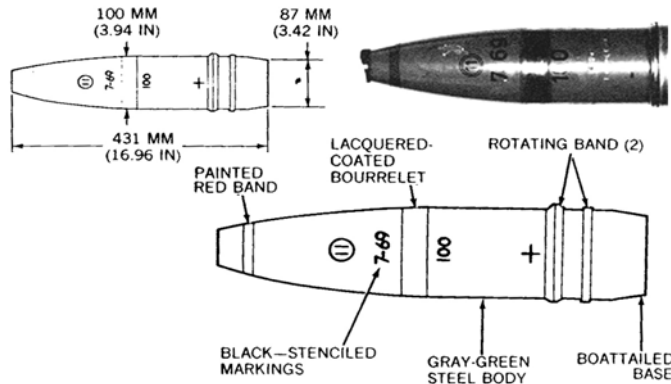

## BULGARIAN PROJECTILE, 100-MM, FRAG-HE, OF-412

Ordnance used with:  
 VUBS-1, PROJECTILE, PDS  
 NSC-1, PROJECTILE, PDS  
 RGM, PROJECTILE, PD  
 RGM-2, PROJECTILE, PD  
 RGM-3, PROJECTILE, PD  
 RGM-6, PROJECTILE, PD  
 UTIU M63P2, PROJECTILE, PD

## BULGARIAN PROJECTILE, 100-MM, HEAT, BK5

Ordnance used with:  
GPV-2, PROJECTILE, PIBD, SPITBACK  
UAPHC4, CARTRIDGE, 100MM, HEAT-T-FS  
UBK-4, CARTRIDGE, 100MM, HEAT

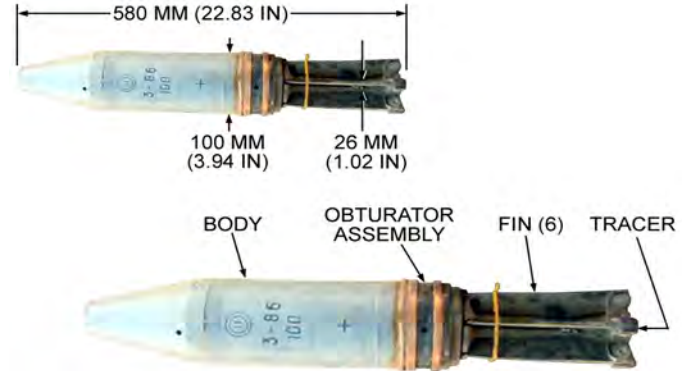

## CZECHOSLOVAKIAN PROJECTILE, 100-MM, APHE-T, PSV

Ordnance used with:  
JPSV CARTRIDGE, 100-MM, APHE-T  
DBR-2, PROJECTILE, BD  
DZ 30, PROJECTILE, BD  
PD 30, PROJECTILE, BD

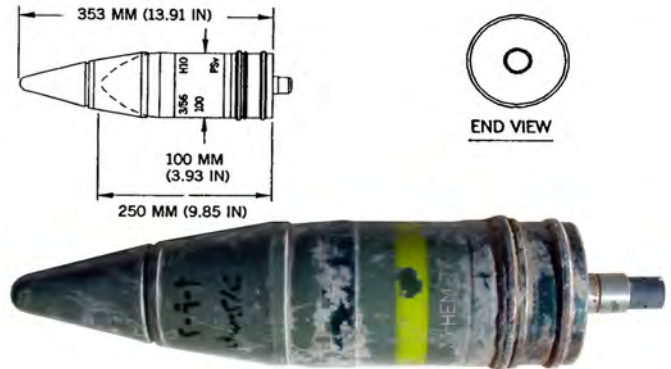

N.E.W. 96.00 G

**PAKISTANI CARTRIDGE, 100-MM, APFSDS-T, 100-MM APFSDS-T**

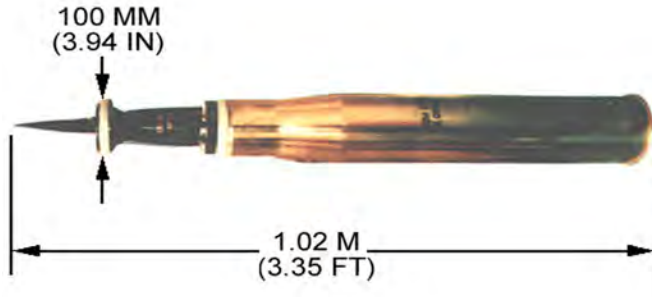

**RUSSIAN PROJECTILE, 100-MM, HEAT-T, 3BK17M**

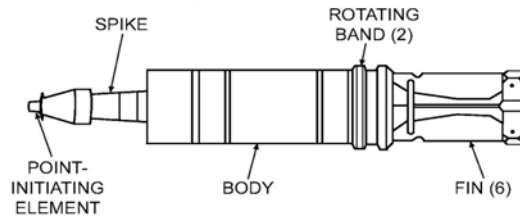
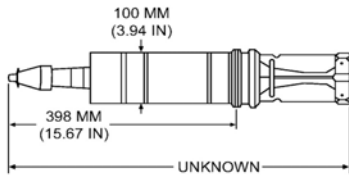

Ordnance used with:  
3UBK9, CARTRIDGE, 100-MM, HEAT-FS  
V-15, FUZE, PROJECTILE, PIBD  
UBK-9M, CARTRIDGE, 100MM, HEAT

**U.S.S.R. CARTRIDGE, 100-MM, 3UBM10 WITH PROJECTILE, APFSDS, 3BM24**

Ordnance used with:  
 3BM24, 100-MM, APFSDS  
 BM-24, 100-MM, APFSDS  
 3UBM10, CARTRIDGE, 100-MM, APFSDS  
 UBM-10, CARTRIDGE, 100-MM, APFSDS

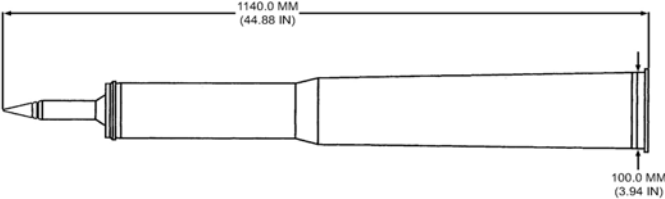

**U.S.S.R. CARTRIDGE, 100-MM, FRAG-HE, 3UOF10 (UOF-10)**

Ordnance used with:  
 UTIU M63P2, PROJECTILE, PD  
 V-429, PROJECTILE, PD  
 V-429E, PROJECTILE, PD  
 3OF32, 100-MM, HE  
 OF-32, 100-MM, FRAG-HE

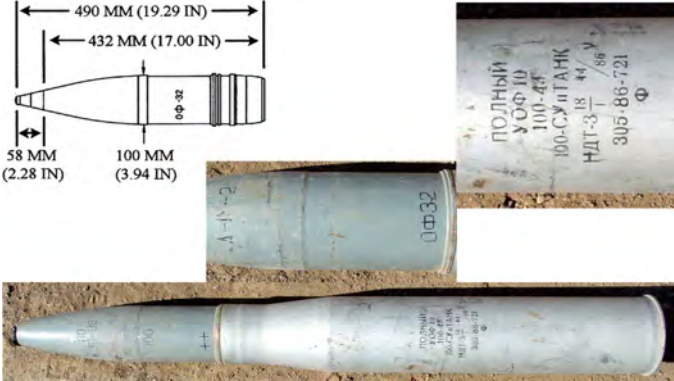

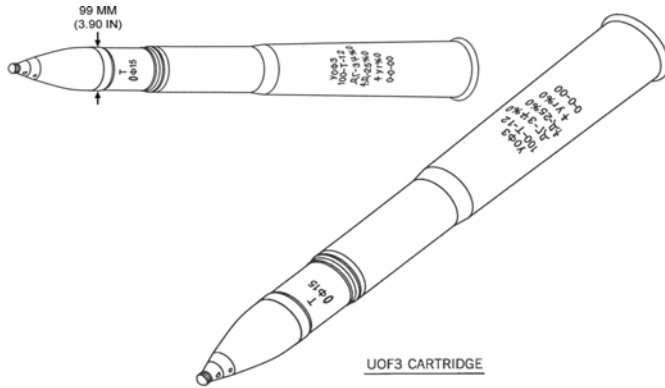

### U.S.S.R. CARTRIDGE, 100-MM, FRAG-HE, UOF-3

Ordnance used with:  
V-429E, PROJECTILE, PD  
OF15, 100-MM, FRAG-HE  
OF15, 100-MM, HE

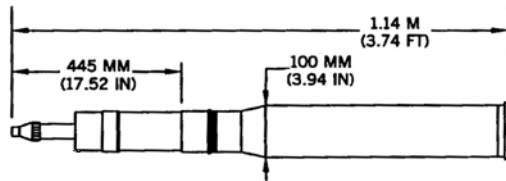

### U.S.S.R. CARTRIDGE, 100-MM, HEAT-FS, 3BK9

Ordnance used with:  
3BK17M, 100-MM, HEAT-T  
BK-17M

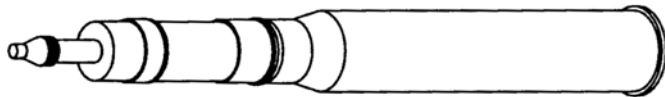



## U.S.S.R. CARTRIDGE, 100-MM, HVAPDS-T, UBM-6

Ordnance used with:  
BM-8, 100-MM, HVAPDS-T  
BM8, 100-MM, HVAPDS-T

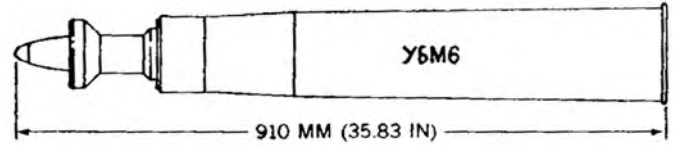

---

## U.S.S.R. PROJECTILE, 100-MM, APHE OR APHE-T, BR-412B

Ordnance used with:  
DBR, PROJECTILE, BD  
DBR-2, PROJECTILE, BD  
UBR-412B, CARTRIDGE, 100MM, APHE-T  
UBZR, CARTRIDGE, 100-MM, APHE-T  
MD-8, PROJECTILE, BD  
UBR-412, CARTRIDGE, 100-MM, APHE OR APHE-T

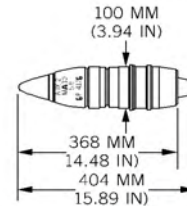

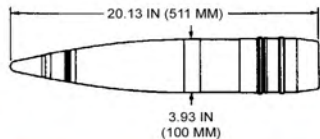

## U.S.S.R. PROJECTILE, 100-MM, FRAG, O-415

Ordnance used with:  
 KTM-1, PROJECTILE, PD  
 VM-30, PROJECTILE, MT  
 VM-30L, PROJECTILE, MT  
 UO-415, 100MM, CARTRIDGE, FRAG

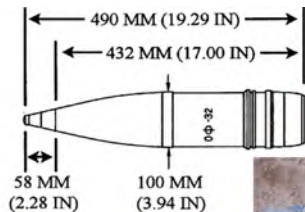

## U.S.S.R. PROJECTILE, 100-MM, FRAG-HE, OF-32

Ordnance used with:  
 UTIU M63P2, PROJECTILE, PD  
 V-429, PROJECTILE, PD  
 V-429E, PROJECTILE, PD  
 3UOF10, 100-MM, CARTRIDGE, FRAG-HE  
 UOF-10, 100-MM, CARTRIDGE, HE

N.E.W. 1.70 KG

## U.S.S.R. PROJECTILE, 100-MM, FRAG-HE, OF-412

Ordnance used with:  
NSC-1, PROJECTILE, PSD  
RGM, PROJECTILE, PD  
RGM-2, PROJECTILE, PD  
RGM-3, PROJECTILE, PD  
RGM-6, PROJECTILE, PD  
UTIU M63P2, PROJECTILE, PD  
V-429, PROJECTILE, PD

N.E.W. 1.46 KG

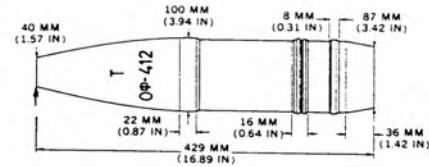

## U.S.S.R. PROJECTILE, 100-MM, HEAT, 3BK16M

Ordnance used with:  
3UBK8, 100-MM, CARTRIDGE, HEAT-FS  
V-15, FUZE, PROJECTILE, PIBD  
UBK-8M, CARTRIDGE, 100MM, HEAT

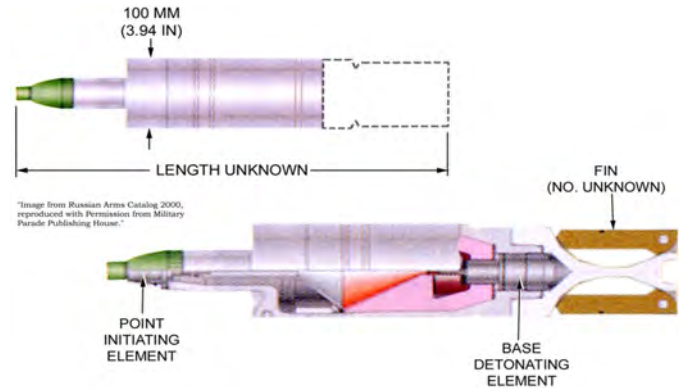

## U.S.S.R. PROJECTILE, 100-MM, HEAT-FS, 3BK-5M

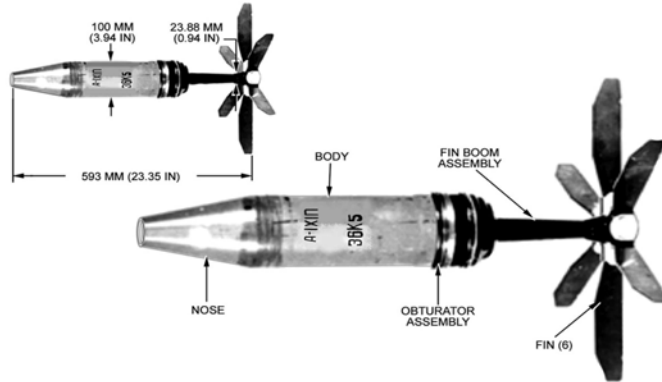

Ordnance used with:  
GPV-2, PROJECTILE, PIBD, SPITBACK  
UBK-4M, CARTRIDGE, 100-MM, HEAT-FS

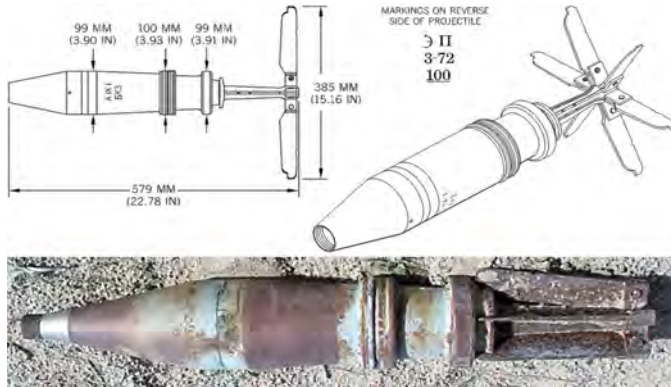

## U.S.S.R. PROJECTILE, 100-MM, HEAT-FS-T, BK-3

Ordnance used with:  
GPV-2, PROJECTILE, PIBD, SPITBACK  
GPV-3, PROJECTILE, PIBD  
UBK-2, 100MM, CARTRIDGE, HEAT

## U.S.S.R. PROJECTILE, 100-MM, HVAPDS-T, BM8

Ordnance used with:  
UBM-6, 100-MM, CARTRIDGE, HVAPDS-T

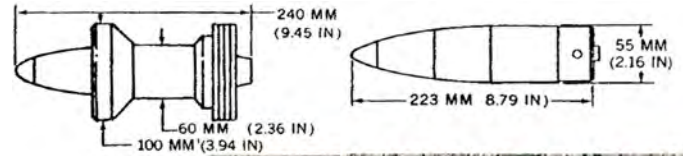

## YUGOSLAV PROJECTILE, 100-MM, HEAT-T, M69

Ordnance used with:  
AU-16, PROJECTILE, PIBD  
M69, PROJECTILE, PIBD  
UT PE M69, PROJECTILE, PIBD  
UT-PE.M69, PROJECTILE, PIBD  
M69, 100-MM, HEAT-T, CARTRIDGE



## U.S.S.R. CARTRIDGE, 85-MM, APHE-T, UBR-365K



Ordnance used with:  
BR-365K, 85 MM, APHE-T  
MD-10, PROJECTILE, BD  
MD-5, PROJECTILE, BD  
MD-7, FUZE, PROJECTILE, BD  
MD-8, PROJECTILE, BD  
KS-12, AIR DEFENSE GUN, 85MM, TOWED

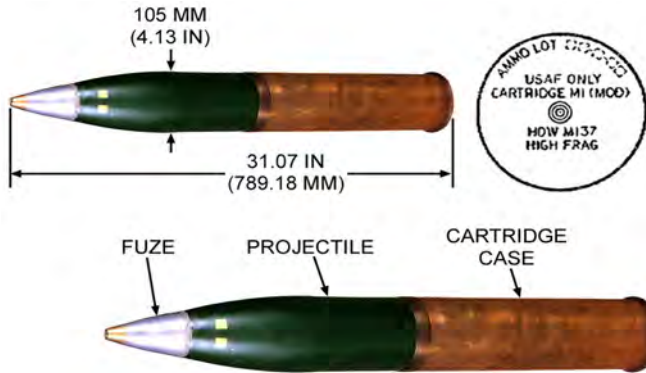

## U.S. CARTRIDGE, 105-MM, HE, HIGH FRAG M1 (MOD)

Ordnance used with:  
M557, FUZE, PROJECTILE, PD  
M732 PROJECTILE, PROX.  
MK 399 MOD 1, FUZE, PROJECTILE, PD  
FMU-153/B PROJECTILE, PD  
M732A2, PROJECTILE, PROX.  
M732E2, PROJECTILE, PROX.  
FMU-160/B PROJECTILE, PROX.  
N.E.W. 3.62 KG

## U.S. CARTRIDGE, 105-MM, HE, M1 (MOD)

Ordnance used with:

M557, FUZE, PROJECTILE, PD

M732 PROJECTILE, PROX.

MK 399 MOD 1, FUZE, PROJECTILE, PD

MK 407 MOD 1, FUZE, PROJECTILE, PD

M1 (MOD), PROJECTILE, 105MM, HE

FMU-153/B PROJECTILE, PD

M732A2, PROJECTILE, PROX.

N.E.W. 3.39 KG



## U.S. CARTRIDGE, 105-MM, HE, M760

Ordnance used with:

M582, FUZE, PROJECTILE, MTSQ

M582A1, FUZE, PROJECTILE, MTSQ

M732 PROJECTILE, PROX.

M739, FUZE, PROJECTILE, PD

M739A1, FUZE, PROJECTILE, PD

M760, 105-MM, HE

MK 399 MOD 1, FUZE, PROJECTILE, PD

N.E.W. 2.18 KG

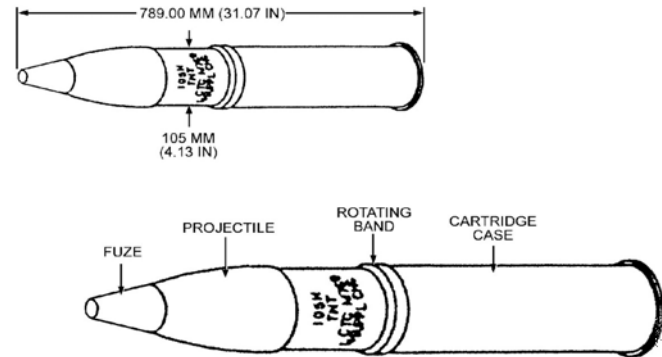

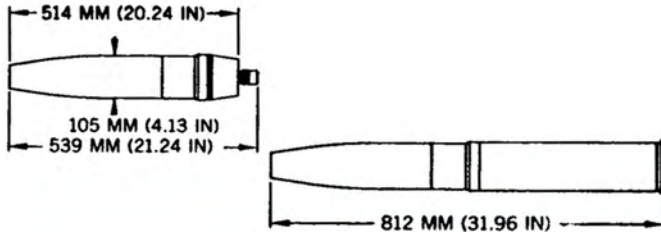

## U.S. CARTRIDGE, 105-MM, HERA, M913

Ordnance used with:

M582, FUZE, PROJECTILE, MTSQ  
 M582A1, FUZE, PROJECTILE, MTSQ  
 M728, FUZE, PROJECTILE, PROX.  
 M732 PROJECTILE, PROX.  
 M739, FUZE, PROJECTILE, PD  
 MK 399 MOD 1, FUZE, PROJECTILE, PD  
 M767, FUZE, PROJECTILE, ET

N.E.W. 5.76 KG

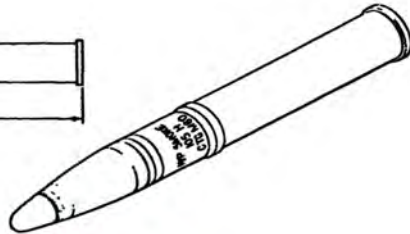
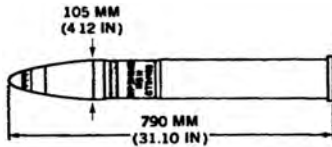

## U.S. CARTRIDGE, 105-MM, SMOKE, WP, M60A1

Ordnance used with:

M508, PROJECTILE, PD  
 M508A1, PROJECTILE, PD  
 M51A5, FUZE, PROJECTILE, PD  
 M55, PROJECTILE, TSQ  
 M557, FUZE, PROJECTILE, PD  
 M55A2, FUZE, PROJECTILE, TSQ  
 M55A3, FUZE, PROJECTILE, TSQ

N.E.W. 3.00 LB



## U.S. PROJECTILE, 105-MM, HE, HF M1 (MOD)

Ordnance used with:  
M501, FUZE, PROJECTILE, MTSQ  
M501A1, FUZE, PROJECTILE, MTSQ  
M557, FUZE, PROJECTILE, PD  
M564, FUZE, PROJECTILE, MTSQ  
M732 PROJECTILE, PROX.  
MK 399 MOD 1, FUZE, PROJECTILE, PD  
FMU-153/B PROJECTILE, PD

N.E.W. 2.30 KG

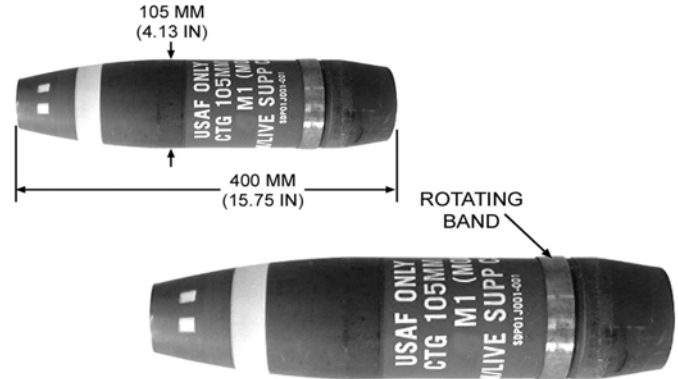

## U.S. PROJECTILE, 105-MM, HE, M1 (MOD)

Ordnance used with:  
M501, FUZE, PROJECTILE, MTSQ  
M501A1, FUZE, PROJECTILE, MTSQ  
M557, FUZE, PROJECTILE, PD  
M564, FUZE, PROJECTILE, MTSQ  
M732 PROJECTILE, PROX.  
MK 399 MOD 1, FUZE, PROJECTILE, PD  
MK 407 MOD 1, FUZE, PROJECTILE, PD

N.E.W. 2.22 KG

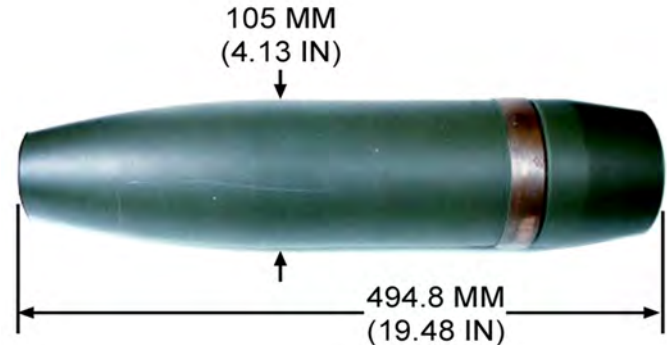

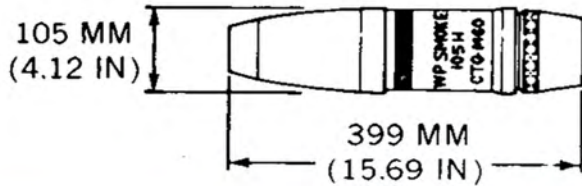

## U.S. PROJECTILE, 105-MM, SMOKE, WP, M60-SERIES

Ordnance used with:

- M501, FUZE, PROJECTILE, MTSQ
- M501A1, FUZE, PROJECTILE, MTSQ
- M508, PROJECTILE, PD
- M508A1, PROJECTILE, PD
- M51A5, FUZE, PROJECTILE, PD
- M55, PROJECTILE, TSQ
- M557, FUZE, PROJECTILE, PD

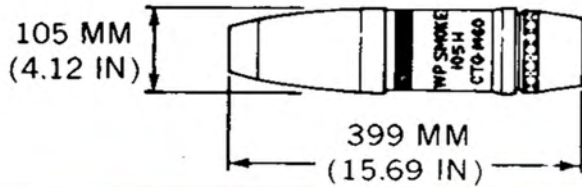

## U.S. PROJECTILE, 105-MM, SMOKE, WP, M60A2

Ordnance used with:

- M501, FUZE, PROJECTILE, MTSQ
- M501A1, FUZE, PROJECTILE, MTSQ
- M508, PROJECTILE, PD
- M508A1, PROJECTILE, PD
- M51A5, FUZE, PROJECTILE, PD
- M55, PROJECTILE, TSQ
- M557, FUZE, PROJECTILE, PD



## U.S.S.R. PROJECTILES, 107-MM, HE, FRAG, OF-841 & OF-841A

Ordnance used with:  
D-1, PROJECTILE, TSQ  
GVM, FUZE, PROJECTILE, PD  
GVMZ, FUZE, PROJECTILE, PD  
GVMZ-1, FUZE, PROJECTILE, PD  
GVMZ-7, PROJECTILE, PD

N.E.W. 2.10 KG

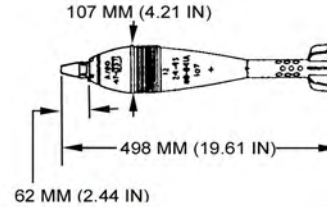

## CHINESE CARTRIDGE, 75-MM, RR, HEAT, TYPE 52

Ordnance used with:  
TYPE 52, 75 MM, RR, HEAT

N.E.W. 1.05 KG

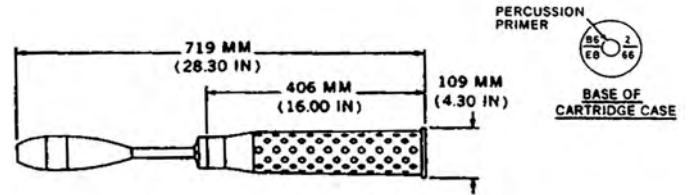

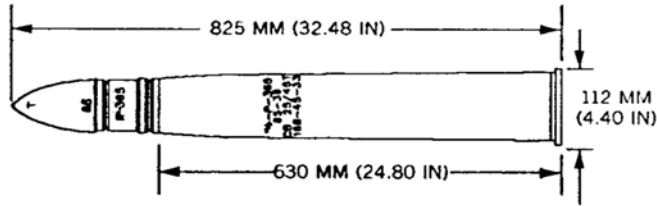

### U.S.S.R. CARTRIDGE, 85-MM, APHE-T, UBR-365

Ordnance used with:  
 BR-365, 85-MM, APHE-T  
 MD-10, PROJECTILE, BD  
 MD-8, PROJECTILE, BD  
 KS-12, AIR DEFENSE GUN, 85MM, TOWED

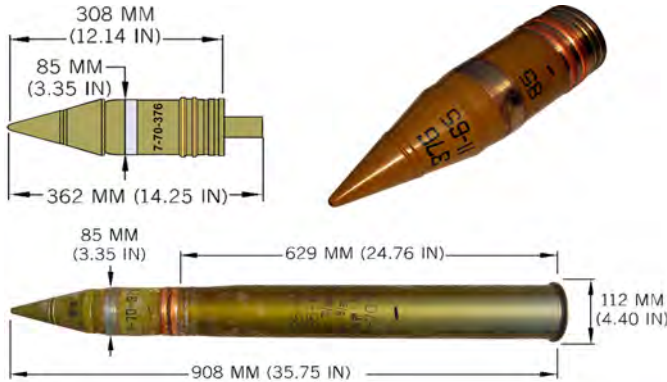

### U.S.S.R. CARTRIDGE, 85-MM, APHE-T, UBR-367 WITH PROJECTILE BR-367

Ordnance used with:  
 TYPE 367, 85-MM, CARTRIDGE, APHE-T  
 UBR-367, 85-MM, CARTRIDGE, APHE-T  
 BR-367, 85-MM, APHE-T  
 TYPE 367, 85-MM, APHE-T  
 TYPE 376, 85-MM, APHE-T  
 DBR, PROJECTILE, BD  
 DBR-2, PROJECTILE, BD  
 N.E.W. 127.00 G

## U.S.S.R. CARTRIDGE, 85-MM, FRAG, UO-365K

Ordnance used with:  
O-365, 85-MM, PROJECTILE, HE, (2 PIECE)  
O-365K, 85-MM, FRAG  
KTM-1, PROJECTILE, PD  
KTM-1U, PROJECTILE, PD  
KTM-1Y, PROJECTILE, PD  
KTM3-1, PROJECTILE, PD  
KTMZ-1, PROJECTILE, PD

N.E.W. 3.39 KG

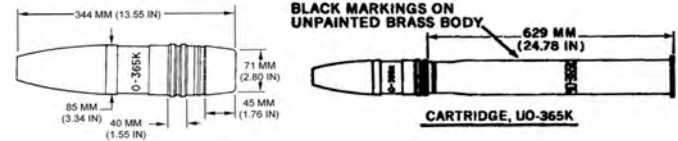

## U.S.S.R. CARTRIDGE, 85-MM, HE, UO-365

Ordnance used with:  
O-365, 85-MM, PROJECTILE, HE, (2 PIECE)  
KTM3-1, PROJECTILE, PD  
KTMZ-1, PROJECTILE, PD  
T-11, PROJECTILE, PTT  
T-5, FUZE, PROJECTILE, PTT  
VM-2, PROJECTILE, MT  
O-365 (ONE-PIECE), 85-MM, HE-FRAG



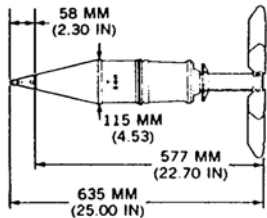

**U.S.S.R. CARTRIDGE, 115-MM, FRAG, HE, UOF-1**

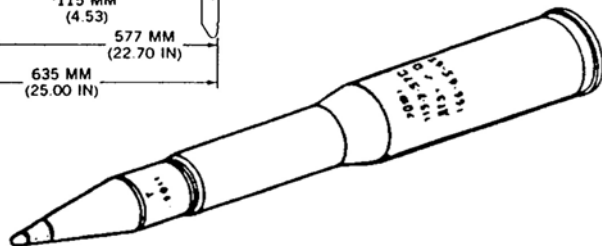

Ordnance used with:  
 OF-11, 115-MM, FRAG-HE  
 V-429E, PROJECTILE, PD



FRONT



REVERSE



CARTRIDGE CASE

**U.S.S.R. CARTRIDGE, 115-MM, FRAG-HE, 3UOF37 (UOF-37)**

Ordnance used with:  
 30F27, 115-MM, FRAG-HE  
 OF-27, 115-MM, FRAG-HE  
 V-429E, PROJECTILE, PD

MARKINGS



**U.S.S.R. CARTRIDGE, 115-MM, HEAT-FS, 3UBK7 W/  
PROJECTILE, MODEL UNKNOWN**

Ordnance used with:  
V-15, FUZE, PROJECTILE, PIBD  
3BK15M, 115-MM, HEAT  
BK-15M, 115-MM, HEAT

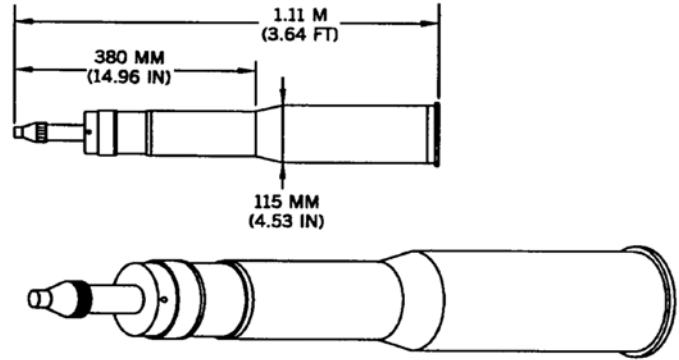

**U.S.S.R. PROJECTILE, 115-MM, FRAG, HE, OF-11**

Ordnance used with:  
UTIU M63P2, PROJECTILE, PD  
V-429, PROJECTILE, PD  
V-429E, PROJECTILE, PD  
UOF-1, CARTRIDGE, 115-MM, FRAG, HE

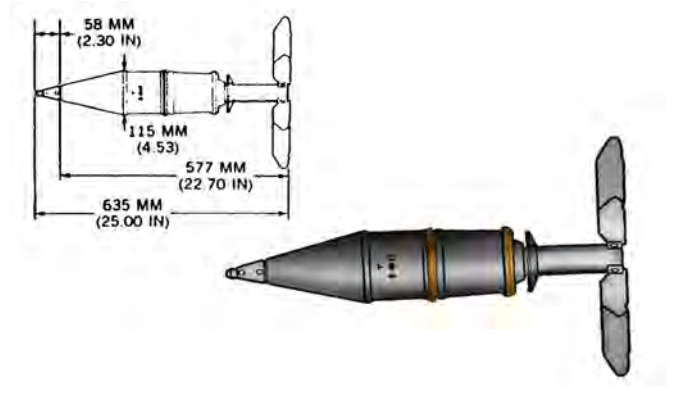

## U.S.S.R. PROJECTILE, 115-MM, FRAG-HE, OF-27



Ordnance used with:  
V-429E, PROJECTILE, PD  
3UOF37, 115-MM, CARTRIDGE, FRAG-HE  
UOF-37, 115-MM, CARTRIDGE, FRAG-HE

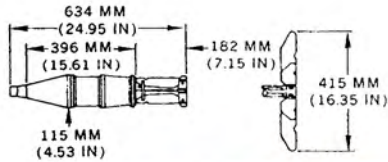

## U.S.S.R. PROJECTILE, 115-MM, FS, HEAT, BK-4M

Ordnance used with:  
GPV-2, PROJECTILE, PIBD, SPITBACK  
UBK-3, 115MM, CARTRIDGE, HEAT-T  
UBK-3M, 115MM, CARTRIDGE, FS, HEAT

N.E.W. 1.46 KG



## U.S.S.R. PROJECTILE, 115-MM, HE, FRAG, OF-18

Ordnance used with:  
UTIU M63P2, PROJECTILE, PD  
V-429, PROJECTILE, PD  
V-429E, PROJECTILE, PD  
D-1-U, PROJECTILE, TSQ  
D-1U, PROJECTILE, TSQ  
UOF-6, 115-MM, CARTRIDGE, HE, FRAG

N.E.W. 2.70 KG

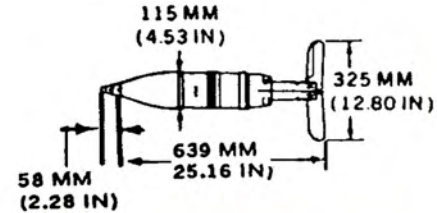

## U.S.S.R. PROJECTILE, 115-MM, HEAT, 3BK15M

Ordnance used with:  
3UBK7, CARTRIDGE, 115-MM, HEAT-FS  
UBK-7, CARTRIDGE, 115-MM, HEAT-FS  
V-15, FUZE, PROJECTILE, PIBD

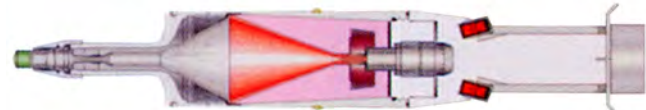

"Image from Russian Arms Catalog,  
Vol. VII, reproduced with Permission  
from Military Parade Publishing House."

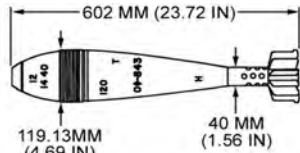

## U.S.S.R. PROJECTILE, 120-MM, HE, MORTAR, OF-843

Ordnance used with:  
 GVM, FUZE, PROJECTILE, PD  
 GVMZ, FUZE, PROJECTILE, PD  
 GVMZ-1, FUZE, PROJECTILE, PD  
 GVMZ-7, PROJECTILE, PD  
 M-1, PROJECTILE, PDSQ  
 TYPE 1, PROJECTILE, PD  
 M-12, FUZE, PROJECTILE, PD  
 N.E.W. 2.68 KG

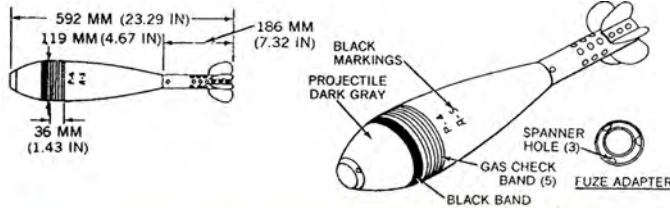

## U.S.S.R. PROJECTILE, 120-MM, MORTAR, SMOKE (WP) D-5

Ordnance used with:  
 M-12, FUZE, PROJECTILE, PD  
 MP-4, FUZE, PROJECTILE, PD  
 M-4, PROJECTILE, PD



**CHINESE PROJECTILE, 120-MM, MORTAR,  
ILLUMINATING, MODEL UNKNOWN**

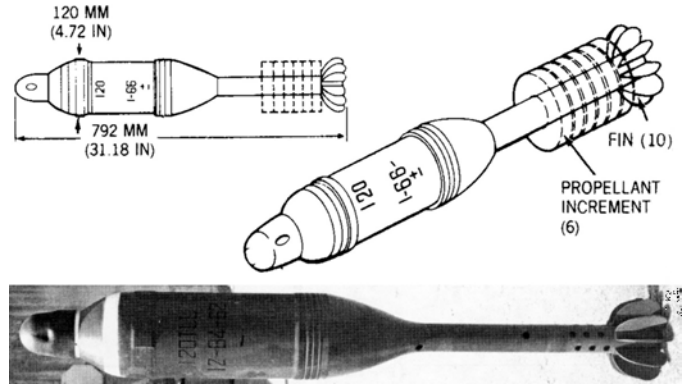

N.E.W. 2.10 KG

**IRANIAN CARTRIDGE, 120-MM, HE, MORTAR, MODEL  
UNKNOWN**

Ordnance used with:  
AZ111 A2, PROJECTILE, PD  
AZ111-A2  
AZ111, PROJECTILE, PD  
DM111, PROJECTILE, PD  
UNKNOWN, 120MM, MORTAR, HE

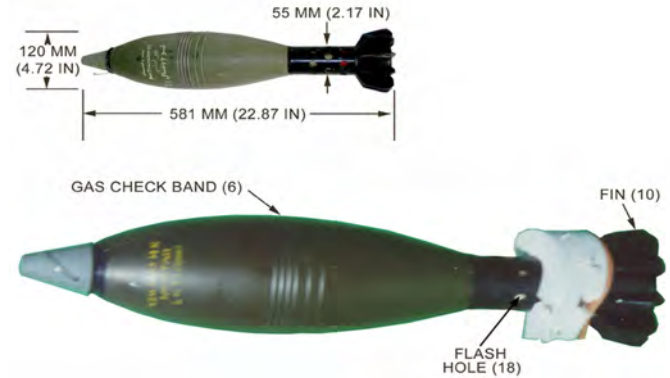

N.E.W. 2.30 KG

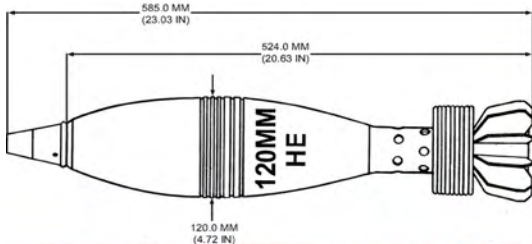

## IRANIAN PROJECTILE, 120-MM, HE, MORTAR, MODEL UNKNOWN

Ordnance used with:  
 AZ111 A2, PROJECTILE, PD  
 AZ111-A2  
 AZ111, PROJECTILE, PD  
 DM111, PROJECTILE, PD  
 MDL. UNKNOWN, CARTRIDGE, 120MM, HE, MORTAR



N.E.W. 2.30 KG

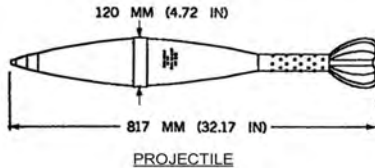

## SPANISH CARTRIDGE, 120-MM, MORTAR, HE, AE-100

Ordnance used with:  
 M734 PROJECTILE, MULTIOPTION



## U.S.S.R. CARTRIDGE, 120-MM, MORTAR, ILLUM, S-843

Ordnance used with:  
S-843, 120-MM, MORTAR, ILLUMINATION  
T-1, PROJECTILE, TSQ

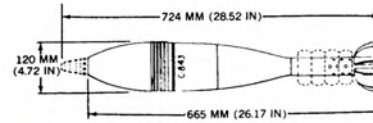

N.E.W. 367.00 G

## U.S.S.R. PROJECTILE, 115-MM, HVAP-FS-DS-T BM-6

Ordnance used with:  
UBM-5, 115MM, CARTRIDGE, APFSDS-T

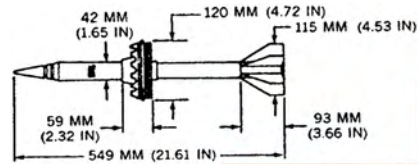

## U.S.S.R. PROJECTILE, 120-MM, HE, MORTAR, OF-843B

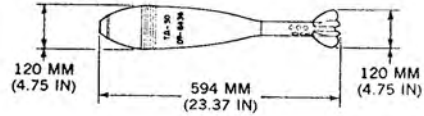

Ordnance used with:  
GVMZ-7, PROJECTILE, PD  
M-12, FUZE, PROJECTILE, PD  
MP-4, FUZE, PROJECTILE, PD  
V-22, FUZE, PROJECTILE, PD  
MP-4, PROJECTILE, PD  
M-12 (MODIFIED), FUZE, PROJECTILE, PD

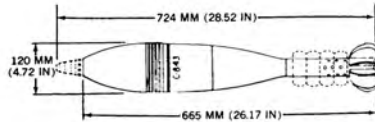

## U.S.S.R. PROJECTILE, 120-MM, MORTAR, ILLUM, S-843

Ordnance used with:  
T-1, PROJECTILE, TSQ  
S-843, 120-MM, MORTAR, CARTRIDGE, ILLUMINATION

## YUGOSLAV CARTRIDGE, 120-MM, HE, MORTAR, M62P3

Ordnance used with:  
AU-29, PROJECTILE, PD  
UTU M78, PROJECTILE, PD  
UT M68 P1, PROJECTILE, PD  
UT M68P1, PROJECTILE, PD  
UT.M68 P1, PROJECTILE, PD  
MU K92, PROJECTILE, PD  
UT M93, PROJECTILE, PD

N.E.W. 2.30 KG

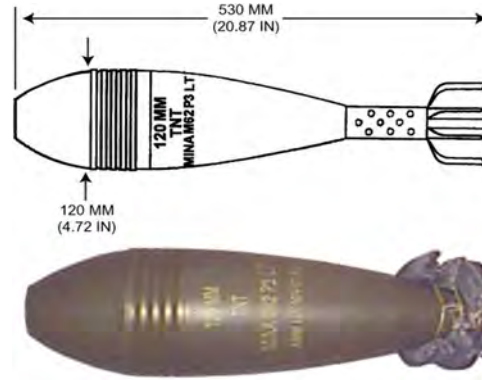

## U.S.S.R. PROJECTILE, 122-MM, SMOKE, WP, D-4

Ordnance used with:  
RGM-2, PROJECTILE, PD  
RGM-3, PROJECTILE, PD  
ZH10, 122MM, PROPELLING CHARGE, REDUCED  
ZH-9, 122 MM, PROPELLING CHARGE  
ZH-9, 122MM, PROPELLING CHARGE, FULL

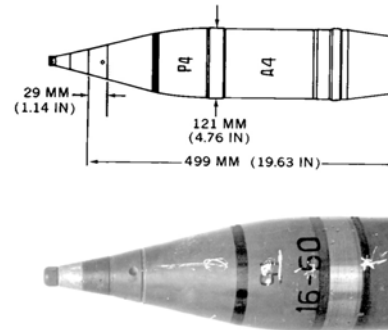

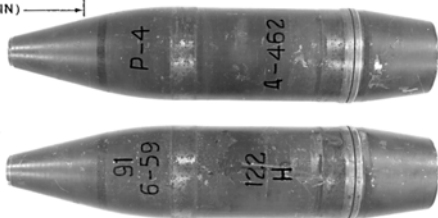
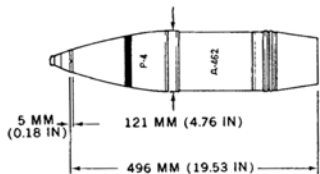

## U.S.S.R. PROJECTILE, 122-MM, SMOKE, WP, D-462

Ordnance used with:  
 KT-1, FUZE, PROJECTILE, PD  
 KT-2, FUZE, PROJECTILE, PD  
 KT-3, FUZE, PROJECTILE, PD  
 KTM-1, PROJECTILE, PD  
 KTM-1U, PROJECTILE, PD  
 KTM-1Y, PROJECTILE, PD  
 KTM-2, PROJECTILE, PD

N.E.W. 158.00 G



## CHINESE PROJECTILE, 122-MM, HE, TYPE 54

Ordnance used with:  
 DRL08, PROJECTILE, PDSQ  
 MD-82  
 MD82, PROJECTILE, PROX.  
 ML-4  
 ML4, PROJECTILE, PD  
 ML-5  
 ML5, PROJECTILE, PD

N.E.W. 4.30 KG



**CHINSESE PROJECTILE, 122-MM, HE, BB, MODEL UNKNOWN**

Ordnance used with:  
ML-4A  
ML4A, PROJECTILE, PD  
TYPE 83 CARTRIDGE, 122-MM, HE-FRAG, BB



N.E.W. 3.40 KG

---

**EGYPTIAN PROJECTILE, 122-MM, HE, H/38**

Ordnance used with:  
AU-18, PROJECTILE, PD  
UTIU M71, PROJECTILE, PD  
H/38, CARTRIDGE, 122MM, HE  
M362, PROJECTILE, PD



N.E.W. 3.50 KG

---

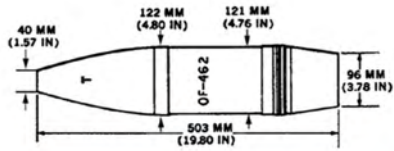

## POLISH PROJECTILE, 122-MM, HE-FRAG, OF-462

Ordnance used with:  
 RG-6, PROJECTILE, PD  
 RGM, PROJECTILE, PD  
 RGM-2, PROJECTILE, PD  
 RGM-2M, PROJECTILE, PD  
 RGM-3, PROJECTILE, PD  
 RGM-6, PROJECTILE, PD  
 D30, 122MM, HOWITZER, TOWED

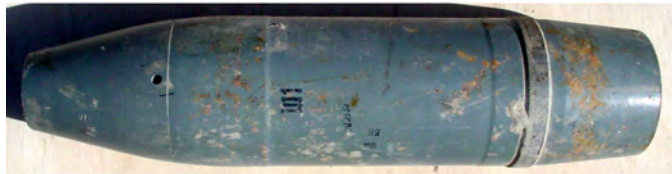

## U.S.S.R. PROJECTILE, 122-MM, FLECHETTE, SH1 (SH-1)

## U.S.S.R. PROJECTILE, 122-MM, FRAG, HE, OF-46ZH

Ordnance used with:  
RGM, PROJECTILE, PD  
RGM-2, PROJECTILE, PD  
RGM-3, PROJECTILE, PD

N.E.W. 3.46 KG

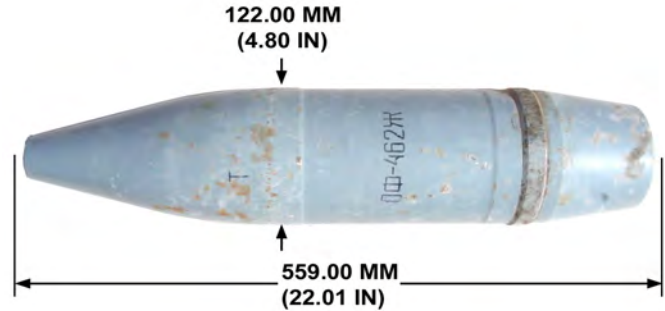

## U.S.S.R. PROJECTILE, 122-MM, FRAG-HE, OF-56

Ordnance used with:  
PF 122, PROJECTILE, PROXIMITY/PD  
PF-122, PROJECTILE, PROXIMITY/PD  
PF122, PROJECTILE, PROXIMITY/PD  
D-1, PROJECTILE, TSQ  
RGM-2, PROJECTILE, PD  
RGM-2M, PROJECTILE, PD  
RGM-3, PROJECTILE, PD

N.E.W. 4.40 KG

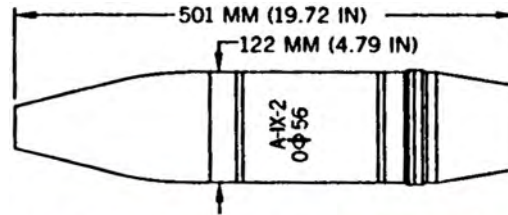

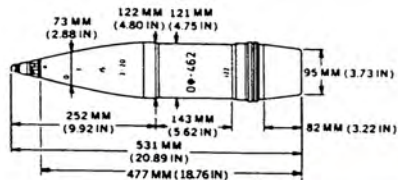

## U.S.S.R. PROJECTILE, 122-MM, HE, FRAG, OF-462

Ordnance used with:

- D-1, PROJECTILE, TSQ
- GVM, FUZE, PROJECTILE, PD
- GVMZ, FUZE, PROJECTILE, PD
- GVMZ-1, FUZE, PROJECTILE, PD
- RG-6, PROJECTILE, PD
- RGM, PROJECTILE, PD
- RGM-2, PROJECTILE, PD

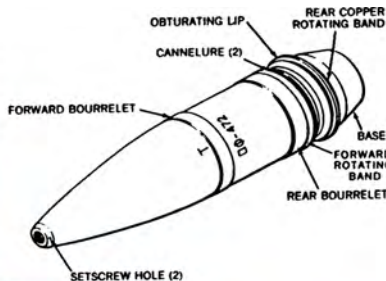
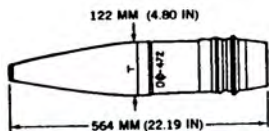

## U.S.S.R. PROJECTILE, 122-MM, HE, FRAG, OF-472

Ordnance used with:

- D-1, PROJECTILE, TSQ
- RGM-2, PROJECTILE, PD
- RGM-6, PROJECTILE, PD
- AR 7 (SIGNAL), PROJECTILE, PROXIMITY/PD
- UTIU M63P2, PROJECTILE, PD
- V-429, PROJECTILE, PD
- V-429E, PROJECTILE, PD

N.E.W. 3.00 KG

## U.S.S.R. PROJECTILE, 122-MM, HE-FRAG, OF-462A

Ordnance used with:  
 RG-6, PROJECTILE, PD  
 RGM, PROJECTILE, PD  
 RGM-2, PROJECTILE, PD  
 RGM-6, PROJECTILE, PD  
 D-1-U, PROJECTILE, TSQ  
 D-1U, PROJECTILE, TSQ  
 ZH-463, 122MM, PROPELLING CHARGE

N.E.W. 3.22 KG

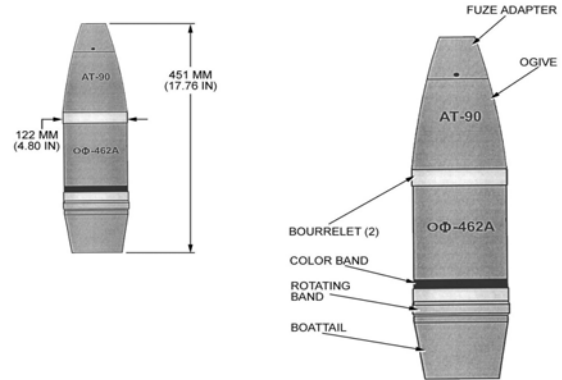

## U.S.S.R. PROJECTILE, 122-MM, HEAT-FS, BK 13

Ordnance used with:  
 V-15, FUZE, PROJECTILE, PIBD  
 ZH-9, 122 MM, PROPELLING CHARGE  
 ZH-9, 122MM, PROPELLING CHARGE, FULL  
 3UBK-9, 122-MM, CARTRIDGE, HEAT-FS-T  
 VBK9, 122MM, CARTRIDGE, HEAT-T

N.E.W. 1.81 KG

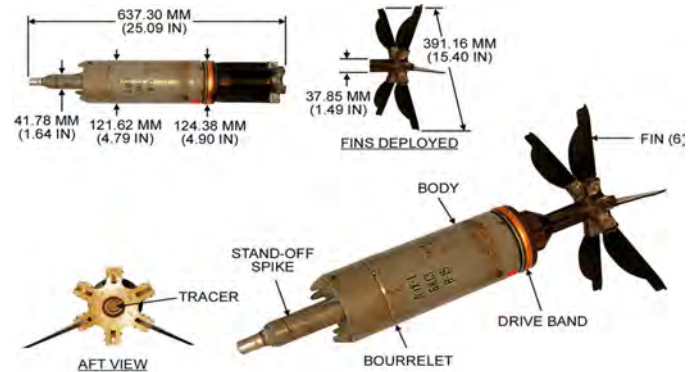

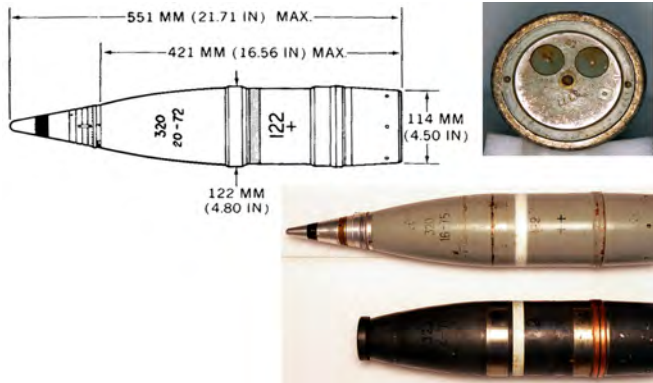

## U.S.S.R. PROJECTILE, 122-MM, ILLUM, S-463 & S-463ZH

Ordnance used with:

T-6, FUZE, PROJECTILE, TSQ

T-7, FUZE, PROJECTILE, TIME OR TSQ

T-90, PROJECTILE, MT

ZH-9, 122 MM, PROPELLING CHARGE

ZH-9, 122MM, PROPELLING CHARGE, FULL

ZH-463, 122MM, PROPELLING CHARGE

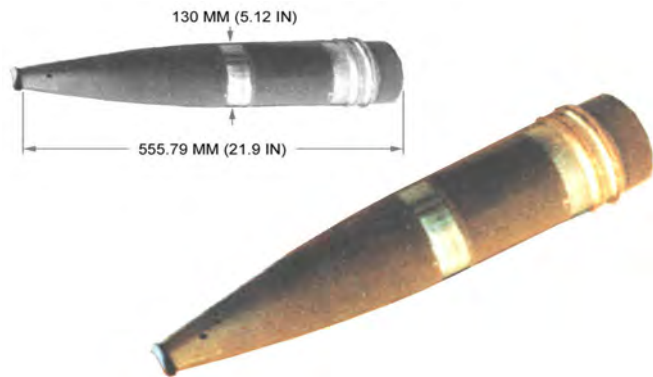

## CHINESE PROJECTILE, 130-MM, HE, AND HEI, TYPE 59

Ordnance used with:

TYPE 59, 130MM, PROPELLING CHARGE, REDUCED VA...

ZH 482U, 130MM, PROPELLING CHARGE, REDUCED

MD-11, PROJECTILE, PROX.

MD11, PROJECTILE, PROX.

MD-81

MD81, PROJECTILE, PROX.

MD-11A, PROJECTILE, PROXIMITY/PD

N.E.W. 3.64 KG

## U.S.S.R. PROJECTILE, 130 MM, ILLUM, SP-46

Ordnance used with:

TM-16L, PROJECTILE, MT

M-1954, 130MM, FIELD GUN

M46, 130MM, FIELD GUN

TYPE 59, 130MM, FIELD GUN

TYPE 59-1, 130MM, FIELD GUN

M46, 130-MM, CARTRIDGE

M46, 130MM, PROPELLING CHARGE, FULL VARIABLE

N.E.W. 780.00 G

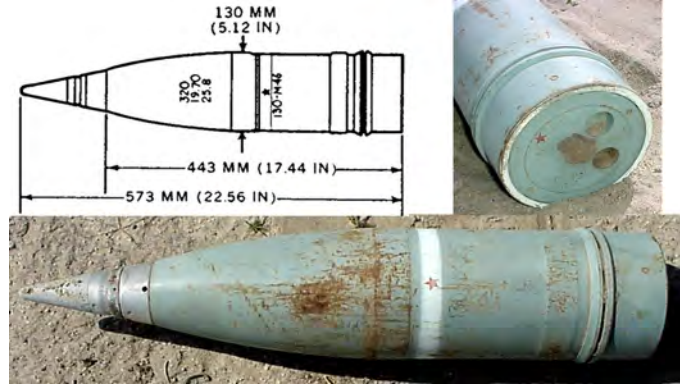

## U.S.S.R. PROJECTILE, 130-MM, FRAG, HE, OF-482M

Ordnance used with:

TYPE 59, 130MM, PROPEL. CHARGE, REDUCED VARIABLE

ZH 482U, 130MM, PROPELLING CHARGE, REDUCED

RGM-2, PROJECTILE, PD

RGM-3, PROJECTILE, PD

RGM-6, PROJECTILE, PD

AR 7 (SIGNAL), PROJECTILE, PROXIMITY/PD

UTIU M63P2, PROJECTILE, PD

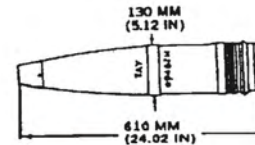

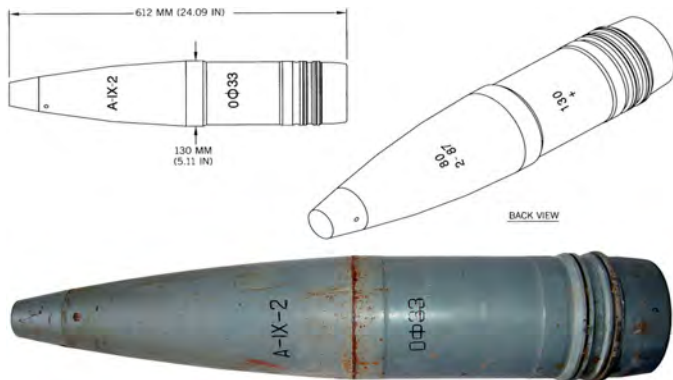

## U.S.S.R. PROJECTILE, 130-MM, FRAG, HE, OF33

Ordnance used with:  
 UTIU M63P2, PROJECTILE, PD  
 V-429, PROJECTILE, PD  
 V-429E, PROJECTILE, PD  
 B-90, PROJECTILE, MTSQ  
 V-90, PROJECTILE, MTSQ  
 AR 5, PROJECTILE, PROX.  
 AR-5, PROJECTILE, PROX.

N.E.W. 4.30 KG

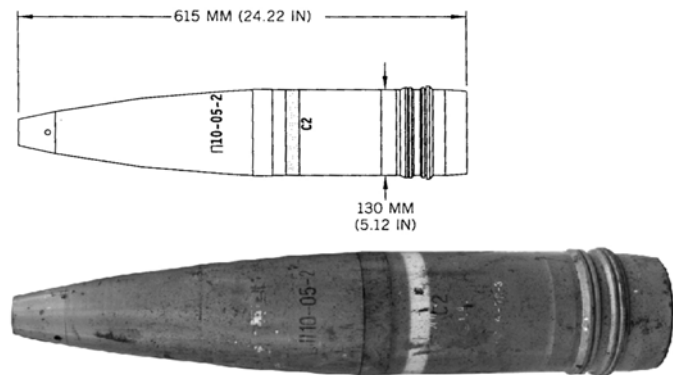

## U.S.S.R. PROJECTILE, 130-MM, ILLUMINATION, S2

Ordnance used with:  
 T-90, PROJECTILE, MT  
 B-90, PROJECTILE, MTSQ  
 V-90, PROJECTILE, MTSQ

N.E.W. 107.00 G



## IRAQI CARTRIDGE, 100-MM, FRAG, UO-415

Ordnance used with:  
O-415, 100-MM, FRAG  
O-415, 100-MM, HE-FRAG  
KS-19M2, AIR DEFENSE GUN, 100MM  
UO-415, 100-MM, HE, FRAG (IRAQI MODEL)

N.E.W. 7.05 KG

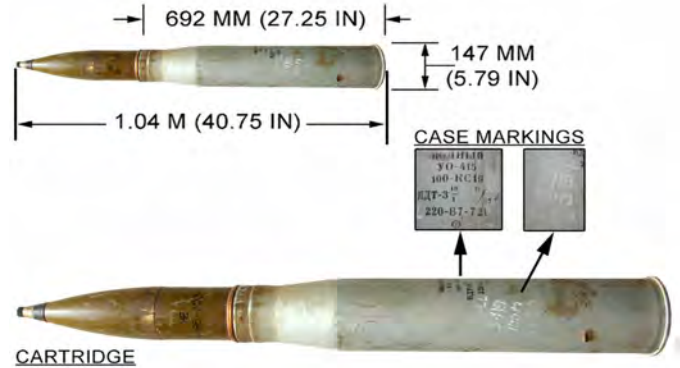

## U.S.S.R. CARTRIDGE, 100-MM, APFSDS-T, UBM-2

Ordnance used with:  
BM-2, 100-MM, APFSDS



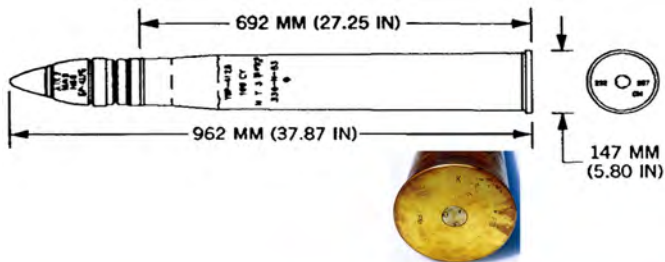

**U.S.S.R. CARTRIDGE, 100-MM, APHE OR APHE-T, UBR-412B**

Ordnance used with:  
 DBR-2, PROJECTILE, BD  
 BR-412B, 100-MM, APHE-T  
 MD-8, PROJECTILE, BD



**U.S.S.R. CARTRIDGE, 100-MM, HE, FRAG, UOF-412**

Ordnance used with:  
 NSC-1, PROJECTILE, PSD  
 OF-412, 100-MM, FRAG-HE  
 TYPE 412, PROJECTILE, 100 MM, HE  
 RGM, PROJECTILE, PD  
 RGM-2, PROJECTILE, PD  
 RGM-3, PROJECTILE, PD  
 RGM-6, PROJECTILE, PD



## U.S.S.R. CARTRIDGE, 100-MM, HEAT, UBK-2

Ordnance used with:  
GPV-2, PROJECTILE, PIBD, SPITBACK  
GPV-3, PROJECTILE, PIBD  
BK-3, 100-MM, HEAT-FS-T

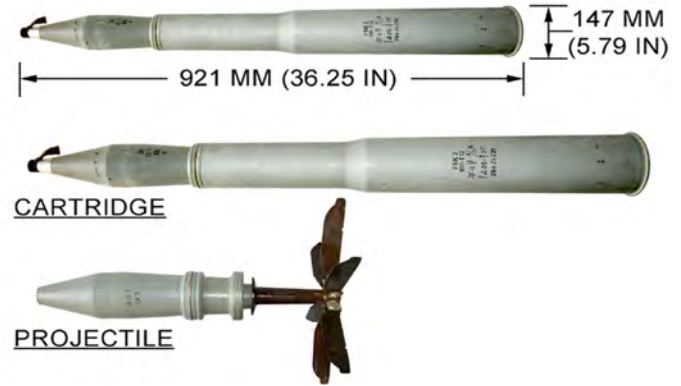

## U.S.S.R. CARTRIDGE, 100-MM, HEAT-FS, UBK-4M

Ordnance used with:  
GPV-2, PROJECTILE, PIBD, SPITBACK  
3BK-5M, 100MM, HEAT-FS-T  
3BK5M, 100MM, HEAT-FS-T  
BK-5M, 100MM, HEAT-FS-T  
BK5M, 100MM, HEAT-FS-T  
ZBK-5M, 100MM, HEAT-FS-T

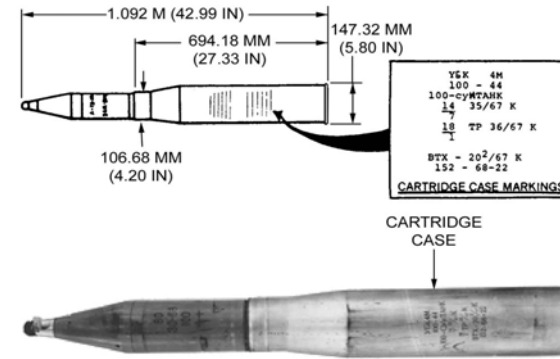

## U.S.S.R. CARTRIDGE, 122-MM, HEAT-FS-T, 3UBK-9



Ordnance used with:  
3BK-13, 122-MM, HEAT-FS-T  
BK-13, 122-MM, HEAT-FS-T  
BK13, 122-MM, HEAT-FS-T  
ZBK-13, 122-MM, HEAT-FS-T  
V-15, FUZE, PROJECTILE, PIBD  
ZH-9, 122 MM, PROPELLING CHARGE  
ZH-9, 122MM, PROPELLING CHARGE, FULL

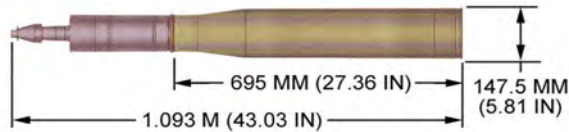

## RUSSIAN CARTRIDGE, 100-MM, HEAT, UBK-9M



Ordnance used with:  
V-15, FUZE, PROJECTILE, PIBD  
3BK17M, 100-MM, HEAT-T  
BK-17M

## U.S.S.R. CARTRIDGE, 100-MM, APFSDS-T, UBM-8

Ordnance used with:  
BM-20, 100-MM, APFSDS

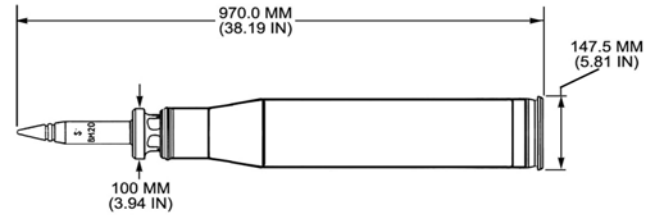

---

## CHINESE PROJECTILE, 152-MM, HE, TYPE 83

Ordnance used with:  
ML-7, PROJECTILE, PD  
ML7, PROJECTILE, PD

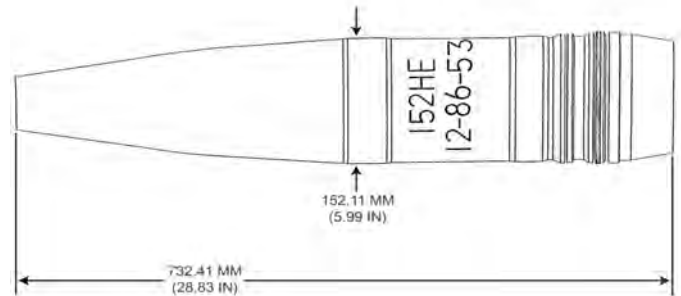

N.E.W. 6.60 KG

## RUSSIAN PROJECTILE, 152-MM, FRAG-HE, LASER-GUIDED, 3OF39 (KRASNOPOL)



IMAGES FROM RUSSIAN ARMS  
CATALOG, VOL. VII, REPRODUCED  
WITH PERMISSION FROM MILITARY  
PARADE PUBLISHING HOUSE.

## U.S.S.R. PROJECTILE, 152-MM, FRAG-HE, OF-530

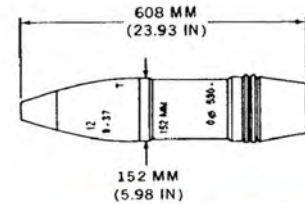

Ordnance used with:  
D-1, PROJECTILE, TSQ  
GVM, FUZE, PROJECTILE, PD  
GVMZ, FUZE, PROJECTILE, PD  
GVMZ-1, FUZE, PROJECTILE, PD  
RG-6, PROJECTILE, PD  
RGM, PROJECTILE, PD  
RGM-2, PROJECTILE, PD  
N.E.W. 6.90 KG

## U.S.S.R. PROJECTILE, 152-MM, FRAG-HE, OF-540

Ordnance used with:  
D-1, PROJECTILE, TSQ  
RGM-2, PROJECTILE, PD  
RGM-3, PROJECTILE, PD  
AR 7 (SIGNAL), PROJECTILE, PROXIMITY/PD  
UTIU M63P2, PROJECTILE, PD  
V-429, PROJECTILE, PD  
V-429E, PROJECTILE, PD

N.E.W. 5.70 KG

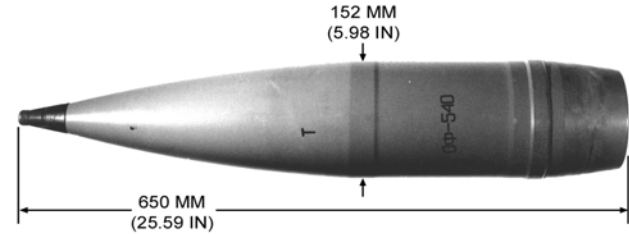

## U.S.S.R. PROJECTILE, 152-MM, HE-FRAG, OF25

Ordnance used with:  
RGM-2M, PROJECTILE, PD  
T-90, PROJECTILE, MT  
B-90, PROJECTILE, MTSQ  
V-90, PROJECTILE, MTSQ  
3OF32, 152MM, CARTRIDGE, FRAG-HE  
3VOF33, 152MM, CARTRIDGE, FRAG-HE  
NDT 3 16/1, CHARGE, PROPELLING, FULL, VARIABLE

N.E.W. 6.80 KG



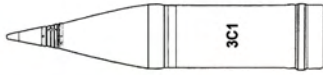

## U.S.S.R. PROJECTILE, 152-MM, ILLUMINATION, S1

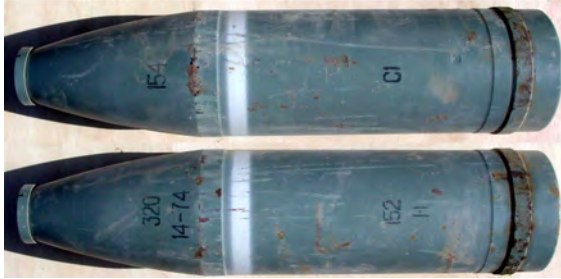

Ordnance used with:  
T-90, PROJECTILE, MT

---

## U.S.S.R. PROJECTILE, 160-MM, MORTAR, HE, F-853A

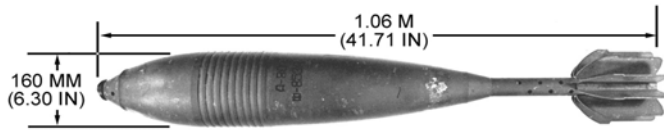

Ordnance used with:  
GVMZ-7, PROJECTILE, PD  
M-160, 160MM, MORTAR, TOWED  
TYPE 56, 160MM, MORTAR, TOWED

N.E.W. 7.73 KG



## U.S.S.R. PROJECTILE, 160-MM, MORTAR, HE, F-853U

Ordnance used with:  
GVMZ-7, PROJECTILE, PD

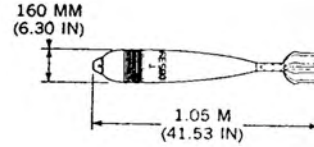

N.E.W. 8.99 KG

## U.S.S.R. CARTRIDGE, 115-MM, HE, FRAG, UOF-6

Ordnance used with:  
OF-18, 115-MM, HE-FRAG  
UTIU M63P2, PROJECTILE, PD  
V-429, PROJECTILE, PD  
V-429E, PROJECTILE, PD

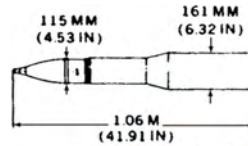

IRAQI COPY

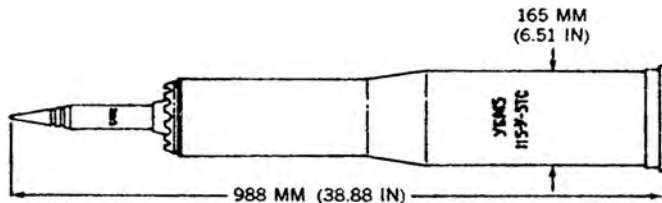

**U.S.S.R. CARTRIDGE, 115-MM, HVAP-FS-DS-T UBM-5**

Ordnance used with:  
BM-6, 115-MM, APFSDS-T



**U.S.S.R. CARTRIDGE, 115-MM, FS, HEAT, UBK-3M**



Ordnance used with:  
BK-4M, 115-MM, HEAT-FS  
GPV-2, PROJECTILE, PIBD, SPITBACK

N.E.W. 7.15 KG

**U.S.S.R. PROJECTILE, 240-MM, HE, MORTAR,  
GUIDED, 3F5 (SMEL'CHEK)**

Ordnance used with:  
T-90, PROJECTILE, MT  
M240, 240MM, MORTAR, TOWED  
2S4, 240MM, MORTAR, SELF-PROPELLED

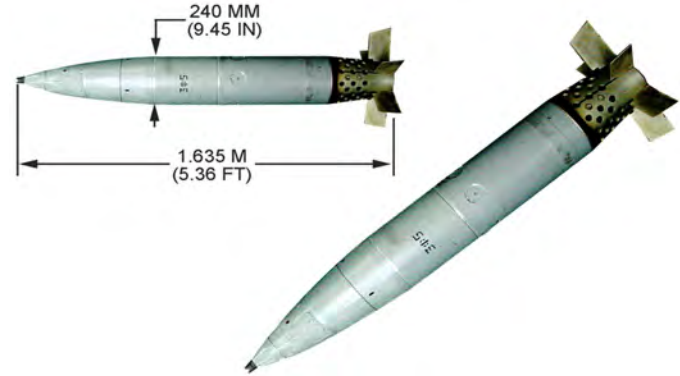

N.E.W. 32.00 KG

---

**U.S.S.R. PROJECTILE, 240-MM, MORTAR, HE, F864**

Ordnance used with:  
GVMZ-7, PROJECTILE, PD  
M16, PROJECTILE, PD

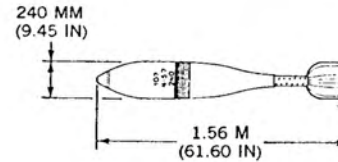

N.E.W. 31.93 KG

---

***THIS PAGE INTENTIONALLY LEFT BLANK***

## U.S.S.R. SUBMUNITION CANISTERS, MINE DISPENSING, EXPENDABLE, KSO-1 AND KSO-1S

Ordnance used with:  
POM-1, LANDMINE, APERS  
POM-1S, LANDMINE, APERS  
PKM, PORTABLE LANDMINE DISPENSING SYS.

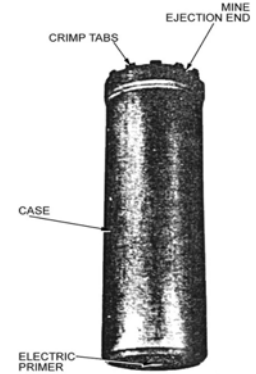
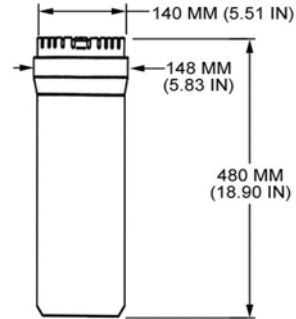

## U.S.S.R. SUBMUNITION CONTAINER UNIT, BOMB DISPENSING, EXPENDABLE, BFK PTAB-2.5 KO

Ordnance used with:  
KMGU  
KMGU-2, DISPENSER, CAPTIVE  
PTAB-2.5 KO, BOMB, HEAT/FRAG

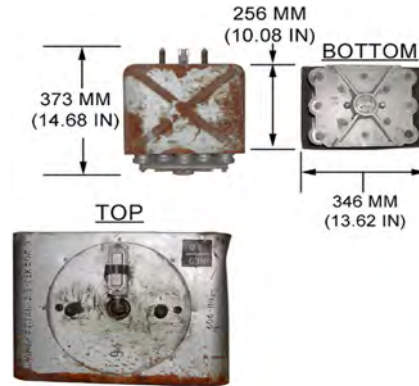

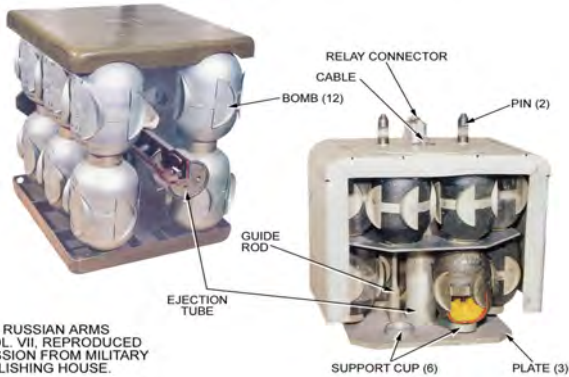

IMAGE FROM RUSSIAN ARMS CATALOG, VOL. VII, REPRODUCED WITH PERMISSION FROM MILITARY PARADE PUBLISHING HOUSE.

## U.S.S.R. SUBMUNITION CONTAINER UNIT, BOMB DISPENSING, EXPENDABLE, BKF AO-2.5 RT

Ordnance used with:

KMGU

KMGU-2, DISPENSER, CAPTIVE

AO 2.5 RT, BOMB, FRAG

549S, ACTUATOR MECHANISM ASSEMBLY, EXPLOSIVE,...

BR 549C RELAY MECHANISM

MN 549C ACTUATOR MECHANISM

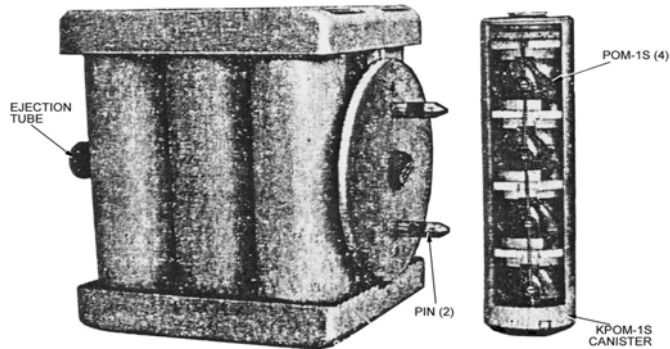

## U.S.S.R. SUBMUNITION CONTAINER UNIT, BOMB DISPENSING, EXPENDABLE, BFK POM-1S

Ordnance used with:

KMGU

KMGU-2, DISPENSER, CAPTIVE

POM-1S, LANDMINE, APERS

KPOM-1S, SUBMUN. CANISTER, MINE DISPENSING, E...

## U.S.S.R. SUBMUNITION CONTAINER UNIT, CANISTER DISPENSING, BKF-PFM-1S

Ordnance used with:  
 KMGU  
 KMGU-2, DISPENSER, CAPTIVE  
 GREEN PARROT  
 PFM-1S, LANDMINE, APERS  
 KPFM-1S, CANISTER, MINE DISPENSING

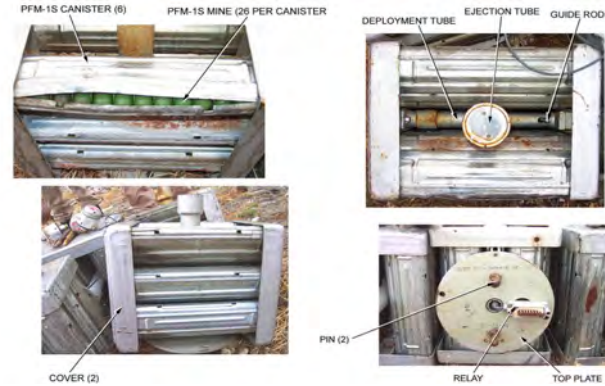

## U.S.S.R. CLUSTER ADAPTER, RBK-250 (OLD STYLE)

Ordnance used with:  
 PTAB 2.5, BOMB, HEAT 2.5 KG  
 TG 70, BOMB, HEAT 2.5 KG  
 TM-24B, BOMB, NOSE OR TAIL, MT  
 PTAB-1.5, HEAT  
 AO 2.5, BOMB, FRAG  
 PTAB-2.5M, BOMB, HEAT  
 PTAB-2.5, BOMB HEAT, SHORT TAIL

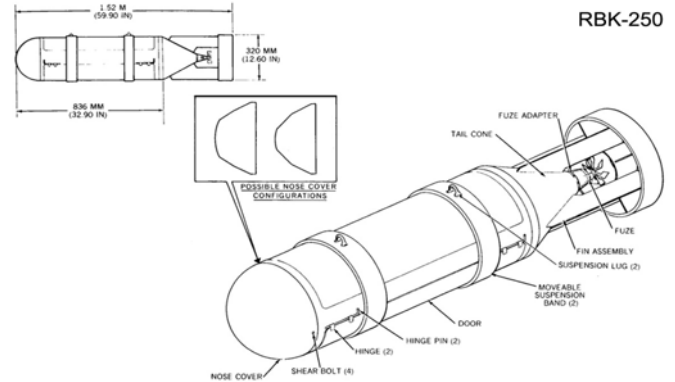

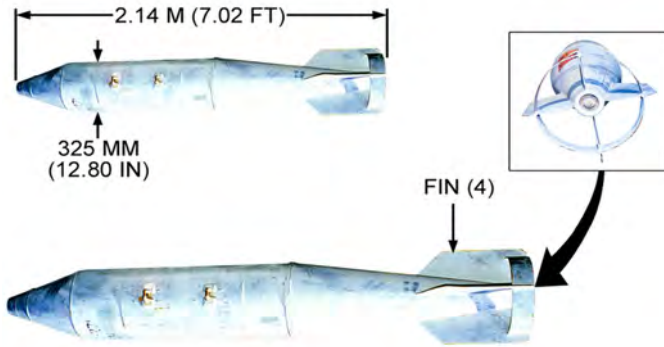

**U.S.S.R. BOMB DISPENSER, 250-KG, RBK-250-275**



**U.S.S.R. DISPENSER, RBK-250**

Ordnance used with:  
ATK-EB, FUZE, BOMB, MT  
ATM EB, BOMB, MT  
PTAB 2.5, BOMB, HEAT 2.5 KG  
TG 70, BOMB, HEAT 2.5 KG  
TM-24B, BOMB, NOSE OR TAIL, MT  
AO 2.5 2, BOMB FRAGMENTATION  
PTAB-2.5M, BOMB, HEAT



## U.S.S.R. DISPENSER, RBK-250-275

Ordnance used with:  
AO 1 SCH, BOMB, HE  
AO-1SCH  
ATK-EB, FUZE, BOMB, MT  
ATM EB, BOMB, MT  
TM-24B, BOMB, NOSE OR TAIL, MT  
PTAB-2.5M, BOMB, HEAT  
AO-10-6.5, BOMB, FRAG



## U.S. DISPENSER, LEAFLET, PDU-5/B (SUU-76C/B)

Ordnance used with:  
MK 339 MOD 0, MT  
MK 339 MOD 1, MT  
MK 7 MOD 3, DISP.  
SUU-76C/B

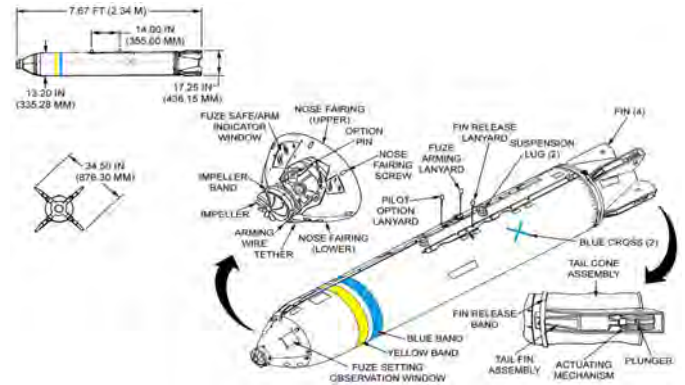

N.E.W. 27.90 G

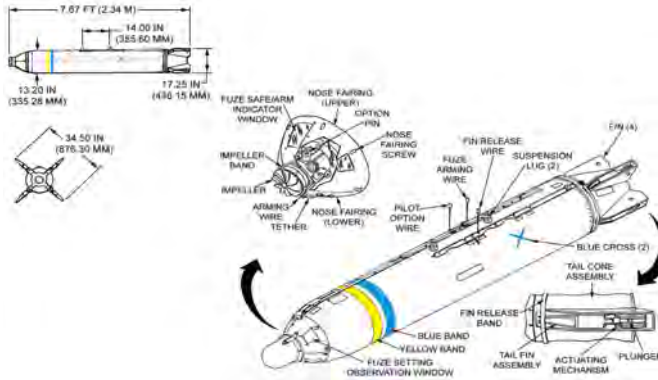

## U.S. DISPENSER, LEAFLET, SUU-76C/B

Ordnance used with:  
 MK 339 MOD 0, MT  
 MK 339 MOD 1, MT  
 MK 7 MOD 3, DISP.  
 PDU-5/B, DISPENSER, LEAFLET  
 SUU-76C/B (PDU-5/B), LEAFLET, CBU

N.E.W. 34.50 G

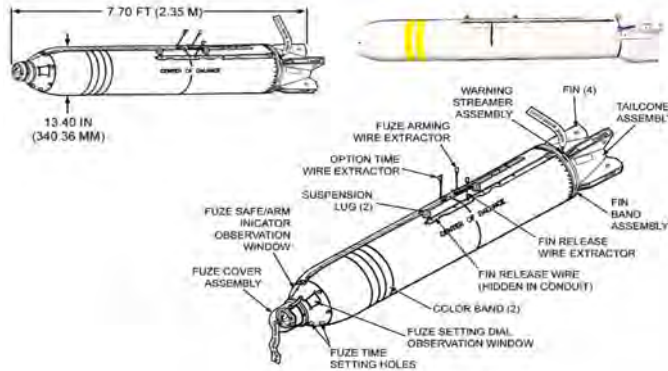

## U.S. DISPENSER, MK 7 MOD 11

Ordnance used with:  
 MK 339 MOD 0, MT  
 MK 339 MOD 1, MT  
 BOMB, AT, MK 118 MOD 0, ROCKEYE  
 MK 20 MOD 11 CBU

N.E.W. 18.50 G

## U.S. DISPENSER, MK 7 MOD 12 (ROCKEYE)

Ordnance used with:  
MK 339 MOD 0, MT  
MK 339 MOD 1, MT  
BOMB, AT, MK 118 MOD 0, ROCKEYE  
MK 20 MOD 12, CBU

N.E.W. 18.50 G

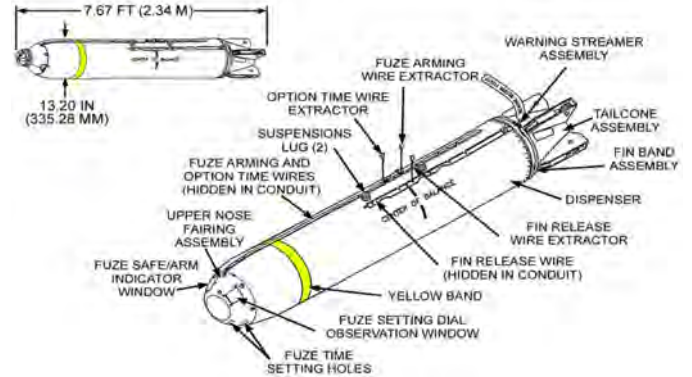

## U.S. DISPENSER, MK 7 MOD 7

Ordnance used with:  
MK 339 MOD 0, MT  
MK 339 MOD 1, MT  
BOMB, AT, MK 118 MOD 0, ROCKEYE  
MK 20 MOD 7 CBU

N.E.W. 18.50 G

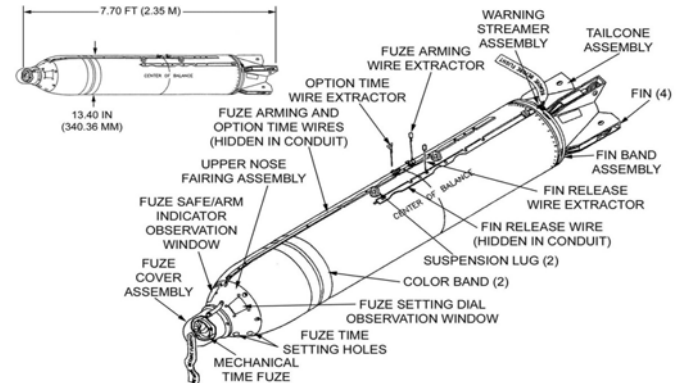

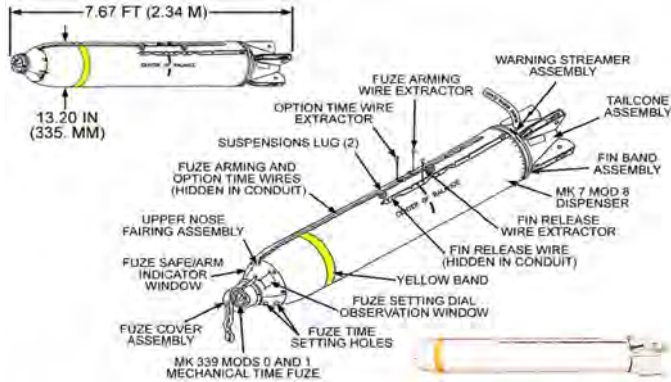

## U.S. DISPENSER, MK 7 MOD 8

Ordnance used with:  
 MK 339 MOD 0, MT  
 MK 339 MOD 1, MT  
 BOMB, AT, MK 118 MOD 0, ROCKEYE  
 MK 20 MOD 8 CBU  
 ROCKEYE

N.E.W. 100.79 LB

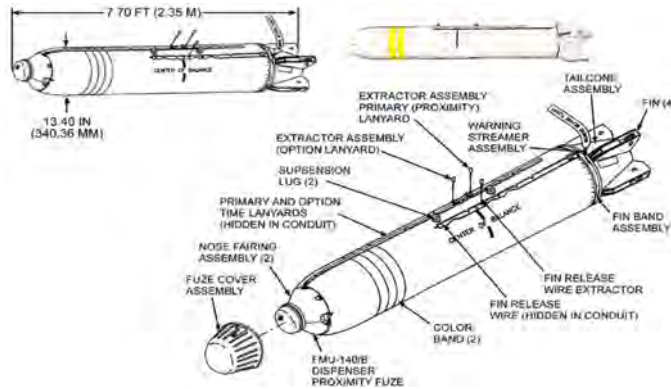

## U.S. DISPENSER, MK 7 MOD 9

Ordnance used with:  
 FMU-140/B, NOSE, PROX.  
 BOMB, AT, MK 118 MOD 0, ROCKEYE  
 MK 20 MOD 9 CBU

N.E.W. 18.50 G





## U.S. DISPENSER, MK 7 MOD 10

Ordnance used with:  
FMU-140/B, NOSE, PROX.  
MK 339 MOD 0, MT  
MK 339 MOD 1, MT  
BOMB, AT, MK 118 MOD 0, ROCKEYE  
MK 20 MOD 10 CBU

N.E.W. 18.50 G

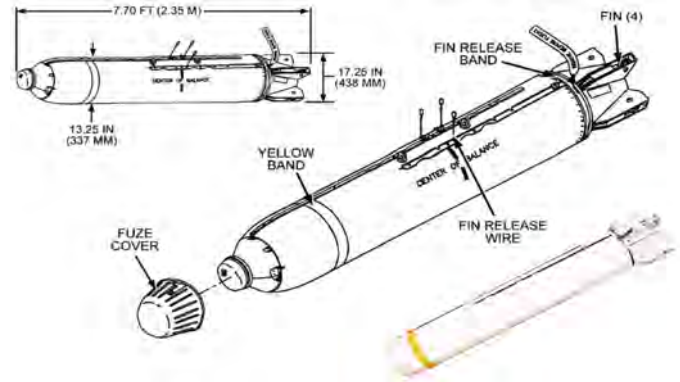

## U.S. DISPENSER, SUU-76A/B

Ordnance used with:  
FMU-140/B, NOSE, PROX.  
BOMB, AT, MK 118 MOD 0, ROCKEYE  
CBU-100A/B

N.E.W. 100.00 LB

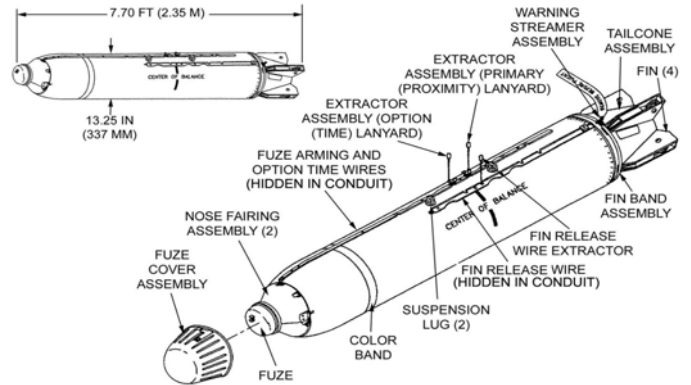

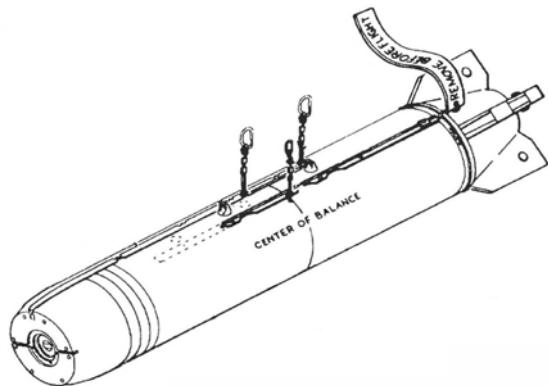

## U.S. DISPENSER, SUU-76B/B

Ordnance used with:  
CBU-100B/B

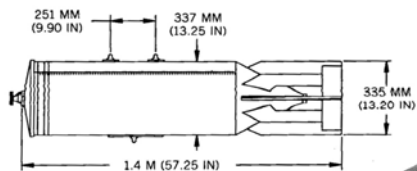

## U.S.S.R. CLUSTER, BOMB, FRAG, PROSAB-250

Ordnance used with:  
MDL. UNKNOWN, BOMB, 1.5-KG, FRAG  
TM-24A, BOMB, NOSE OR TAIL  
OKT-1.5, BOMB, CHEMICAL OR INCENDIARY

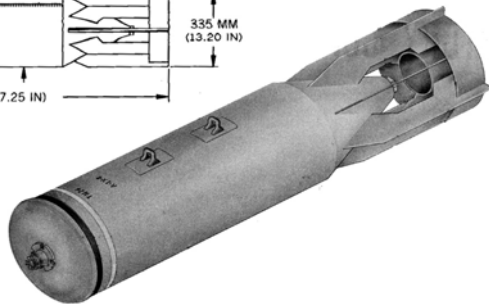



## U.S.S.R. SUBMUNITION CONTAINER UNIT, BOMB DISPENSING, EXPENDABLE, BFK PTAB-1M

Ordnance used with:  
KMGU  
KMGU-2, DISPENSER, CAPTIVE  
PTAB-1M, BOMB, HEAT

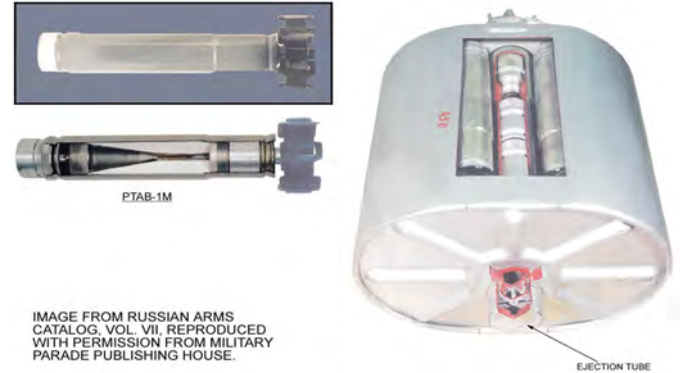

## TYPICAL CLUSTER, CLUSTER BOMB, OR CBU SYSTEM

Ordnance used with:  
MK 339 MOD 0, MT  
MK 339 MOD 1, MT  
MK 7 MOD 2, DISP.  
BOMB, AT, MK 118 MOD 0, ROCKEYE

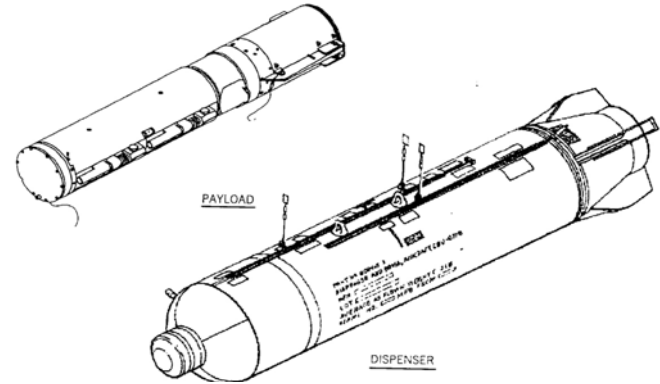

N.E.W. 100.00 LB



## U.S. CLUSTERS, CLUSTER BOMBS, AND CLUSTER BOMB UNIT (CBU) SYSTEMS; MK 20 MOD 3, 4, & 6 CB

Ordnance used with:  
MK 339 MOD 1, MT  
MK 7 MOD 4, DISP.  
MK 118, VECP MODIFIED, (ROCKEYE)  
BOMB, AT, MK 118 MOD 0, ROCKEYE  
BOMB, AT, MK 118 MOD 1, ROCKEYE  
NOTS 306A, LEAD

N.E.W. 100.00 LB

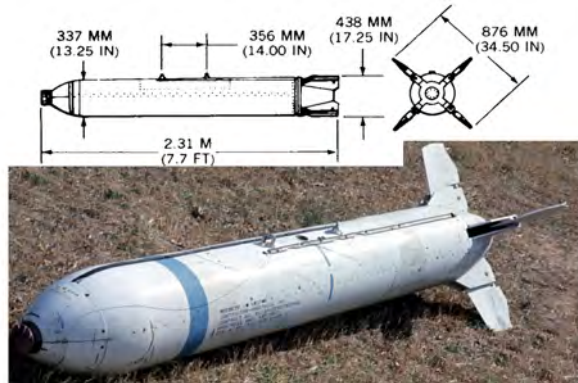

## U.S. DISPENSERS, MK 7 MODS 2, 3, 4 & 6

Ordnance used with:  
FMU-140/B, NOSE, PROX.  
MK 339 MOD 0, MT  
MK 339 MOD 1, MT  
SUU-58/B, DISP.  
BLU-77/B, BOMB UNIT, HEAT-FRAG  
BLU-91/B, BOMB, AT/AV  
GATOR

N.E.W. 18.50 G

## U.S.S.R. BOMB, CLUSTER, RBK-500 AO-2.5 RTM

Ordnance used with:  
AO 2.5 RTM, BOMB, FRAG  
AV-527, NOSE, ELEC.  
ATK-EA, FUZE, BOMB  
KP-527, EXPLOSIVE DISCONNECT/DEPLOYMENT MECHANISM

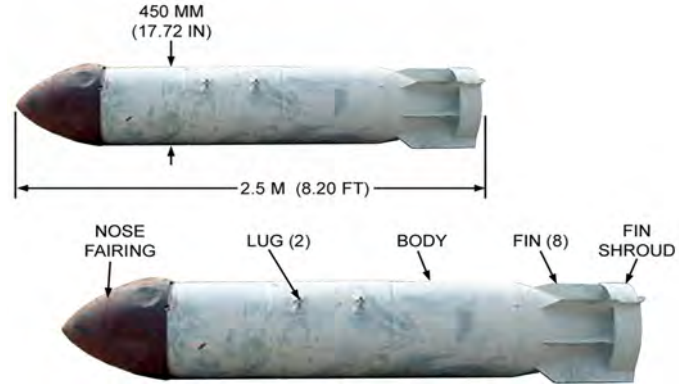

## U.S.S.R. CLUSTER BOMB UNIT, RBK-500 AO 2.5 RT

Ordnance used with:  
AO 2.5 RT, BOMB, FRAG  
AV-527, NOSE, ELEC.  
KP-527, EXPLOSIVE DISCONNECT/DEPLOYMENT MECHANISM



MARKINGS ON BACK



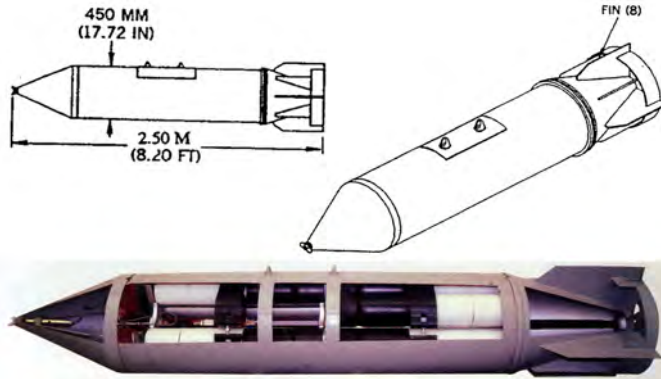

## U.S.S.R. DISPENSER, 500-KG, RBK-500

Ordnance used with:  
 AV-527, NOSE, ELEC.  
 KP-527, EXPLOSIVE DISCONNECT/DEPLOYMENT MECHANISM  
 UNDESIG, BOMB, CONCRETE PENETRATOR, (USED WIT...

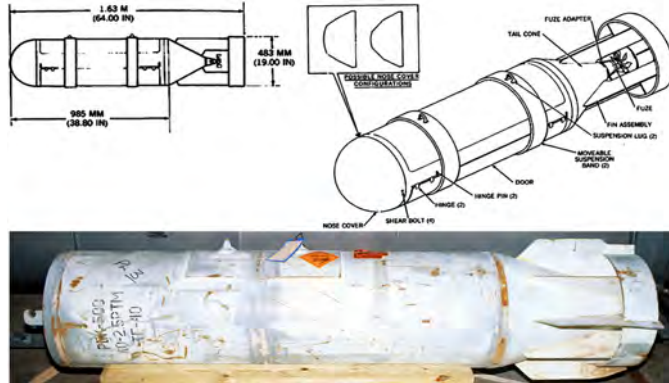

## U.S.S.R. CLUSTER ADAPTER, RBK-500 (OLD STYLE)

Ordnance used with:  
 PTAB 2.5, BOMB, HEAT 2.5 KG  
 TG 70, BOMB, HEAT 2.5 KG  
 TM-24B, BOMB, NOSE OR TAIL, MT  
 PTAB-1.5, HEAT  
 AO 2.5, BOMB, FRAG  
 PTAB-2.5M, BOMB, HEAT  
 PTAB-2.5, BOMB, HEAT, SHORT TAIL

## U.S.S.R. DISPENSER, CAPTIVE, KMGU-2

Ordnance used with:  
LBO, BOMB, FRAG, HE  
MN-121, LANDMINE, AT  
MI-24, HELICOPTER (HIND E)  
AO 2.5 RT, BOMB, FRAG  
AO 2.5 RTM, BOMB, FRAG  
PGMDM, LANDMINE, AT  
PTM-1, LANDMINE, AT  
N.E.W. 135.00 KG

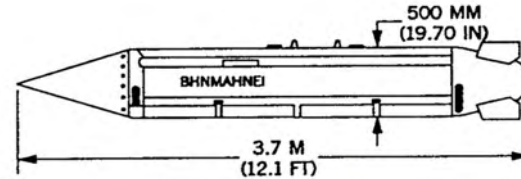

## U.S.S.R. LAUNCHER, UB-32A1

Ordnance used with:  
S-5KO, 57-MM, WARHEAD, HEAT-FRAG, A-TO-S  
S-5KPB, 57-MM, HEAT/FRAG, A-TO-S  
S-5M, 57-MM, HE, A-TO-S  
S-5KP, 57-MM, HEAT/FRAG, A-TO-S



## **U.S. CLUSTER BOMB UNIT (CBU) SYSTEMS; CBU-87/B**



Ordnance used with:  
SUU-65/B, DISP.  
BLU-97/B, BOMB FRAG/ HEAT  
FZU-39/B, PROX. SENSOR, CBU  
UNDESIGNATED, MT

N.E.W. 129.00 LB

---

## **U.S. CLUSTER BOMB UNIT (CBU) SYSTEMS; CBU-87 A/B**



Ordnance used with:  
SUU-65/B, DISP.  
BLU-97/B, BOMB FRAG/ HEAT  
FZU-39/B, PROX. SENSOR, CBU  
UNDESIGNATED, MT

N.E.W. 129.00 LB

---

## U.S. DISPENSER, AIRCRAFT, SUU-65/B

Ordnance used with:  
 BLU-97/B, BOMB FRAG/ HEAT  
 BLU-97A/B, BOMB, FRAG/HEAT  
 CBU-87/B  
 COMBINED EFFECTS MUNITION  
 CBU-87A/B  
 CBU-87B/B  
 FZU-39/B, PROX. SENSOR, CBU

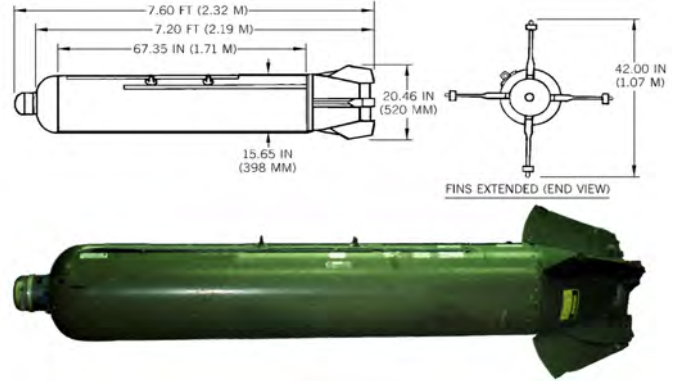

## U.S. DISPENSER, AIRCRAFT, SUU-65/B (WCMD)

Ordnance used with:  
 BLU-97/B, BOMB FRAG/ HEAT  
 BLU-97A/B, BOMB, FRAG/HEAT  
 CBU-103/B, (WCMD)  
 CBU-103A/B, (WCMD)  
 CBU-103B/B, (WCMD)  
 FZU-39/B, PROX. SENSOR, CBU  
 BLU-114/B, SUBMUNITION, ANTI-ELECTRICAL

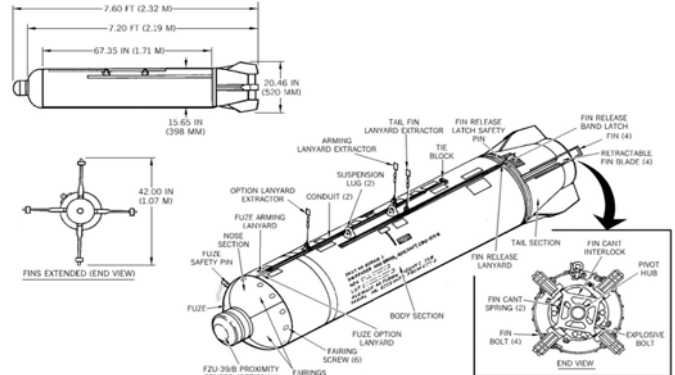

## U.S.S.R. LAUNCHER, ROCKET, 20-SHOT, B-8V20-A



Ordnance used with:

S-8K0M, 80-MM, HEAT/FRAG, A-TO-S

S-8KO, 80-MM, HEAT/FRAG, A-TO-S

S-8ASM, 80-MM, FLECHETTE, A-TO-S

S8ASM, 80-MM, FLECHETTE, A-TO-S

---



## U.S.S.R. BOMB, FAB-250 M46, GENERAL PURPOSE

Ordnance used with:  
APUV, NOSE & TAIL  
APUVM, BOMB, NOSE & TAIL  
AV 1, NOSE & TAIL  
AV 1 MODIFIED, BOMB, NOSE & TAIL  
AV 1D/U, BOMB, NOSE & TAIL  
AVDM, TAIL  
VDV, NOSE & TAIL  
N.E.W. 104.00 KG

---



## U.S.S.R. BOMB, GP, FAB-500 M54

Ordnance used with:  
ADP, TAIL  
APUV, NOSE & TAIL  
APUV-1, NOSE & TAIL  
APUVM, BOMB, NOSE & TAIL  
AVDM, TAIL  
AVT-E, NOSE & TAIL, IMPACT  
VDV, NOSE & TAIL  
N.E.W. 222.00 KG

---



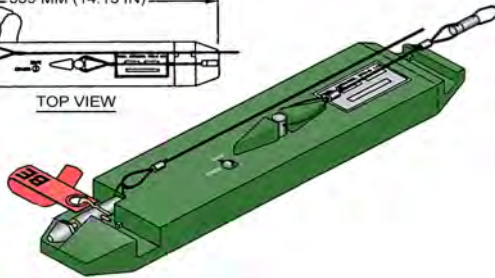
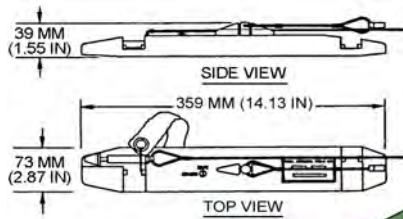

## U.S. TIMER ACTUATOR, DTU-31/B

Ordnance used with:  
BLU-111A/B, BOMB, GPLD, 500 LB  
MK 82, 500-LB, GP

---

DIMENSIONS UNKNOWN



## U.S.S.R. BOOSTER, INCENDIARY, PFK-ZB 250SH

Ordnance used with:  
AVU-ET, NOSE/TAIL, IMPACT  
AVU-ETM, BOMB FUZE  
ZB-500 SH, INCENDIARY

## U.S. BOMB UNITS, GUIDED, GBU-12B/B, GBU-12C/B, AND GBU-12D/B

Ordnance used with:

FMU-139/B, NOSE & TAIL, IMPACT

FMU-139A/B, NOSE & TAIL, IMPACT

FMU-26/B, BOMB FUZE, NOSE & TAIL, MULTIPURPOSE

FMU-26A/B, BOMB FUZE, NOSE & TAIL, MULTIPURPOSE

FMU-26B/B, BOMB FUZE, NOSE & TAIL, MULTIPURPOSE

FMU-81/B, BOMB FUZE, NS & TAIL, IMPACT, LG-DELAY

M905, TAIL, IMPACT

N.E.W. 88.00 KG

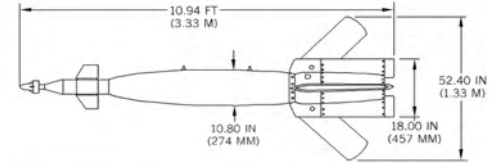

## U.S. BOMB UNITS, GUIDED, GBU-12/B & GBU-12A/B

Ordnance used with:

FMU-139/B, NOSE & TAIL, IMPACT

FMU-139A/B, NOSE & TAIL, IMPACT

FMU-26/B, BOMB FUZE, NOSE & TAIL, MULTIPURPOSE

FMU-26A/B, BOMB FUZE, NOSE & TAIL, MULTIPURPOSE

FMU-26B/B, BOMB FUZE, NOSE & TAIL, MULTIPURPOSE

FMU-81/B, BOMB FUZE, NS & TAIL, IMPACT, SRT-DELAY

M905, TAIL, IMPACT

N.E.W. 88.00 KG

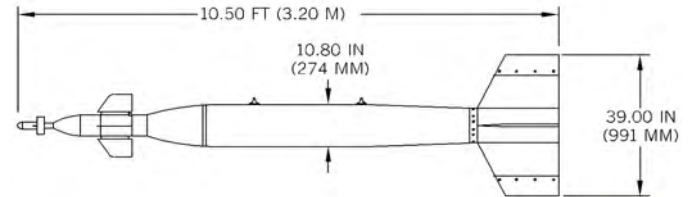

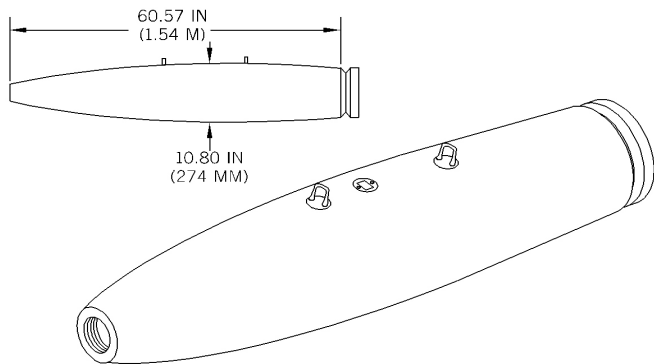

## U.S. BOMB, 500-LB, GP (LOW DRAG), BLU-111A/B

Ordnance used with:  
 DSU-33A(D-2)/B, SENSING ELEMENT, DUMMY  
 DSU-33A/B, SENSING ELEMENT, PROX.  
 FMU-139/B, NOSE & TAIL, IMPACT  
 FMU-139A/B, NOSE & TAIL, IMPACT  
 FMU-26/B, BOMB FUZE, NOSE & TAIL, MULTIPURPOSE  
 FMU-26A/B, BOMB FUZE, NOSE & TAIL, MULTIPURPOSE  
 FMU-26B/B, BOMB FUZE, NOSE & TAIL, MULTIPURPOSE  
 N.E.W. 87.10 KG

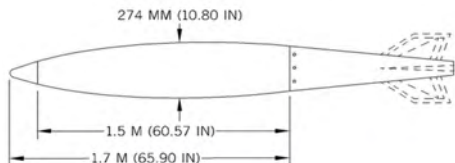

## U.S. BOMB, 500-LB, GP (LOW DRAG), MK 82

Ordnance used with:  
 AN-M166, NOSE, PROX.  
 BSU-49/B, FIN ASSEMBLY, AIR INFLATABLE RETARDER  
 BSU-86/B, FIN  
 DSU-30/B, BOMB TARGET DETECTING DEVICE  
 DSU-33A(D-2)/B, SENSING ELEMENT, DUMMY  
 DSU-33A/B, SENSING ELEMENT, PROX.  
 FMU-112/B, BOMB FUZE, NOSE & TAIL  
 N.E.W. 87.10 KG



## U.S.S.R. BOMB, PHOTOFLASH, FOTAB-100-80

Ordnance used with:  
AGDT A, BOMB, NOSE  
AGDT B, BOMB, NOSE  
TM-24A, BOMB, NOSE OR TAIL

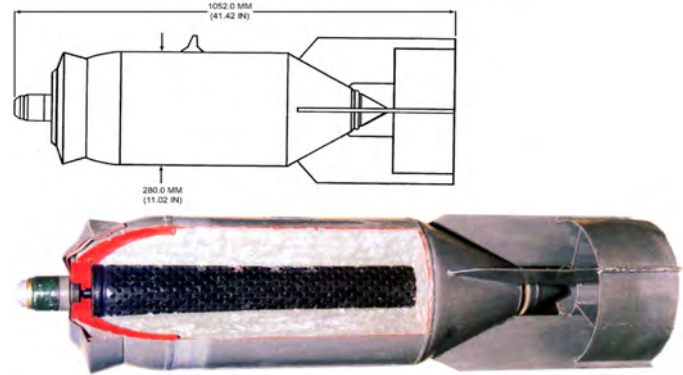

## U.S.S.R. BOMB, PHOTOFLASH, FOTAB-250T

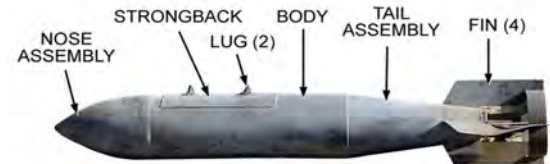

## U.S.S.R. BOMB, 250-KG, HE, FAB-250 M62

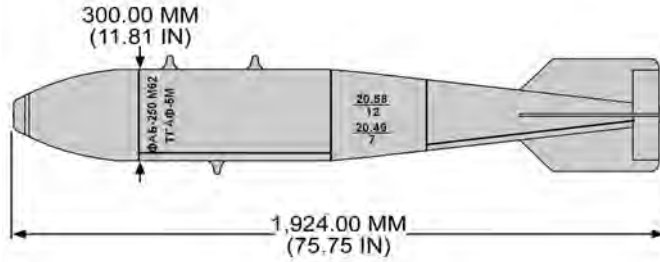

Ordnance used with:  
AVU-E, NOSE & TAIL  
VDV-1, NOSE & TAIL  
VDV 2, BOMB, NOSE & TAIL

N.E.W. 107.00 KG

## U.S.S.R. BOMB, FRAG HE, OFAB 250 SHN



Ordnance used with:  
AVU-529

N.E.W. 93.70 KG

## U.S.S.R. BOMB, FRAG, HE, 250-KG, OFAB-250-270

Ordnance used with:  
AM B, BOMB, NOSE  
AM B B/V, BOMB, NOSE  
APUV-1, NOSE & TAIL  
VDV, NOSE & TAIL  
VDV-1, NOSE & TAIL  
VDV 2, BOMB, NOSE & TAIL  
AVU-ET, NOSE/TAIL, IMPACT  
N.E.W. 94.00 KG

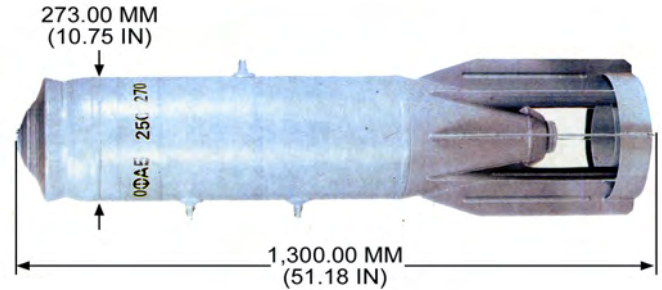

## U.S.S.R. BOMB, ILLUMINATION, SAB-250-200

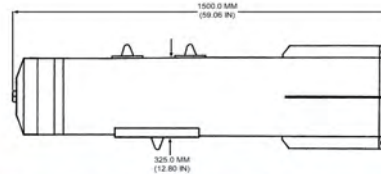

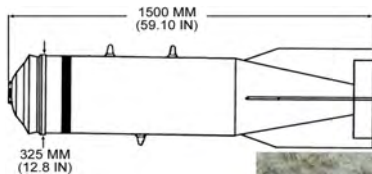

**U.S.S.R. BOMB, INCENDIARY, ZAB 250-200**

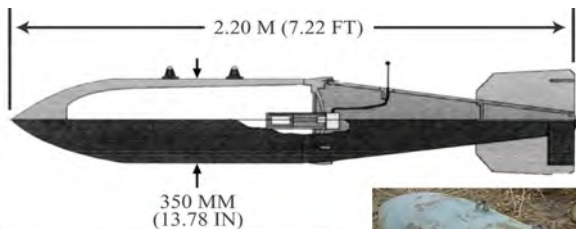

**U.S.S.R. BOMB, 478-KG, TARGET PENETRATION, BETAB-500**

N.E.W. 75.80 KG



## U.S. BOMB UNITS, GUIDED, GBU-16/B, GBU-16A/B, AND GBU-16B/B

Ordnance used with:

FMU-124A/B, NOSE & TAIL, IMPACT

FMU-139/B, NOSE & TAIL, IMPACT

FMU-139A/B, NOSE & TAIL, IMPACT

FMU-26/B, BOMB FUZE, NOSE & TAIL, MULTIPURPOSE

FMU-26A/B, BOMB FUZE, NOSE & TAIL, MULTIPURPOSE

FMU-26B/B, BOMB FUZE, NOSE & TAIL, MULTIPURPOSE

FMU-81/B, BOMB FUZE, NS & TAIL, IMPACT, LG-DELAY

N.E.W. 203.00 KG

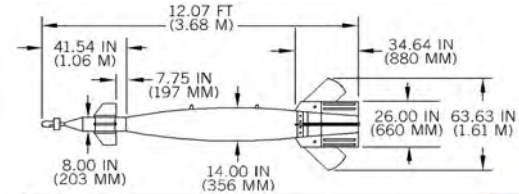

## U.S. BOMB, 1000-LB, GP (LOW DRAG), BLU-110A/B

Ordnance used with:

DSU-33A(D-2)/B, SENSING ELEMENT, DUMMY

DSU-33A/B, SENSING ELEMENT, PROX.

FMU-139/B, NOSE & TAIL, IMPACT

FMU-139A/B, NOSE & TAIL, IMPACT

FMU-26/B, BOMB FUZE, NOSE & TAIL, MULTIPURPOSE

FMU-26A/B, BOMB FUZE, NOSE & TAIL, MULTIPURPOSE

FMU-26B/B, BOMB FUZE, NOSE & TAIL, MULTIPURPOSE

N.E.W. 202.00 KG

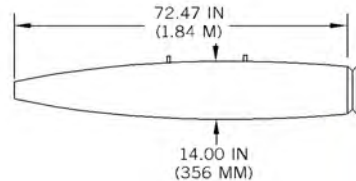

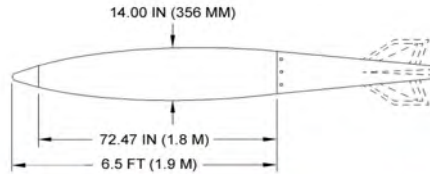

## U.S. BOMB, 1000-LB, GP (LOW DRAG), MK 83

Ordnance used with:

BSU-85/B, BOMB FIN ASSY, AIR INFLATABLE RETARDER

DSU-30/B, BOMB TARGET DETECTING DEVICE

DSU-33A(D-2)/B, SENSING ELEMENT, DUMMY

DSU-33A/B, SENSING ELEMENT, PROX.

FMU-112/B, BOMB FUZE, NOSE & TAIL

FMU-113/B, PROX.

FMU-124A/B, NOSE & TAIL, IMPACT

N.E.W. 202.00 KG

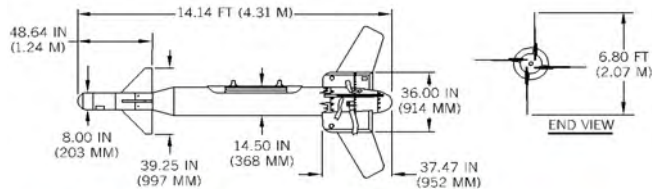

## U.S. BOMB UNIT, GUIDED, GBU-24A/B

Ordnance used with:

BLU-109/B, PENETRATOR

FMU-143/B, BOMB FUZE, NOSE & TAIL, IMPACT

FMU-143A/B, BOMB FUZE, NOSE & TAIL, IMPACT

FMU-143B/B, NOSE & TAIL, IMPACT

FMU-143D/B, BOMB FUZE, NOSE & TAIL, IMPACT

FMU-143E/B, NOSE & TAIL, IMPACT

FMU-143F/B, NOSE & TAIL, IMPACT

N.E.W. 243.00 KG

## U.S. BOMB UNIT, GUIDED, GBU-24B/B

Ordnance used with:  
BLU-109A/B, PENETRATOR  
FMU-143E/B, NOSE & TAIL, IMPACT  
FZU-32B/B, INITIATOR  
ADU-770/B, ADAPTER GROUP  
WGU-39B/B, GUIDANCE & CTRL. GROUP  
BSU-84A/B, AIRFOIL GROUP  
BLU-109/B BOMB PENETRATION

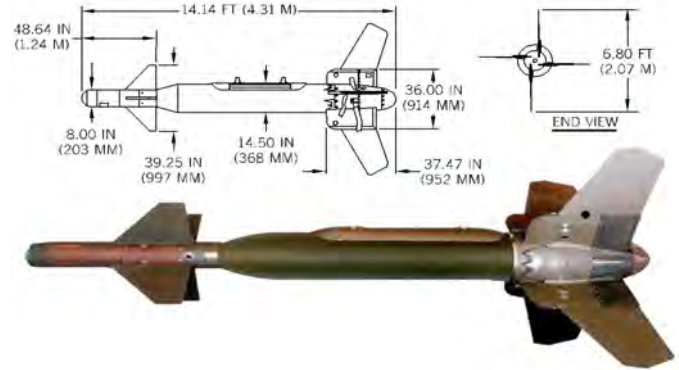

## U.S. BOMB UNIT, GUIDED, GBU-27/B

Ordnance used with:  
BLU-109/B, PENETRATOR  
FMU-124A/B, NOSE & TAIL, IMPACT  
FMU-139/B, NOSE & TAIL, IMPACT  
FMU-139A/B, NOSE & TAIL, IMPACT  
FMU-143/B, BOMB FUZE, NOSE & TAIL, IMPACT  
FMU-143B/B, NOSE & TAIL, IMPACT  
FMU-81/B, BOMB FUZE, NOSE & TAIL, IMPACT, SHO...  
N.E.W. 243.00 KG

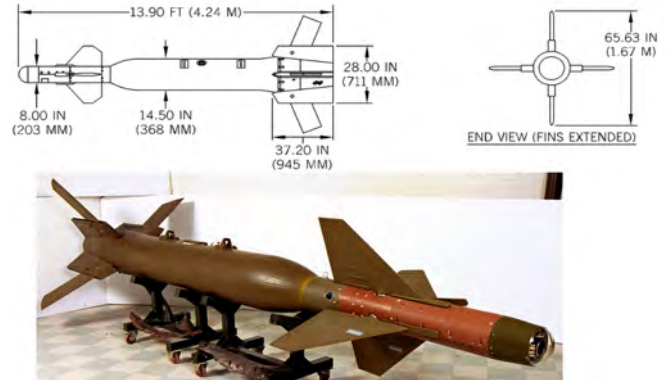

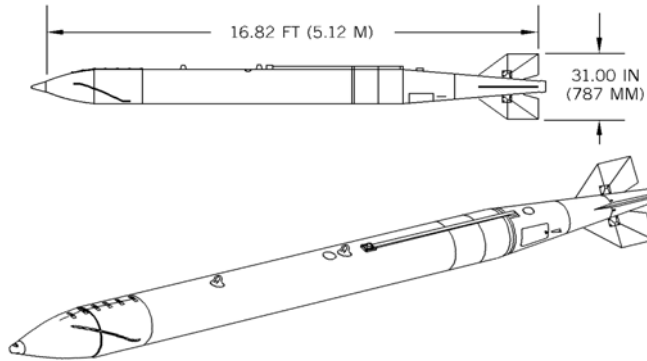

### U.S. BOMB UNIT, GUIDED, GBU-37/B

Ordnance used with:  
BLU-113/B, PENETRATOR  
BLU-113A/B, PENETRATOR  
FZU-32B/B, INITIATOR

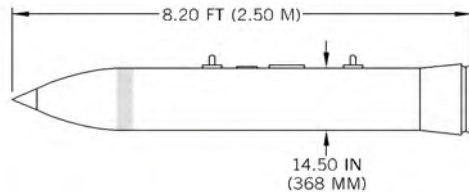

### U.S. BOMB UNIT, PENETRATOR, BLU-109/B

Ordnance used with:  
FMU-143/B, BOMB FUZE, NOSE & TAIL, IMPACT  
FMU-143A/B, BOMB FUZE, NOSE & TAIL, IMPACT  
FMU-143E/B, NOSE & TAIL, IMPACT  
GBU-10G/B, BOMB UNIT, GUIDED  
GBU-10H/B, BOMB UNIT, GUIDED  
GBU-10J/B, BOMB UNIT, GUIDED  
GBU-15(V)2/B



N.E.W. 243.00 KG

## U.S. BOMB UNIT, PENETRATOR, BLU-109A/B

Ordnance used with:  
FMU-143E/B, NOSE & TAIL, IMPACT  
GBU-10G/B, BOMB UNIT, GUIDED  
GBU-10H/B, BOMB UNIT, GUIDED  
GBU-10J/B, BOMB UNIT, GUIDED  
GBU-24B/B, BOMB UNIT, GUIDED  
GBU-31(V)3/B, GUIDED BOMB UNIT, JDAM  
GBU-31(V)4/B, GUIDED BOMB UNIT (JDAM)  
N.E.W. 243.00 KG

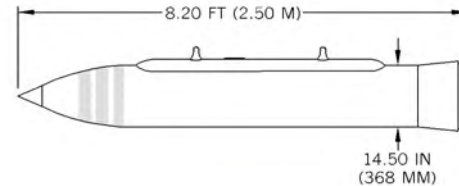

## U.S. BOMB UNITS, GBU-28/B AND GBU-28A/B

Ordnance used with:  
BLU-113/B, PENETRATOR  
BLU-113A/B, PENETRATOR  
FMU-143F/B, NOSE & TAIL, IMPACT  
FMU-143G/B, NOSE & TAIL, IMPACT  
FMU-143H/B, NOSE & TAIL, IMPACT  
FZU-48/B, INITIATOR  
FZU-32B/B, INITIATOR

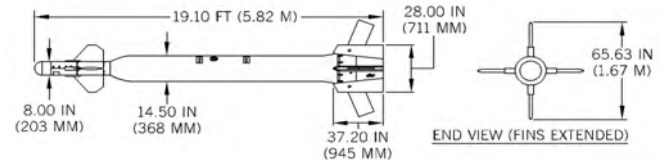

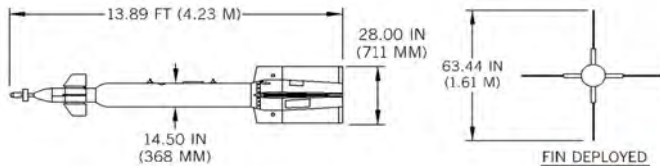

GBU-10G/B, -10H/B, AND -10

## U.S. BOMB UNITS, GUIDED, GBU-10G/B, H/B, & J/B

Ordnance used with:

BLU-109/B, PENETRATOR

BLU-109A/B, PENETRATOR

FMU-139A/B, NOSE & TAIL, IMPACT

FMU-143/B, BOMB FUZE, NOSE & TAIL, IMPACT

FMU-143B/B, NOSE & TAIL, IMPACT

MAU-169/B, COMPUTER CTRL. (CCG)

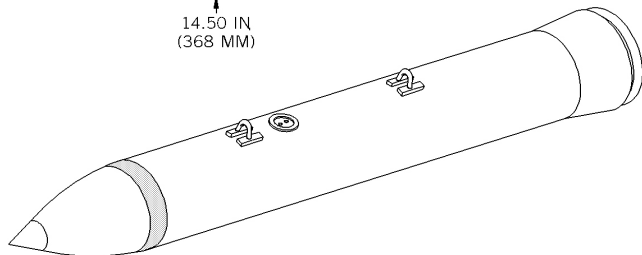
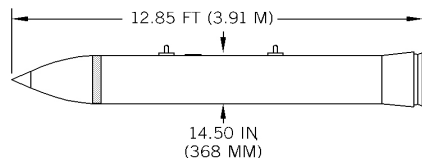

## U.S. BOMB UNITS, PENETRATOR, BLU-113/B AND BLU-113A/B

Ordnance used with:

FMU-143F/B, NOSE & TAIL, IMPACT

FMU-143G/B, NOSE & TAIL, IMPACT

FMU-143H/B, NOSE & TAIL, IMPACT

GBU-28/B

GBU-28A/B

GBU-37/B, GUIDED BOMB UNIT

FZU-48/B, INITIATOR

N.E.W. 299.00 KG

## U.S. BOMB, 2000-LB, PENETRATOR, BLU-118, THERMOBARIC

Ordnance used with:  
FMU-143J/B, NOSE & TAIL, IMPACT  
GBU-24H/B, GUIDED UNIT

N.E.W. 272.00 KG

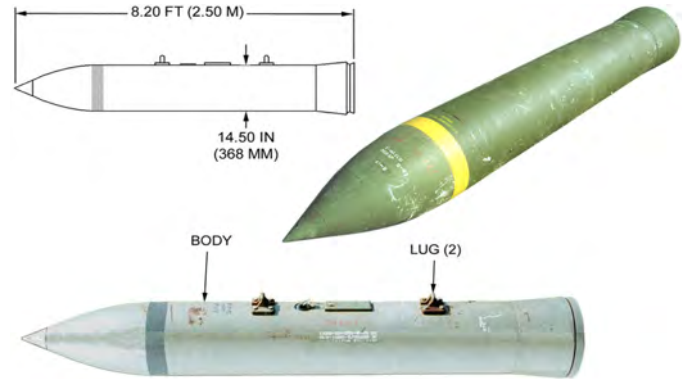

## U.S.S.R. BOMB, 500-KG, GP, FAB-500, M62

Ordnance used with:  
VDV, NOSE & TAIL  
AVU-ET, NOSE/TAIL, IMPACT  
AVU, BOMB, NOSE

N.E.W. 213.00 KG

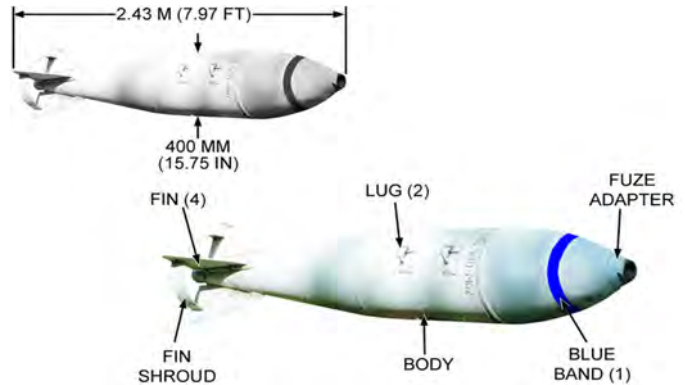

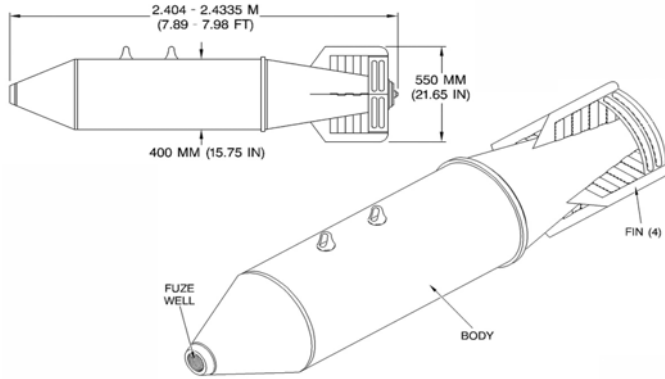

## U.S.S.R. BOMB, LEAFLET, AGITAB-500-300

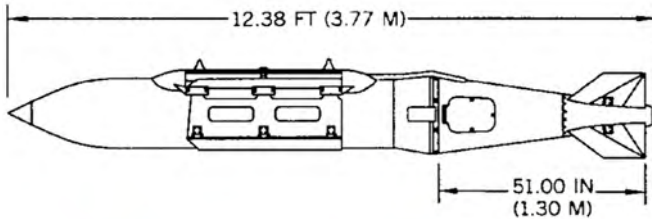

## U.S. BOMB UNITS, GUIDED, GBU-31(V)3/B AND GBU-31(V)4/B (JDAM)



Ordnance used with:  
 BLU-109/B, PENETRATOR  
 BLU-109A/B, PENETRATOR  
 FMU-143B/B, NOSE & TAIL, IMPACT  
 FMU-143E/B, NOSE & TAIL, IMPACT  
 FZU-55/B  
 FZU-32B/B, INITIATOR  
 KMU-557/B, GUIDANCE SET  
 N.E.W. 539.00 LB





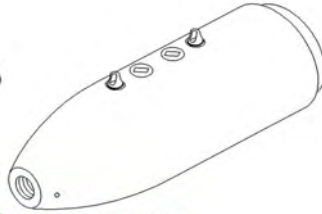
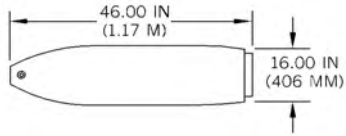

## U.S. BOMBS, 750-LB, GP, M117A1E1, M117A1E2, M117A1E3, M117A2 AND M117A3

Ordnance used with:

AN-M166, NOSE, PROX.

BSU-85/B, BOMB FIN ASSY, AIR INFLATABLE RETARDER

BSU-93/B, FIN ASSEMBLY, AIR INFLATABLE RETARDER

DSU-30/B, BOMB TARGET DETECTING DEVICE

DSU-33A(D-2)/B, SENSING ELEMENT, DUMMY

DSU-33A/B, SENSING ELEMENT, PROX.

FMU-112/B, BOMB FUZE, NOSE & TAIL

N.E.W. 172.00 KG

## U.S.S.R. BOMB, 500-KG, GP, FAB-500 SHN

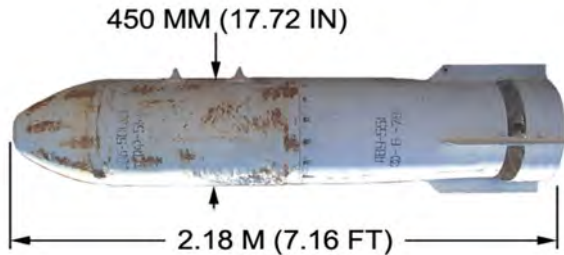

Ordnance used with:

UP-581, BOMB, FUZE

AVU-551, BOMB FUZE, TAIL

## U.S.S.R. BOMB, 1100-LB, GP, WELDED, FAB-500

Ordnance used with:  
AGP, BOMB, NOSE  
APUV, NOSE & TAIL  
APUV-1, NOSE & TAIL  
APUVM, BOMB, NOSE & TAIL  
AVU-E, NOSE & TAIL  
VDV, NOSE & TAIL  
AV 2 D/U, BOMB FUZE, NOSE & TAIL

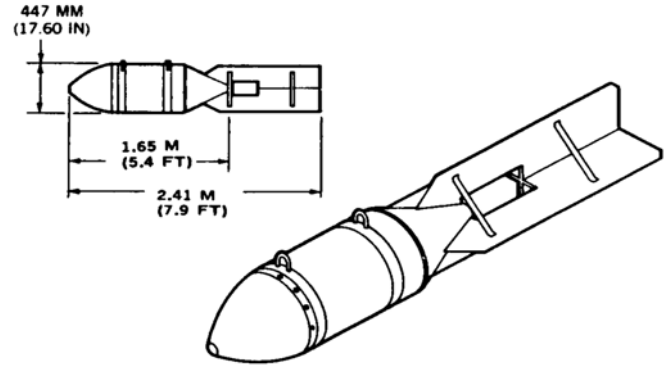

## U.S.S.R. BOMB, 500-KG, HE, PARACHUTE RETARDED, FAB-500SHL

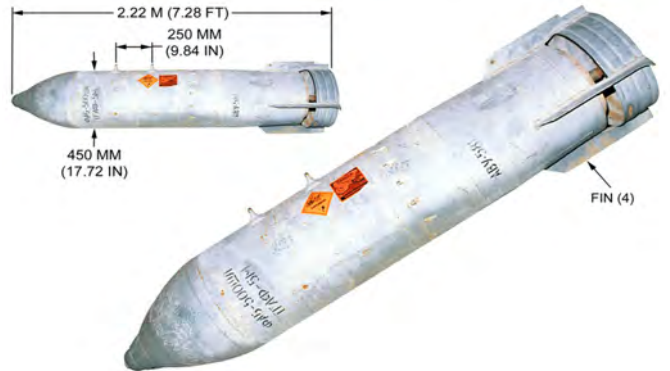

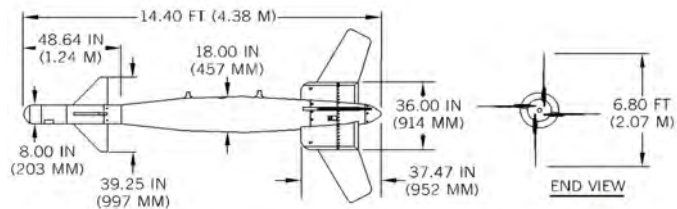

## U.S. BOMB UNIT, GUIDED, GBU-24/B

Ordnance used with:

- FMU-139/B, NOSE & TAIL, IMPACT
- FMU-139A/B, NOSE & TAIL, IMPACT
- FMU-143/B, BOMB FUZE, NOSE & TAIL, IMPACT
- FMU-143A/B, BOMB FUZE, NOSE & TAIL, IMPACT
- FMU-143B/B, NOSE & TAIL, IMPACT
- FMU-143D/B, BOMB FUZE, NOSE & TAIL, IMPACT
- FMU-143E/B, NOSE & TAIL, IMPACT

N.E.W. 430.00 KG

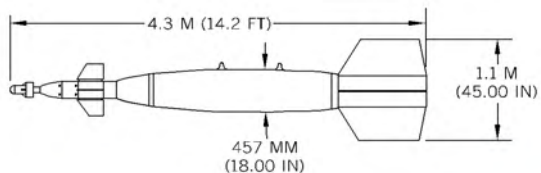

## U.S. BOMB UNITS, GUIDED, GBU-10/B & GBU-10A/B

Ordnance used with:

- FMU-139/B, NOSE & TAIL, IMPACT
- FMU-139A/B, NOSE & TAIL, IMPACT
- FMU-26/B, BOMB FUZE, NOSE & TAIL, MULTIPURPOSE
- FMU-26A/B, BOMB FUZE, NOSE & TAIL, MULTIPURPOSE
- FMU-26B/B, BOMB FUZE, NOSE & TAIL, MULTIPURPOSE
- FMU-81/B, BOMB FUZE, NS & TAIL, IMPACT, SRT-DELAY M905, TAIL, IMPACT

N.E.W. 430.00 KG

## U.S. BOMB UNITS, GUIDED, GBU-10C/B, D/B, AND E/B

Ordnance used with:

FMU-139/B, NOSE & TAIL, IMPACT

FMU-139A/B, NOSE & TAIL, IMPACT

FMU-143/B, BOMB FUZE, NOSE & TAIL, IMPACT

FMU-143B/B, NOSE & TAIL, IMPACT

FMU-26B/B, BOMB FUZE, NOSE & TAIL, MULTIPURPOSE

FMU-81/B, BOMB FUZE, NS & TAIL, IMPACT, SRT-DELAY

M905, TAIL, IMPACT

N.E.W. 430.00 KG

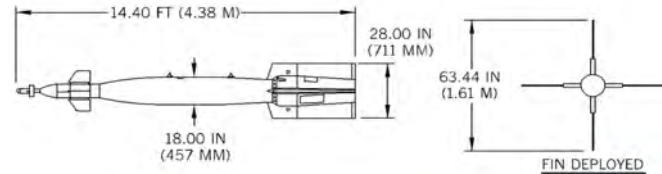

## U.S. BOMB UNITS, GUIDED, GBU-31(V)1/B AND GBU-31(V)2/B (JDAM)

Ordnance used with:

DSU-33A/B, SENSING ELEMENT, PROX.

FMU-139A/B, NOSE & TAIL, IMPACT

DSU-33B/B, SENSING ELEMENT, PROX.

FMU-139B/B, BOMB, NOSE/TAIL

MK 84, 2000-LB, GP

BLU-117A/B, GENERAL PURPOSE, 2,000-LB,

FZU-48/B, INITIATOR

N.E.W. 945.00 LB

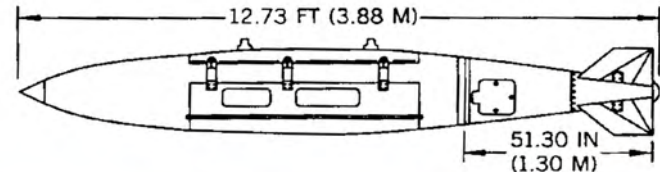

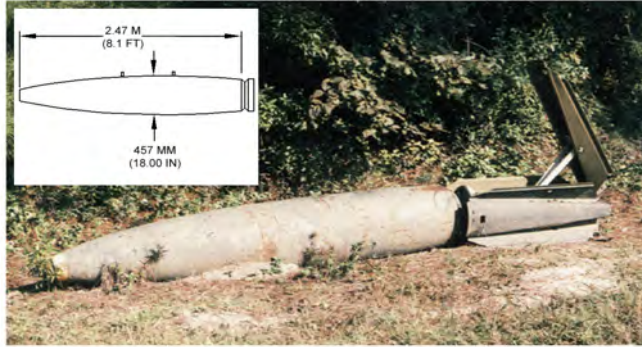

## U.S. BOMB, 2000-LB, GP (LOW DRAG), MK 84

Ordnance used with:

AN-M166, NOSE, PROX.

BSU-50/B, FIN ASSEMBLY, AIR INFLATABLE RETARDER

DSU-30/B, BOMB TARGET DETECTING DEVICE

DSU-33A(D-2)/B, SENSING ELEMENT, DUMMY

DSU-33A/B, SENSING ELEMENT, PROX.

FMU-112/B, BOMB FUZE, NOSE & TAIL

FMU-113/B, PROX.

N.E.W. 429.00 KG

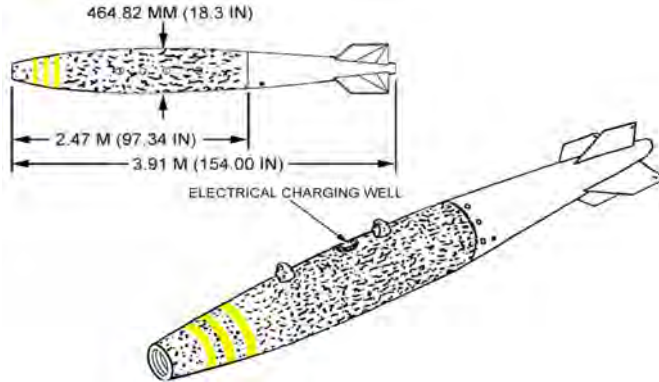

## U.S. BOMB, 2000-LB, GP, BLU-117A/B

Ordnance used with:

FMU-139/B, NOSE & TAIL, IMPACT

FMU-139A/B, NOSE & TAIL, IMPACT

GBU-10/B, BOMB UNIT, GUIDED

GBU-10A/B, BOMB UNIT, GUIDED

GBU-10C/B, BOMB UNIT, GUIDED

GBU-10D/B, BOMB UNIT, GUIDED

GBU-10E/B, BOMB UNIT, GUIDED

N.E.W. 901.00 LB

## U.S.S.R. BOMB, 500-KG, FAE, ODAB-500PM

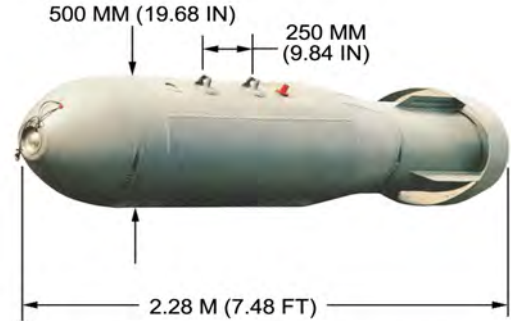

"Image from Russian Arms Catalog, Vol. #VII, reproduced with Permission from Military Parade Publishing House."

N.E.W. 193.00 KG

## U.S.S.R. BOMB, 500-KG, INCENDIARY, ZB-500 SH

Ordnance used with:  
PF.K ZB-500SH, BOOSTER, INCENDIARY

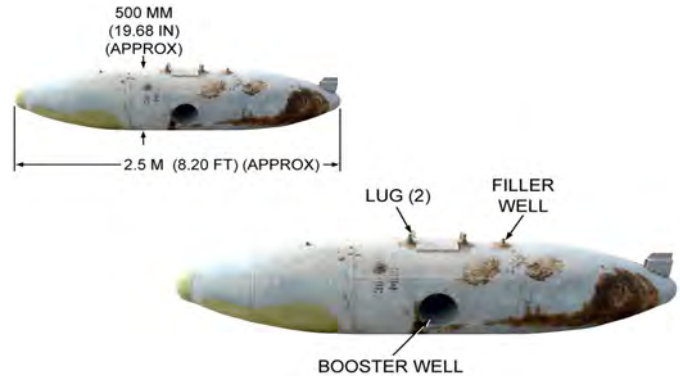

## U.S.S.R. BOMB, INCENDIARY, ZB 500 GD

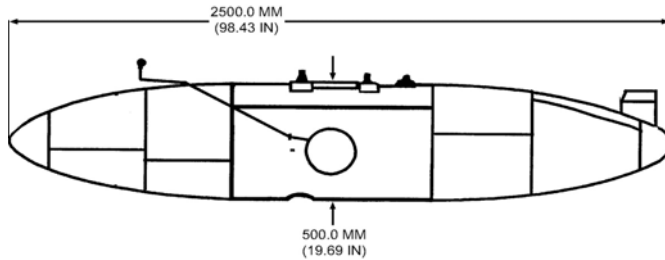

## U.S.S.R. BOMB UNIT, GUIDED, 1,500-KG, HE, KAB-1500KR



Ordnance used with:  
UNKNOWN, BOMB, HE, 1500 KG  
SEEKER, TV GUIDED, KAB-1500  
CTRL. SECTION KAB-1500KR

IMAGE FROM RUSSIAN ARMS CATALOG, VOLUME VII, REPRODUCED WITH PERMISSION FROM MILITARY PARADE PUBLISHING HOUSE.



## U.S.S.R. BOMB UNIT, GUIDED, HE-FRAG, KAB-1500L-F

Ordnance used with:  
UNKNOWN, COMPUTER CTRL. GROUP  
UNKNOWN, WING ASSY.

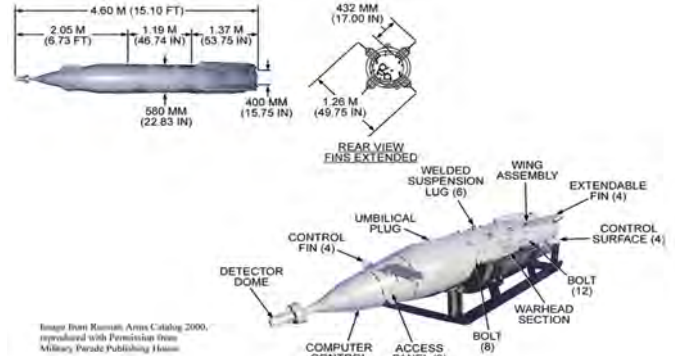

N.E.W. 1180.00 KG

## U.S. BOMB UNIT, BLAST, CRADLED, 15,000-LB, BLU-82/B

Ordnance used with:  
M904E1, NOSE  
M904E2, NOSE  
M904E3, NOSE  
M904E4, NOSE  
M905, TAIL, IMPACT  
M.905, TAIL, IMPACT  
T771E4, TAIL, IMPACT

N.E.W. 5717.84 KG

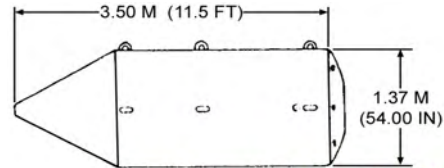

***THIS PAGE INTENTIONALLY LEFT BLANK***

## U.S.S.R. BOMB, FRAG, AO-2.5

Ordnance used with:  
AGM 1, BOMB, NOSE  
AGM 3, BOMB, NOSE  
AM B, BOMB, NOSE  
AM B B/V, BOMB, NOSE  
TM-4A, NOSE, MT  
RBK-250, CLUSTER, ADAPTER  
RBK-500, DISP. (OLD STYLE)  
N.E.W. 0.09 KG

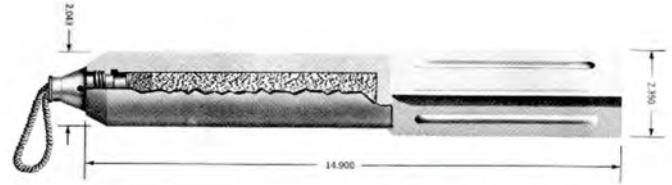

## U.S.S.R. BOMB, HE, AO-1

Ordnance used with:  
RBK-250-275, DISP.  
RBK-250, DISP.



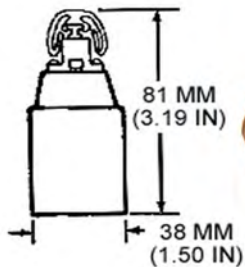

### U.S. GRENADE, DP, M42

Ordnance used with:  
M483, 155-MM, HE  
M483A1, 155-MM, HE  
M509A1, 8-INCH, HE  
M864, 155-MM, HE, EXTENDED RANGE  
FIROS-30, 122-MM, ICM  
FIROS-25, 122-MM, ICM  
M223, GRENADE FUZE, IMPACT

N.E.W. 33.00 G

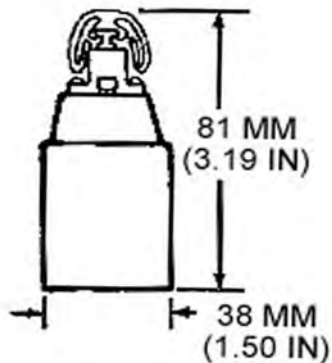

### U.S. GRENADE, DP, M46

Ordnance used with:  
M483, 155-MM, HE  
M483A1, 155-MM, HE  
M509A1, 8-INCH, HE  
M864, 155-MM, HE, EXTENDED RANGE  
MK 146 MOD 2, 16-IN, HE  
NR269, 155MM, ERFB-BB, HE-ICM  
M223, GRENADE FUZE, IMPACT

N.E.W. 33.00 G

## YUGOSLAV GRENADE, DP, KB-1

Ordnance used with:  
ABABEL 50, 262MM, HE, M87  
KRTM-M93, RIFLE, 40MM, HEAT-APERS  
M93, 40MM, RIFLE, HEAT-APERS  
M87, 262MM, HE

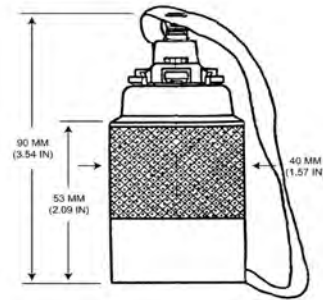

N.E.W. 35.00 G

## U.S.S.R. BOMB, HEAT, PTAB-1M

Ordnance used with:  
KMGU  
KMGU-2, DISPENSER, CAPTIVE  
RBK-500 PTAB-1M, CBU  
BKF PTAB-1M, SUBMUN. CONTAINER UNIT, BOMB DIS...

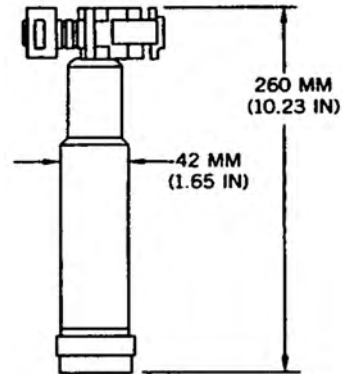

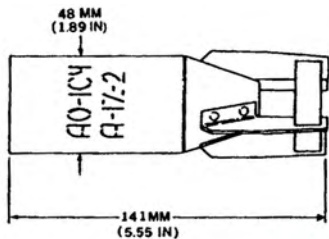

## U.S.S.R. BOMB, HE, AO-1 SCH

Ordnance used with:  
 AM-A, BOMB, NOSE  
 AM A B/V, BOMB, NOSE  
 RBK-250-275, DISP.

N.E.W. 51.00 G

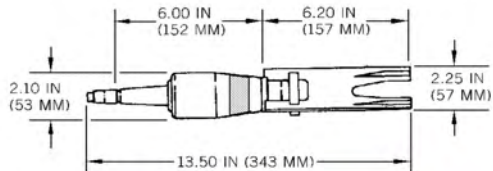

## U.S. BOMB, HEAT/FRAG, MK 118 MODS 0 & 1

Ordnance used with:  
 MK 7 MOD 2, DISP.  
 MK 7 MOD 3, DISP.  
 MK 7 MOD 4, DISP.  
 MK 7 MOD 6, DISP.  
 GRM, CLUSTER, GUIDED ROCKEYE MUNITION  
 MK 20 MOD 2 CBU  
 MK 20 MOD 3 CBU

N.E.W. 175.00 G

## U.S. BOMB, HEAT/FRAG, VECP MODIFIED

Ordnance used with:

MK 7 MOD 2, DISP.  
MK 7 MOD 3, DISP.  
MK 7 MOD 4, DISP.  
MK 7 MOD 6, DISP.  
MK 20 MOD 4 CBU  
KMU-388/B, LASER GUIDANCE KIT,  
MK 96 MOD 0, ELEC. DET.

N.E.W. 185.50 G

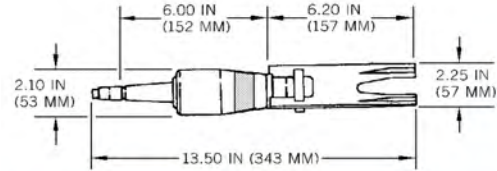

## U.S.S.R. BOMB, HEAT/FRAG, PTAB-2.5KO

Ordnance used with:

KMGU  
KMGU-2, DISPENSER, CAPTIVE  
I-351A, IMPACT  
I-351AM, IMPACT, SD  
BKF PTAB-2.5 KO, SUBMUN. CTR UNIT, BOMB DISPE...

N.E.W. 200.00 G

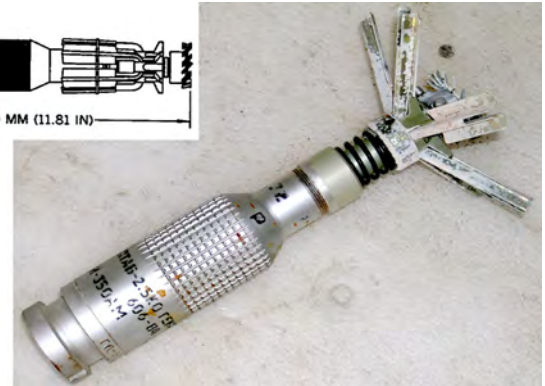
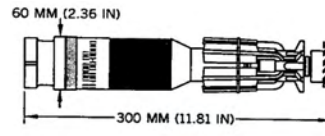

## U.S.S.R. LANDMINE, APERS, PFM-1 (BIRDMINE)

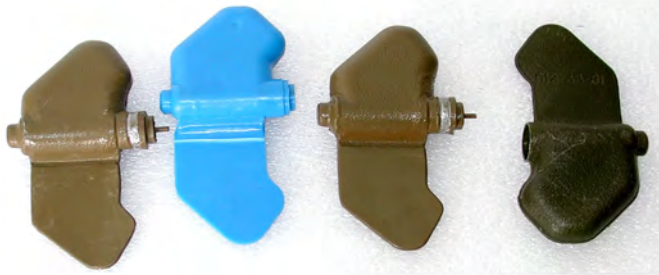

Ordnance used with:  
KMGU  
KMGU-2, DISPENSER, CAPTIVE  
PKM, PORTABLE LANDMINE DISPENSING SYS.  
KSF-1, SUBMUN. CANNISTER, MINE DISPENSING, EX...

---

## U.S.S.R. LANDMINE, SCATTERABLE, AT, PTM-1 (PGMDM)



Ordnance used with:  
KMGU  
KMGU-2, DISPENSER, CAPTIVE  
9M27K2, 220 MM, CARGO  
MVDM, TIME/PRESSURE/SD  
9N128K2, WARHEAD, 220MM, CARGO  
BKF PTM-1S, SUBMUN. CONTAINER UNIT, MINE DISP...



**U.S. BOMB UNITS, LIVE, FRAG/HEAT, BLU-97/B,  
BLU-97A/B, AND BLU-97B/B; BOMB UNITS, TRAINING,  
BLU-97(T-1)/B, BLU-97(T-1)A/B, BLU-97(T-2)/B**

Ordnance used with:

SUU-65/B, DISP.

MK 10 MOD 0, MISSILE CANISTERING SYS. (USED ...

RGM-109D-3, GUIDED MISSILE, S-TO-S (TOMAHAWK)

RGM-109D-31, GUIDED MISSILE, S-TO-S (TOMAHAWK)

RGM-109D-4, GUIDED MISSILE, S-TO-S (TOMAHAWK)

RGM-109D-41 GUIDED MISSILE, S-TO-S (TOMAHAWK)

UGM-109D-1, GUIDED MISSILE, SUBMARINE-TOSURFA...

N.E.W. 10.00 OZ

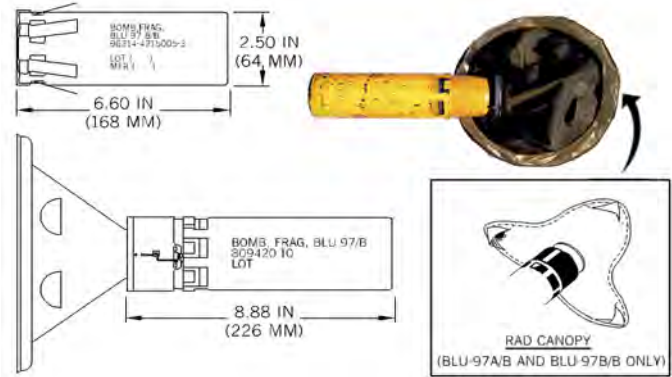

**U.S.S.R. BOMB, FRAG, 1.5-KG, MODEL UNKNOWN**

Ordnance used with:

PROSAB-250, CBU

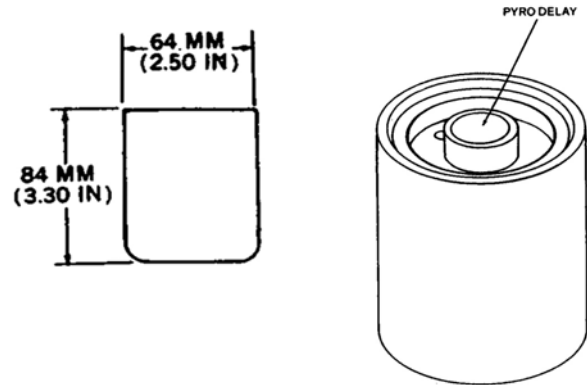

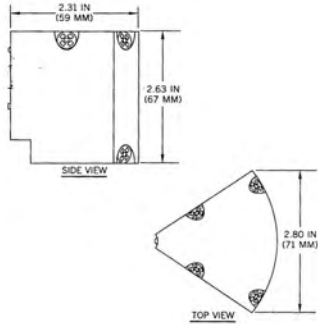

## U.S. LANDMINE, APERS, M86

N.E.W. 21.00 G



## U.S.S.R. LANDMINES, APERS, POM-1 AND POM-1S

Ordnance used with:

KMGU

KMGU-2, DISPENSER, CAPTIVE

PKM, PORTABLE LANDMINE DISPENSING SYS.

KSO-1, SUBMUN. CANISTER, MINE DISPENSING, EXP...

KSO-1S, SUBMUN. CANISTER, MINE DISPENSING, EX...

PKPI, DISPENSER, CAPTIVE, HELICOPTER MOUNTED

PKPI-1

N.E.W. 100.00 G

**ITALIAN LANDMINE, APERS, ANTI-DISTURBANCE,  
SB-33/AR; PORTUGUESE M412; SPANISH P-5; AND  
GREEK EM-20**

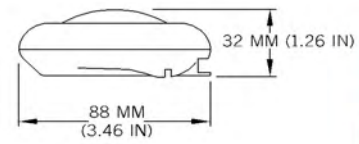
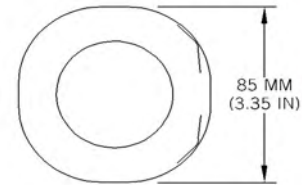

N.E.W. 17.00 G

**ITALIAN LANDMINE, APERS, SB-33; PORTUGUESE  
M412; AND SPANISH P-5**

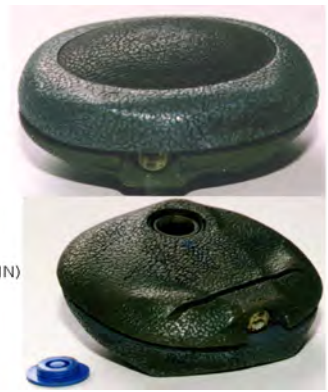
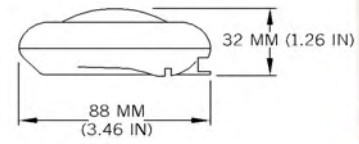
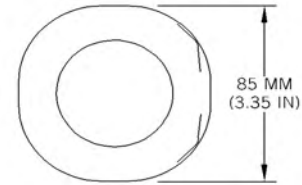

N.E.W. 36.00 G

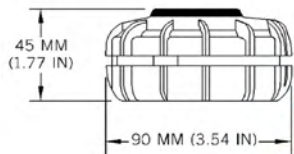

## EGYPTIAN LANDMINE, APERS, T/79

Ordnance used with:  
VS-AR4, ANTILIFT DEVICE

N.E.W. 54.00 G

---

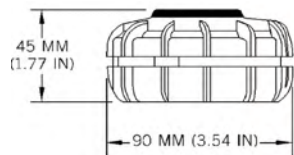

## IRANIAN LANDMINE, APERS, YM-I

Ordnance used with:  
VS-AR4, ANTILIFT DEVICE

N.E.W. 54.00 G

---

## ITALIAN LANDMINE, APERS, VS-50; AND TRAINING

Ordnance used with:  
VS-AR4, ANTILIFT DEVICE

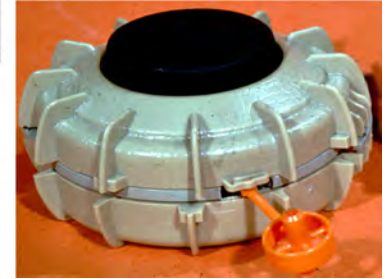
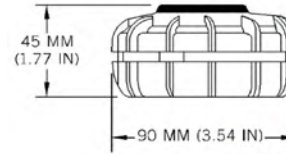

N.E.W. 44.00 G

## ITALIAN LANDMINES, APERS TS-50; AND TRAINING

Ordnance used with:  
VS-AR4, ANTILIFT DEVICE

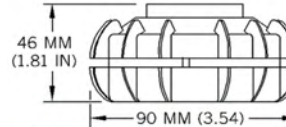

N.E.W. 54.00 G

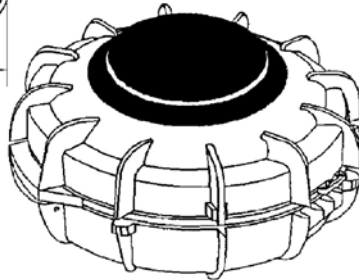
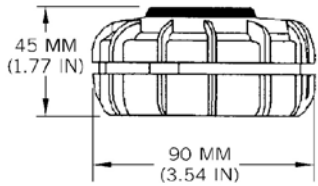

**SINGAPORE LANDMINE; APERS, SPM-1**

N.E.W. 44.00 G

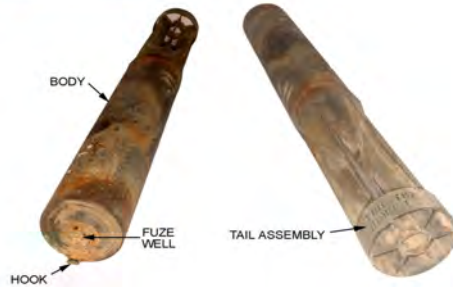
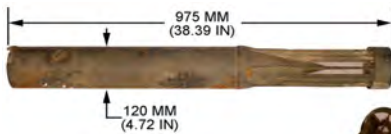

**U.S.S.R. BOMB, HE, FRAG, AO-25-33**

N.E.W. 6.25 KG

## U.S.S.R. CANISTER, MINE-DISPENSING, KPFM-1

Ordnance used with:

KMGU

KMGU-2, DISPENSER, CAPTIVE

PFM-1, LANDMINE, APERS

BKF PFM-1, SUBMUN. CONTAINER UNIT, CANISTER D...

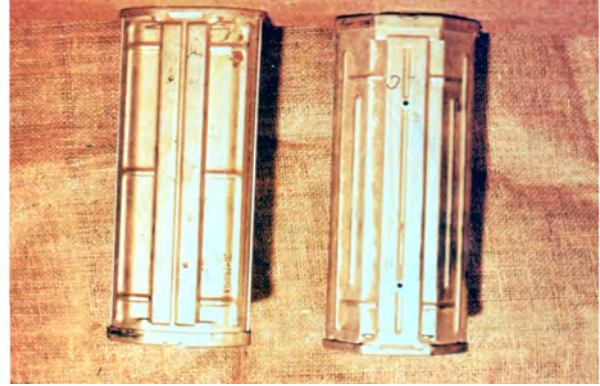

## U.S.S.R. CANISTER, MINE-DISPENSING, KPFM-1S

Ordnance used with:

KMGU

KMGU-2, DISPENSER, CAPTIVE

BKF PFM-1S, SUBMUN. CONTAINER UNIT, CANISTER ...





SUSPENSION ASSEMBLY

"Image from Russian Arms Catalog, Vol. 7, reproduced with permission from Military Parade Publishing House."



SUSPENSION ASSEMBLY

FUZE ASSEMBLY

WARHEAD

## U.S.S.R. BOMB, THERMOBARIC, BKF ODS-OD, PARACHUTE ASSEMBLY, ODS-OD

Ordnance used with:

KMGU

KMGU-2, DISPENSER, CAPTIVE

BKF ODS-OD, BOMB, THERMOBARIC

MDL. UNK. (ODS-OD)

MDL. UNKNOWN, CYLINDER

MDL. UNKNOWN, BURSTER/IGNITER ASSY.

BKF ODS-OD SUBMUN. CONTAINER UNIT, BOMB DISPE...



## U.S.S.R. LANDMINE, APERS, POM-2S

Ordnance used with:

9M18, 122 MM, MINE DISPENSING, APERS

PKM, PORTABLE LANDMINE DISPENSING SYS.

PKPI, DISPENSER, CAPTIVE, HELICOPTER MOUNTED

PKPI-1

UMZ, MULTI-PURPOSE MINE LAYER